



**AFZAL**  
SURGICAL INST

Manufacturer & Exporters of Dental Instruments



# DENTAL

## Instruments Catalogue



## TABLE OF CONTENTS

01	Tooth Extraction Forceps	01-49
02	Root Elevators	50-70
03	Scalpel Handles, Handles, Mouth Mirrors Scalers, Explorer / Probes	71-85
04	Endodontic Condensers, Obturation Instruments Excavators, Explorer / Probes, Curette Sets	86-96
05	Amalgam Pluggers / Condensers, Burnishers	97-100
06	Wax Carvers, Carvers, Chisels	101-103
07	Compsite Placement, Plastic Filling Instruments	104-107
08	Curettes, Gracey Curettes, Dental Products, Knives	108-117

---

---

## TABLE OF CONTENTS

09	Wax Porcelain & Cement Instruments Wax & Modelling Instruments	118-121
10	Spatulas, Cement Spatulas	122-124
11	Files, Hoes, Knives, Wax & Plaster Knives, Crane Kaplan	125-128
12	Bone Curettes, Bone Files, Bone Chisels, Bone Mallets	129-133
13	Crown Removers, Crown Instruments	134-136
14	Implant & Measuring Instruments, Suction Tubes, Bone Gauges	137-144
15	Amalgam Guns & Carriers, Retainers, Bands, Strip Holders, Napkin Holders	145-146
16	Rubber Dam Instruments, Rubber Dam Clamps	147-148

---

---

## TABLE OF CONTENTS

17	Syringes, Tweezers, Sterilizing & Lab Instruments	149-156
18	Endodontic Forceps, Tissue Forceps, Haemostatic Forceps, Towel Clamps	157-159
19	Retractors, Lip & Cheek Retractors, Hooks, Depressors & Mouth Gags, Sterilizing Forceps	160-164
20	Orthodontic Pliers & Cutters, Rongeurs	165-179
21	Needle Holders, Scissors, Micro Surgery Set	180-186
22	Impression Trays	187-193
23	Articulators, Hollow Ware	194-200
24	Scissors, Dissecting Forceps, Needle Holders, Wire Cutting Pliers With Tungsten Carbide Inserts	201-213

---

---

# SECTION 01



- ▶ Extraction Forceps
- ▶ Root Elevators



## Extraction Forceps "English Pattern"



**1001**  
Fig. 4  
lower incisor



**1001**  
Fig. 4  
lower incisor



**1002**  
Fig. 8  
lower premolar



**1002**  
Fig. 8  
lower premolars

## Extraction Forceps "English Pattern"



**1003**  
Fig. 1  
upper centrals & canines



**1004**  
Fig. 2  
upper laterals & canines



**1005**  
Fig. 3  
upper incisors & canines



**1006**  
Fig. 4  
upper incisors & canines

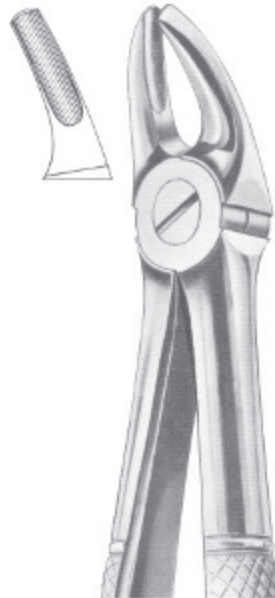

**1007**  
Fig. 7  
upper premolars

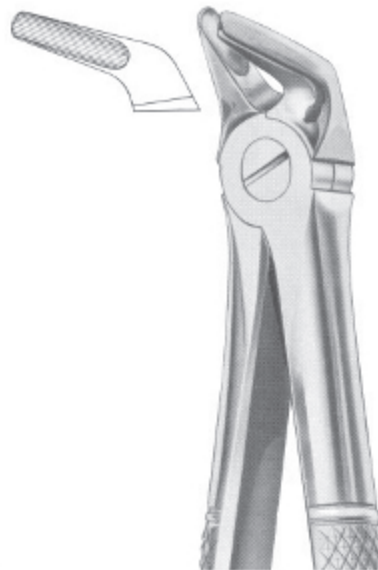

**1008**  
Fig. 8  
lower premolars



**1009**  
Fig. 13  
lower premolars

## Extraction Forceps "English Pattern"



**1010**  
Fig. 13S  
lower premolars  
for children.

**1011**  
Fig. 17  
upper molars, right

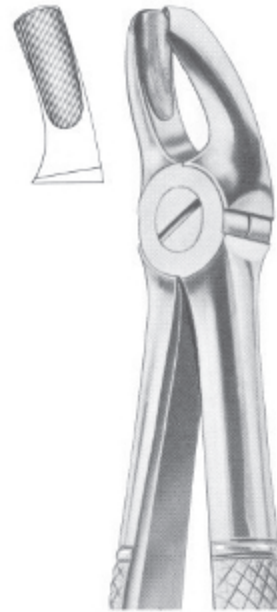

**1012**  
Fig. 18  
upper molars, left

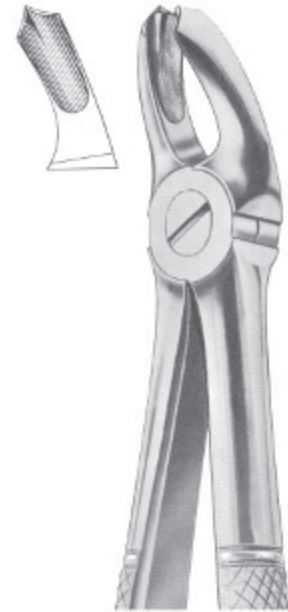

**1013**  
Fig. 18A  
upper molars

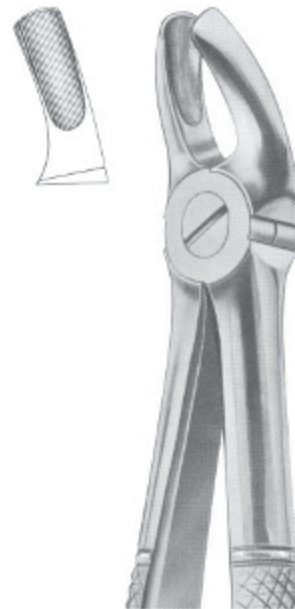

**1014**  
Fig. 18B  
upper molars



**1015**  
Fig. 19  
upper third molars



## Extraction Forceps "English Pattern"



**1016**  
Fig. 20  
upper third molars

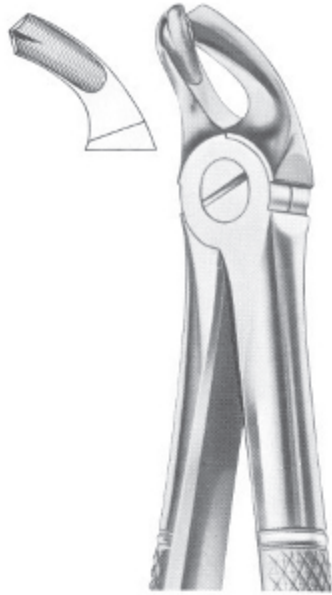

**1017**  
Fig. 21  
lower molars

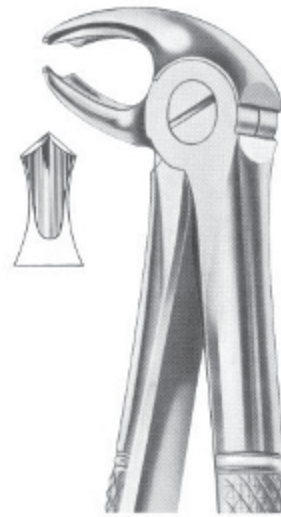

**1018**  
Fig. 22  
lower molars

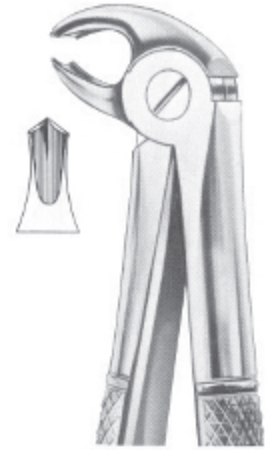

**1019**  
Fig. 22S  
lower molars  
for children

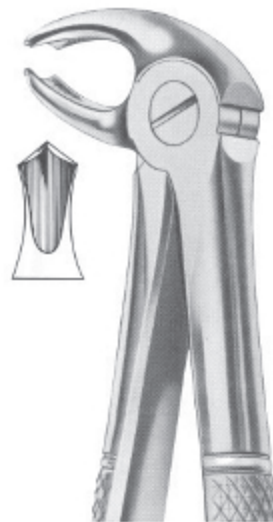

**1020**  
Fig. 22G  
lower molars



**1021**  
Fig. 23  
lower molars right

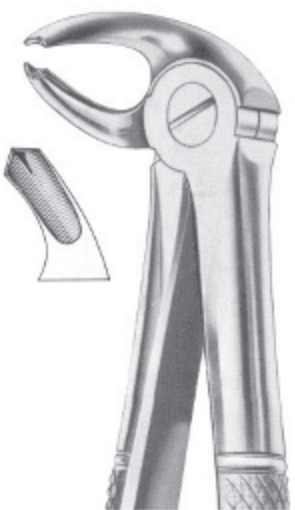

**1022**  
Fig. 24  
lower molars left

## Extraction Forceps "English Pattern"



**1023**  
Fig. 29  
upper roots



**1024**  
Fig. 29S  
upper roots for children



**1025**  
Fig. 30  
upper roots

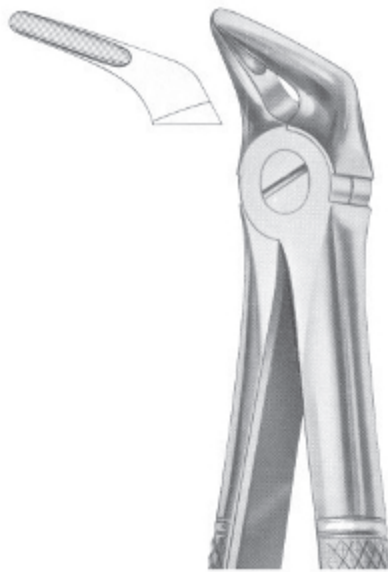

**1026**  
Fig. 31  
lower roots

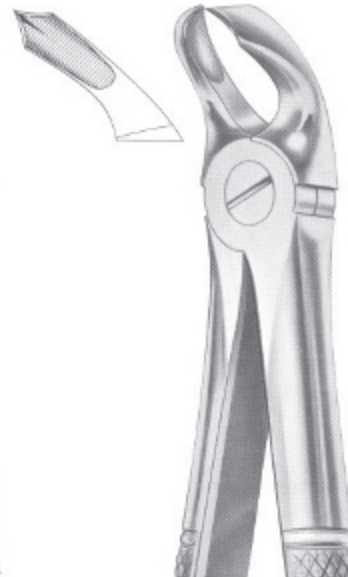

**1027**  
Fig. 32  
lower molars



**1028**  
Fig. 30S  
upper roots for children

## Extraction Forceps "English Pattern"



**1029**  
Fig. 33  
lower roots

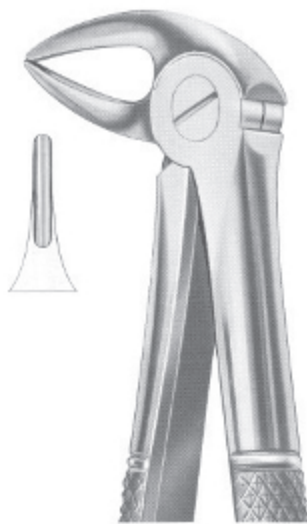

**1030**  
Fig. 33A  
lower roots



**1031**  
Fig. 33B  
lower roots

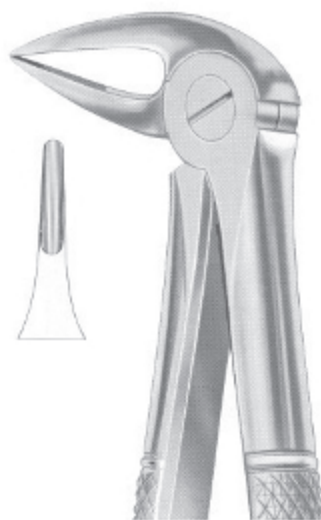

**1032**  
Fig. 33L  
lower roots



**1033**  
Fig. 37  
upper incisors  
for children



**1034**  
Fig. 33S  
lower roots  
for children

## Extraction Forceps "English Pattern"



**1035**  
Fig. 38  
lower incisors &  
canines for children

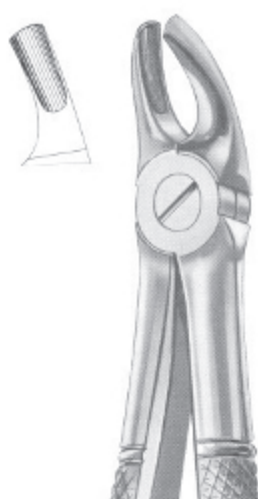

**1036**  
Fig. 39  
upper molars  
for children



**1037**  
Fig. 39R  
upper molars right  
for children



**1040**  
Fig. 39L  
upper molars left  
for children



**1038**  
Fig. 39A  
upper molars  
for children



**1039**  
Fig. 40  
lower molars  
for children

## Extraction Forceps "English Pattern"



**1041**  
Fig. 41  
upper roots

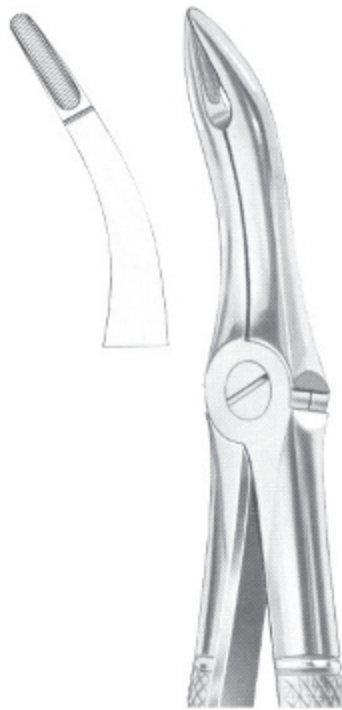

**1042**  
Fig. 44  
upper roots

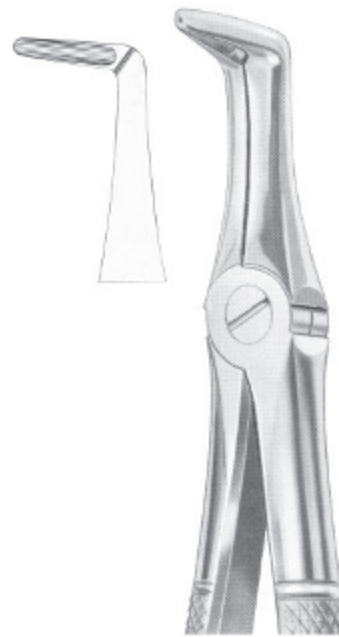

**1043**  
Fig. 45  
lower roots

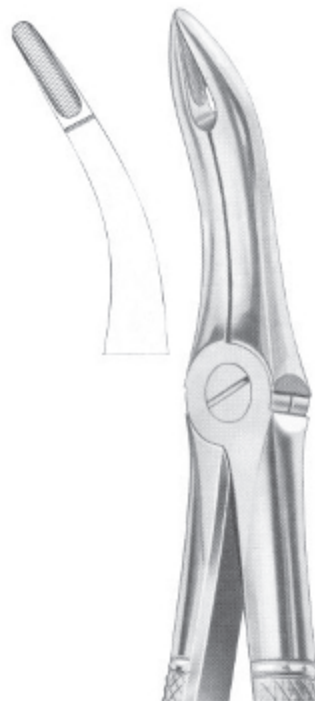

**1044**  
Fig. 48  
lower roots

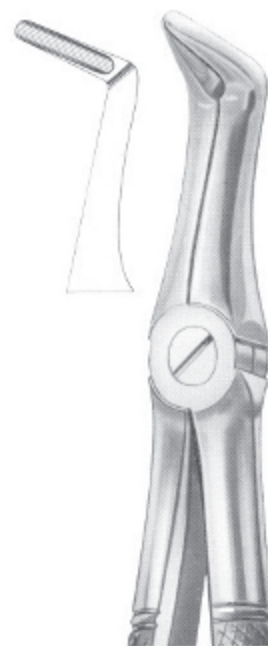

**1045**  
Fig. 49  
upper roots



**1046**  
Fig. 50  
upper roots

## Extraction Forceps "English Pattern"

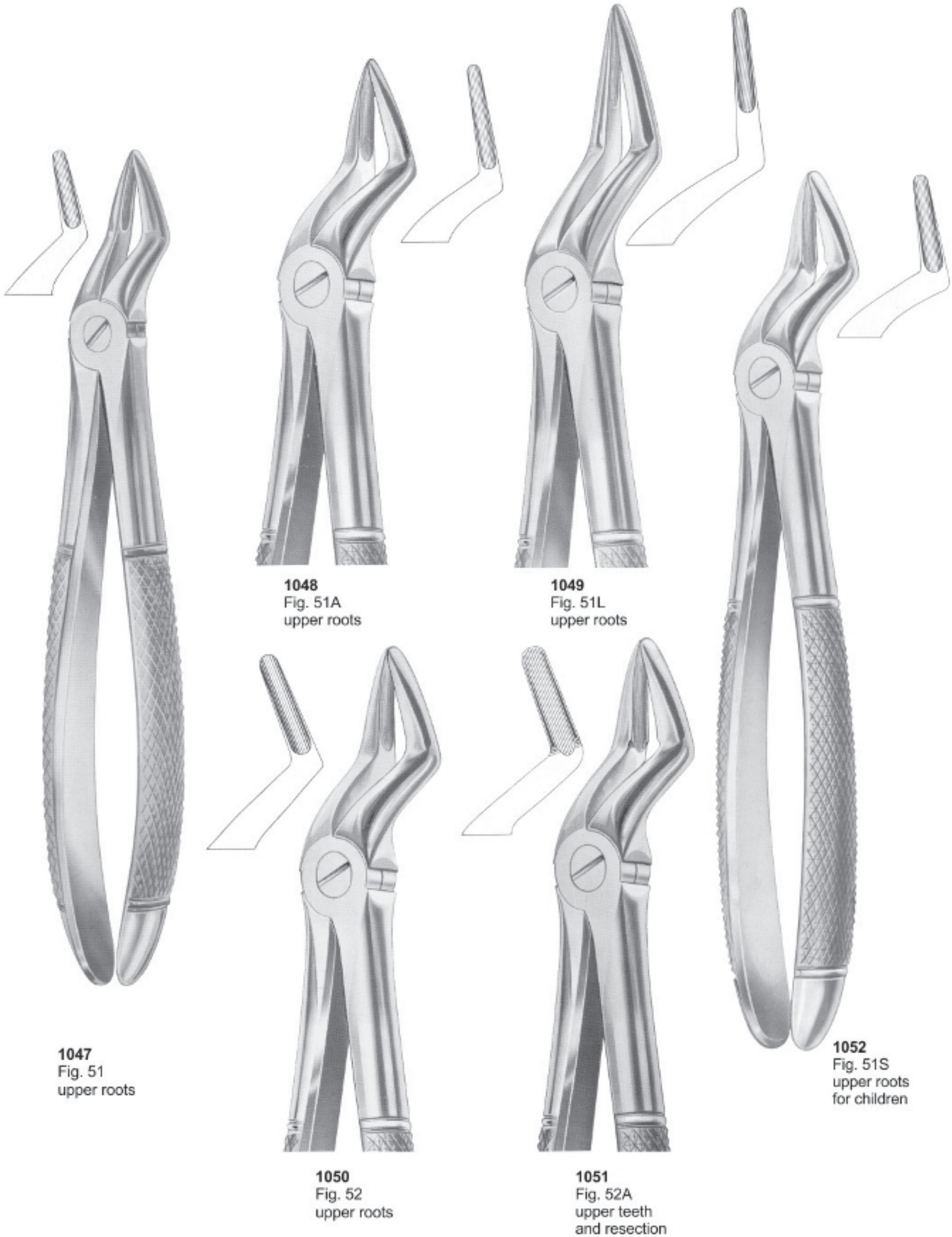

## Extraction Forceps "English Pattern"



**1053**  
Fig. 54  
for separating  
upper molars



**1054**  
Fig. 55  
for separating  
upper molars



**1055**  
Fig. 56  
for separating  
lower molars

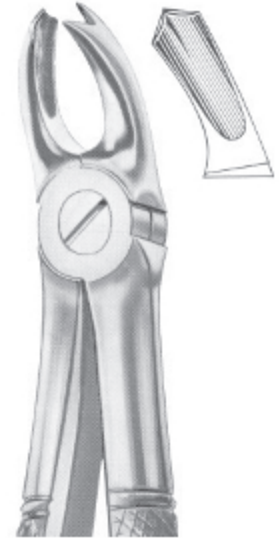

**1056**  
Fig. 65R  
upper molars  
right



**1057**  
Fig. 65L  
upper molars left



**1058**  
Fig. 67  
upper third molars

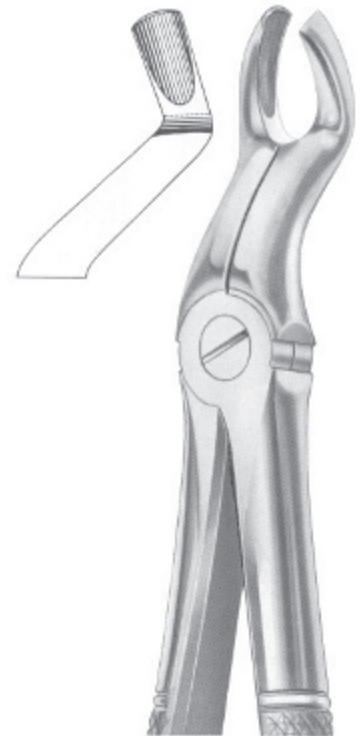

**1059**  
Fig. 67A  
upper third molars

## Extraction Forceps "English Pattern"



**1060**  
Fig. 67 ½R  
upper third molars  
right

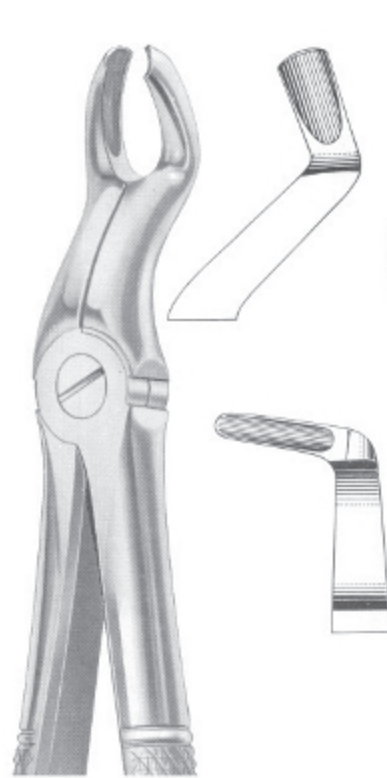

**1061**  
Fig. 67 ½L  
upper third molars  
left



**1062**  
Fig. 68  
lower roots

**1063**  
Fig. 68A  
lower roots



**1064**  
Fig. 73  
lower molars



**1065**  
Fig. 73R  
lower molars right



**1066**  
Fig. 73L  
lower molars left



## Extraction Forceps "English Pattern"



**1067**  
Fig. 73A  
lower molars



**1068**  
Fig. 73S  
lower molars



**1069**  
Fig. 73B  
lower molars for children



**1072**  
Fig. 73K  
lower molars  
for children



**1070**  
Fig. 74  
lower roots



**1071**  
Fig. 74D  
lower roots

## Extraction Forceps "English Pattern"



**1073**  
Fig. 74M  
lower roots



**1074**  
Fig. 74N  
lower roots



**1075**  
Fig. 74XN  
lower roots and  
crowded incisors



**1076**  
Fig. 75  
lower premolars



**1077**  
Fig. 76  
upper roots



**1078**  
Fig. 76N  
upper roots

## Extraction Forceps "English Pattern"



**1079**  
Fig. 76S  
upper roots



**1080**  
Fig. 79  
lower third molars



**1081**  
Fig. 79A  
lower third molars



**1082**  
Fig. 81  
lower premolars  
and roots

## Extraction Forceps "English Pattern"



**1083**  
Fig. 86A  
lower molars



**1084**  
Fig. 86B  
lower molars



**1085**  
Fig. 86C  
lower molars



**1086**  
Fig. 87  
lower molars



**1087**  
Fig. 91  
for separating  
lower molars



**1088**  
Fig. 99  
lower molars

**Extraction Forceps "English Pattern"**



**1089**  
Fig. 101  
upper premolars  
and roots

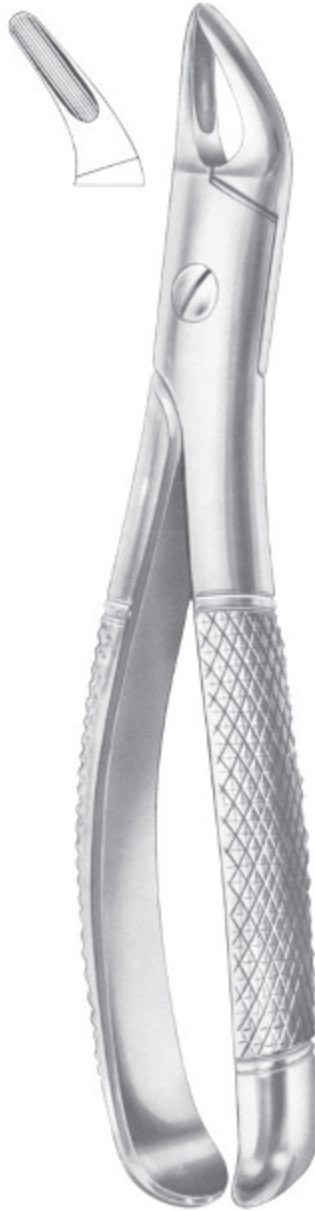

**1090**  
Fig. 100  
upper roots



**1091**  
Fig. 99 1/4  
lower molars



**1092**  
Fig. 99 1/2  
lower molars

## Extraction Forceps "English Pattern"



**1093**  
Fig. 102  
upper molars right



**1094**  
Fig. 103  
upper molars left



**1095**  
Fig. 105  
lower incisors



**1096**  
Fig. 106  
lower incisors



**1097**  
Fig. 103  
upper canines

## Extraction Forceps "English Pattern"



**1098**  
Fig. 112  
upper roots

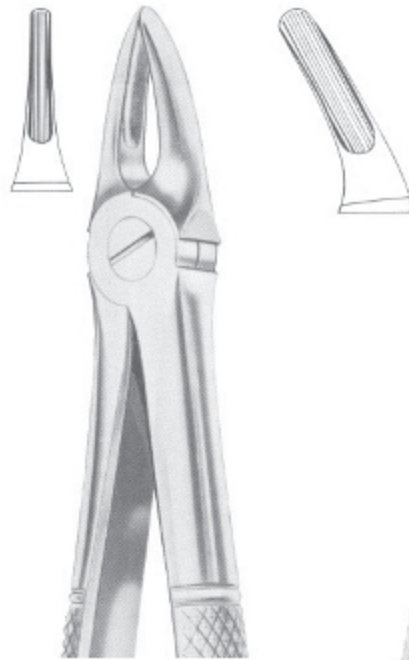

**1099**  
Fig. 113  
upper roots



**1101**  
Fig. 136  
upper premolars  
and roots



**1102**  
Fig. 137  
lower incisors  
and roots



**1100**  
Fig. 114  
upper roots



**1103**  
Fig. 143  
lower roots

## Extraction Forceps "English Pattern"

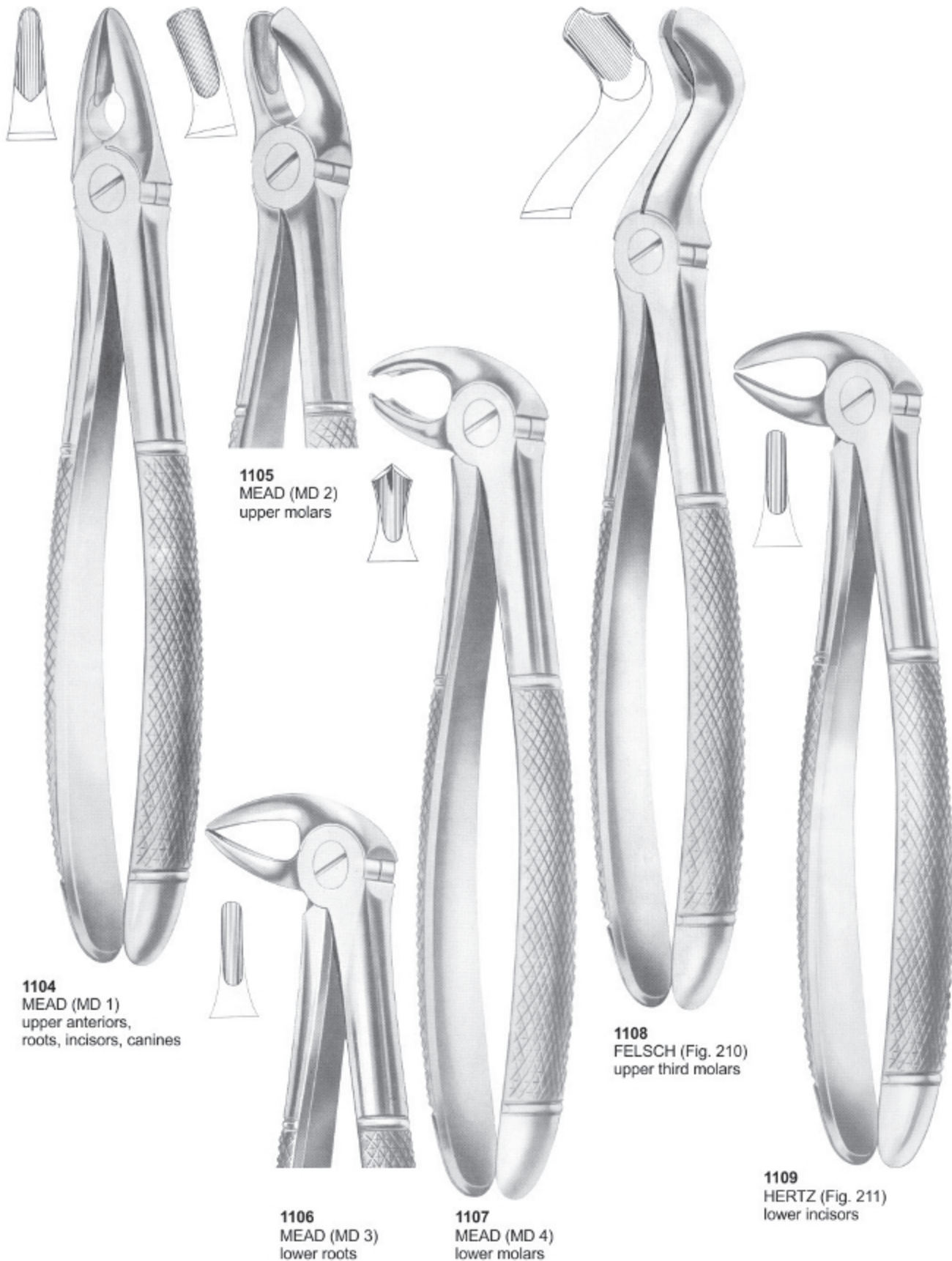



## Wisdom Extraction Forceps



**1110**  
ROUTURIER (Fig. 212)  
( 22 ½ L )  
lower molars  
and wisdom left



**1111**  
ROUTURIER (Fig. 213)  
( 22 ½ R )  
lower molars  
and wisdom right



**1112**  
ROUTURIER (Fig. 214)  
( 22 ½ L )  
lower molars  
and wisdom left



**1113**  
ROUTURIER (Fig. 215)  
( 33 ½ R )  
lower molars  
and wisdom right



**1114**  
RESECTION FORCEPS  
( 216/Witzel )  
upper roots

## Extraction Forceps "English Pattern"



1115  
Fig. 5



1116  
Fig. 6

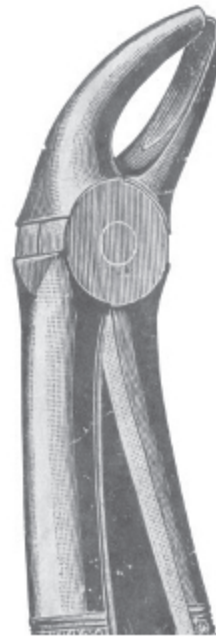

1117  
Fig. 9



1118  
Fig. 10



1119  
Fig. 11



1120  
Fig. 12



1121  
Fig. 14



1122  
Fig. 15

## Extraction Forceps "English Pattern"



1123  
Fig. 25



1124  
Fig. 26



1125  
Fig. 27

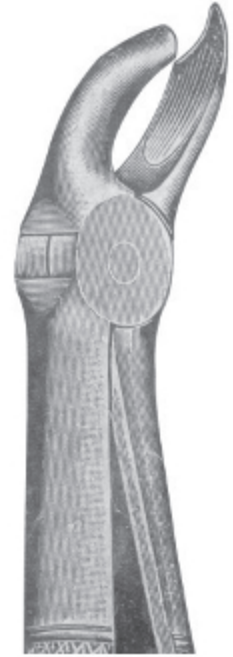

1126  
Fig. 28



1127  
Fig. 34



1128  
Fig. 35

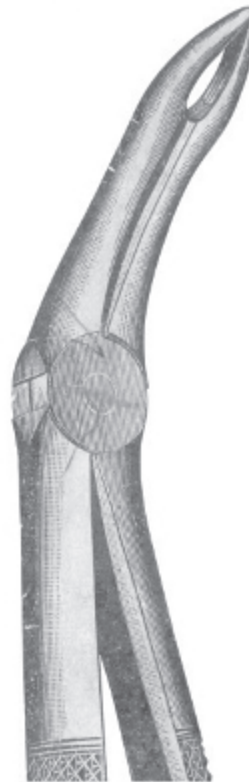

1129  
Fig. 42

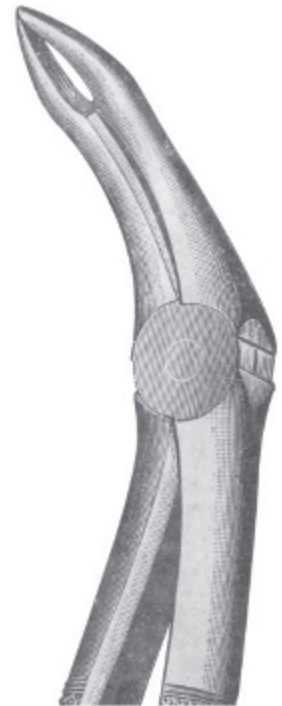

1130  
Fig. 43

## Extraction Forceps "English Pattern"



1131  
Fig. 44A



1132  
Fig. 46

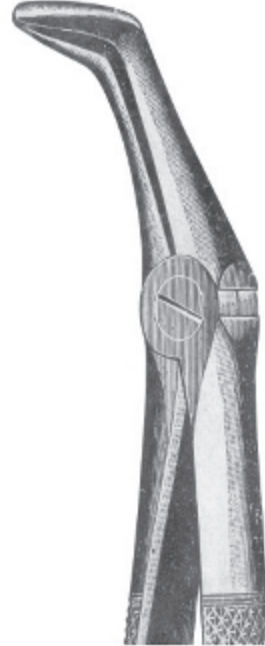

1133  
Fig. 47



1134  
Fig. 50A



1135  
Fig. 74R



1136  
Fig. 74L

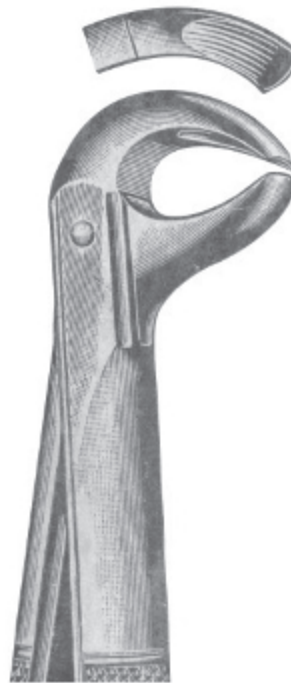

1137  
Fig. 75R



1138  
Fig. 75L

## Extraction Forceps "English Pattern"



**1139**  
Fig. 94



**1140**  
Fig. 95



**1141**  
Fig. 98



**1142**  
Fig. 105



**1143**  
Fig. 106



**1144**  
Fig. 2002

## Extraction Forceps "with fitting handle"



**1145**  
Fig. 1  
upper laterals  
and canines



**1146**  
Fig. 2  
upper laterals  
and canines



**1147**  
Fig. 3  
upper incisors  
and canines

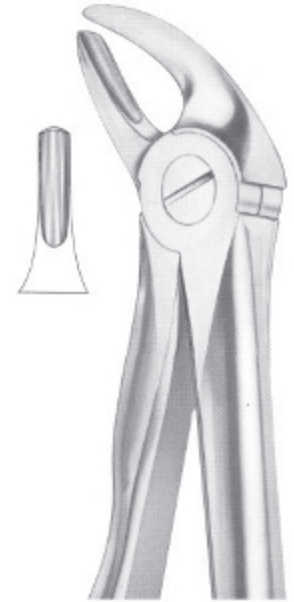

**1148**  
Fig. 4  
lower incisors  
and canines



**1149**  
Fig. 7  
upper premolars

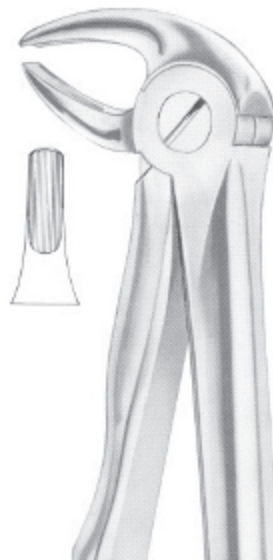

**1150**  
Fig. 13  
lower premolars



**1151**  
Fig. 13S  
lower premolars  
for children

## Extraction Forceps "with fitting handle"



**1152**  
Fig. 17  
upper molars right

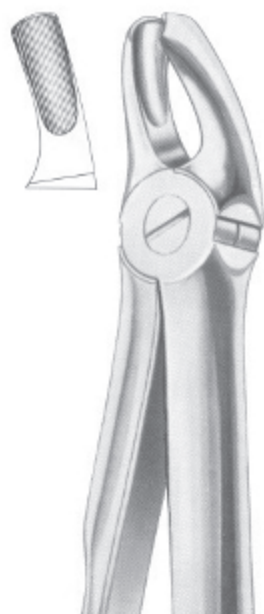

**1153**  
Fig. 18  
upper molars left

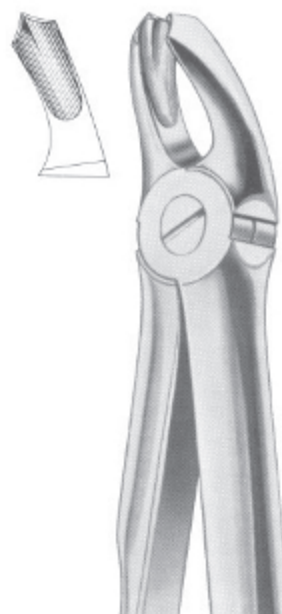

**1154**  
Fig. 18A  
upper molars

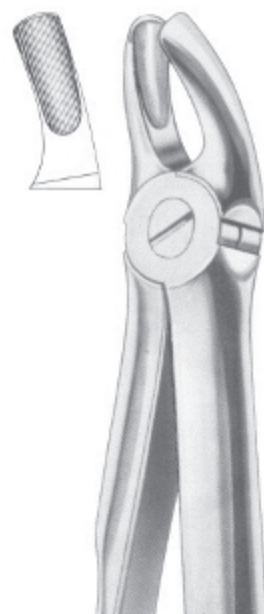

**1155**  
Fig. 18B  
upper molars



**1156**  
Fig. 19  
upper third molars

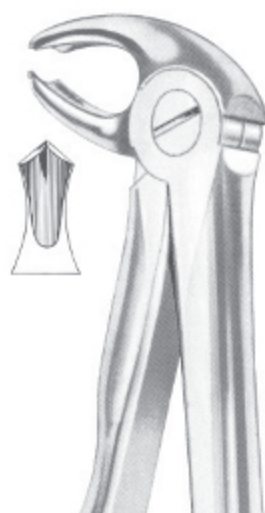

**1157**  
Fig. 22  
lower molars



**1158**  
Fig. 22S  
lower molars  
for children

## Extraction Forceps "with fitting handle"



**1159**  
Fig. 29  
upper roots



**1160**  
Fig. 29S  
upper roots  
for children

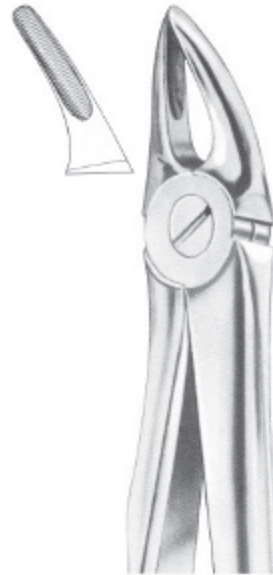

**1161**  
Fig. 30  
upper roots



**1162**  
Fig. 30S  
upper roots  
for children

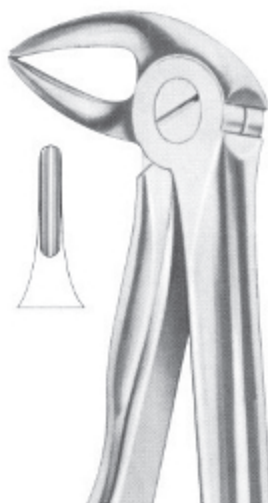

**1163**  
Fig. 33  
lower roots

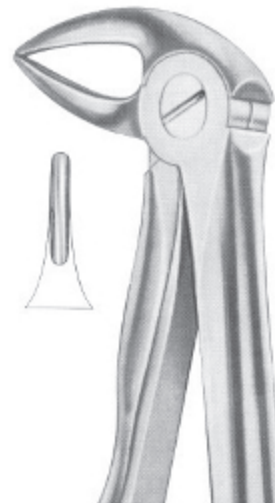

**1164**  
Fig. 33A  
lower roots

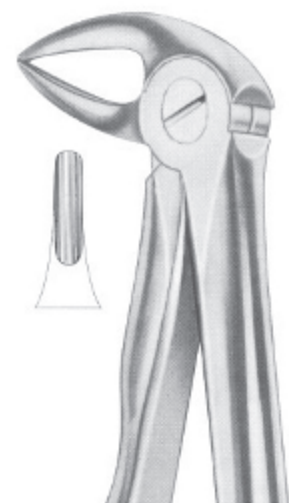

**1165**  
Fig. 33B  
lower roots



## Extraction Forceps "with fitting handle"



**1166**  
Fig. 33L  
lower roots



**1167**  
Fig. 33S  
lower roots  
for children



**1168**  
Fig. 37  
upper incisors  
for children



**1169**  
Fig. 39  
upper incisors  
for children



**1170**  
Fig. 39A  
upper molars  
for children



**1171**  
Fig. 39R  
upper molars right  
for children



**1172**  
Fig. 39L  
upper molars left  
for children

## Extraction Forceps "with fitting handle"



**1173**  
Fig. 41  
upper roots

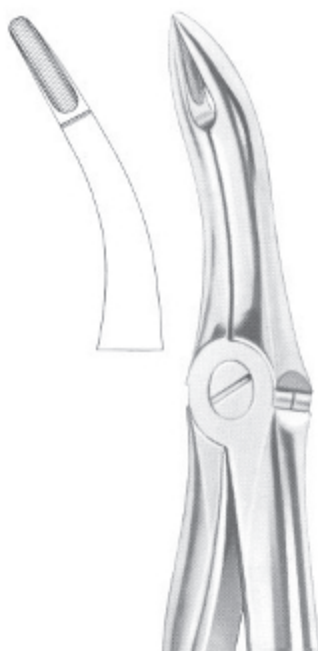

**1174**  
Fig. 44  
upper roots

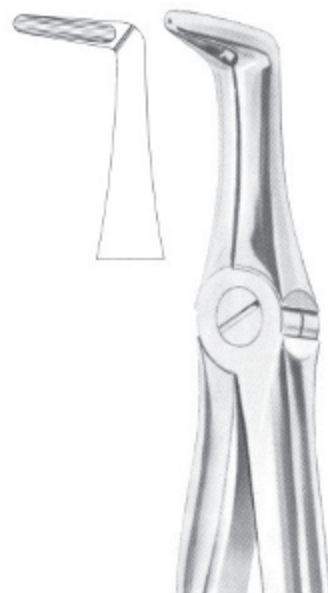

**1175**  
Fig. 45  
lower roots

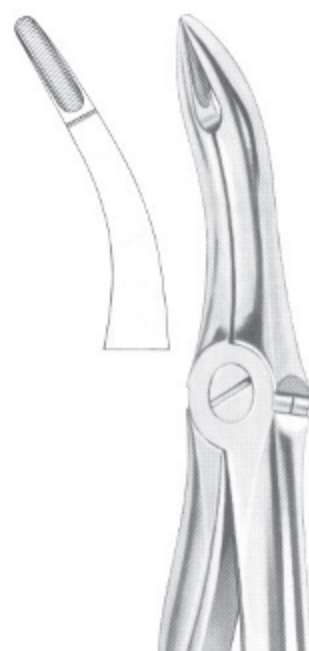

**1176**  
Fig. 48  
lower roots

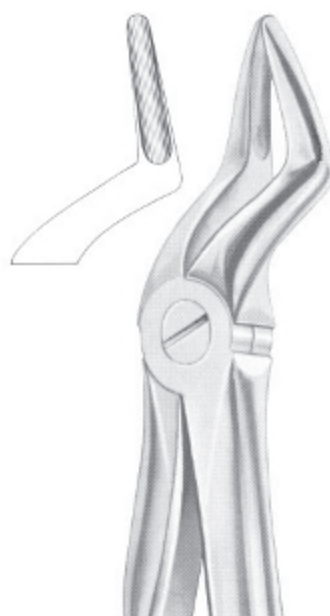

**1177**  
Fig. 51  
upper roots



**1178**  
Fig. 51A  
upper roots



**1179**  
Fig. 51S  
upper roots  
for children

**Extraction Forceps "with fitting handle"**



**1180**  
Fig. 51L  
upper roots

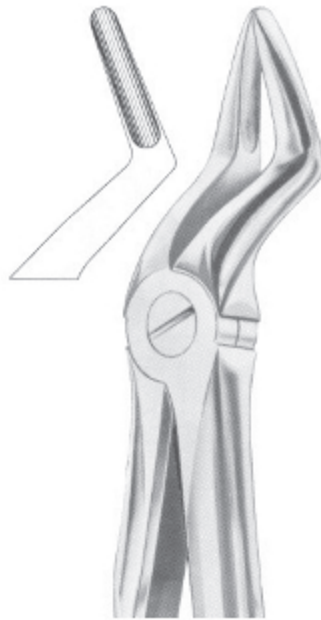

**1181**  
Fig. 52  
upper roots

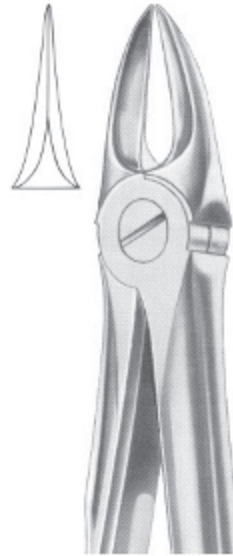

**1182**  
Fig. 54  
for separating  
upper molars



**1183**  
Fig. 65R  
upper molars right

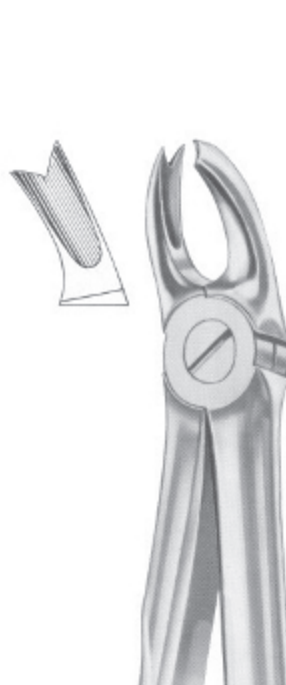

**1184**  
Fig. 65L  
upper molars left



**1185**  
Fig. 67  
upper third molars

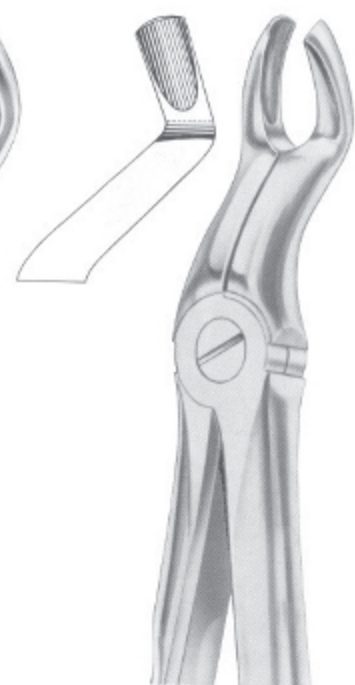

**1186**  
Fig. 67A  
upper third molars

**Extraction Forceps "with fitting handle"**



**1187**  
Fig. 67 ½ R  
upper third molars  
right

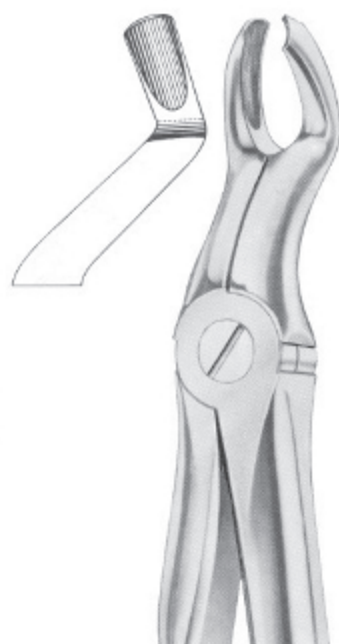

**1188**  
Fig. 67 ½ L  
upper third molars  
left



**1189**  
Fig. 73  
lower molars



**1190**  
Fig. 74  
lower roots



**1191**  
Fig. 74M  
lower roots



**1192**  
Fig. 74N  
lower roots



**1193**  
Fig. 74XN  
lower roots and  
crowded incisors

**Extraction Forceps "with fitting handle"**



**1194**  
Fig. 75  
lower premolars



**1195**  
Fig. 76  
upper roots



**1196**  
Fig. 76N  
upper roots



**1197**  
Fig. 81  
lower premolars  
and roots

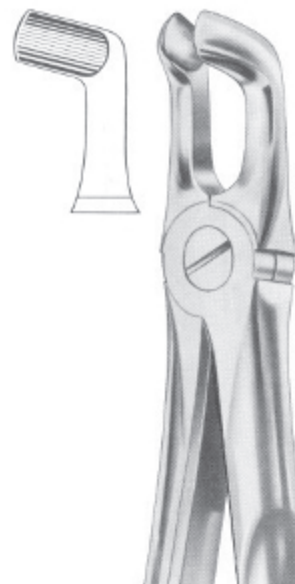

**1198**  
Fig. 76A  
lower third molars



**1199**  
Fig. 79  
lower third molars

**Extraction Forceps "with fitting handle"**



**1200**  
Fig. 86A  
lower molars



**1201**  
Fig. 86B  
lower molars



**1202**  
Fig. 86C  
lower molars



**1203**  
Fig. 99  
lower molars



**1204**  
Fig. 99 1/4  
lower molars

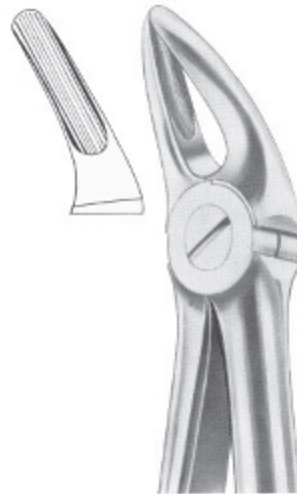

**1205**  
Fig. 136  
upper premolars  
and roots



**1206**  
Fig. 143  
lower roots

## Extraction Forceps "for children"



**1207**  
KLEIN (Fig. 217)  
upper incisors



**1208**  
KLEIN (Fig. 218)  
upper premolars



**1209**  
KLEIN (Fig. 219)  
upper roots



**1210**  
KLEIN (Fig. 220)  
upper molars



**1214**  
ALBRECHT  
Fig. 224  
Deciduous

**1215**  
ALBRECHT  
Fig. 225  
Deciduous



**1211**  
KLEIN (Fig. 221)  
lower incisors



**1212**  
KLEIN (Fig. 222)  
lower molars



**1213**  
KLEIN (Fig. 223)  
lower roots

## Root Splinter Forceps

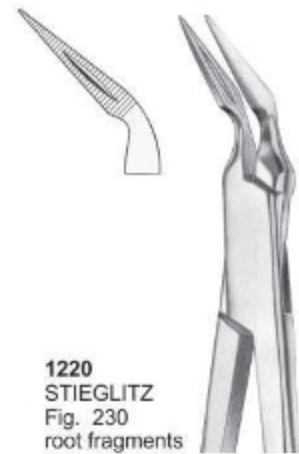
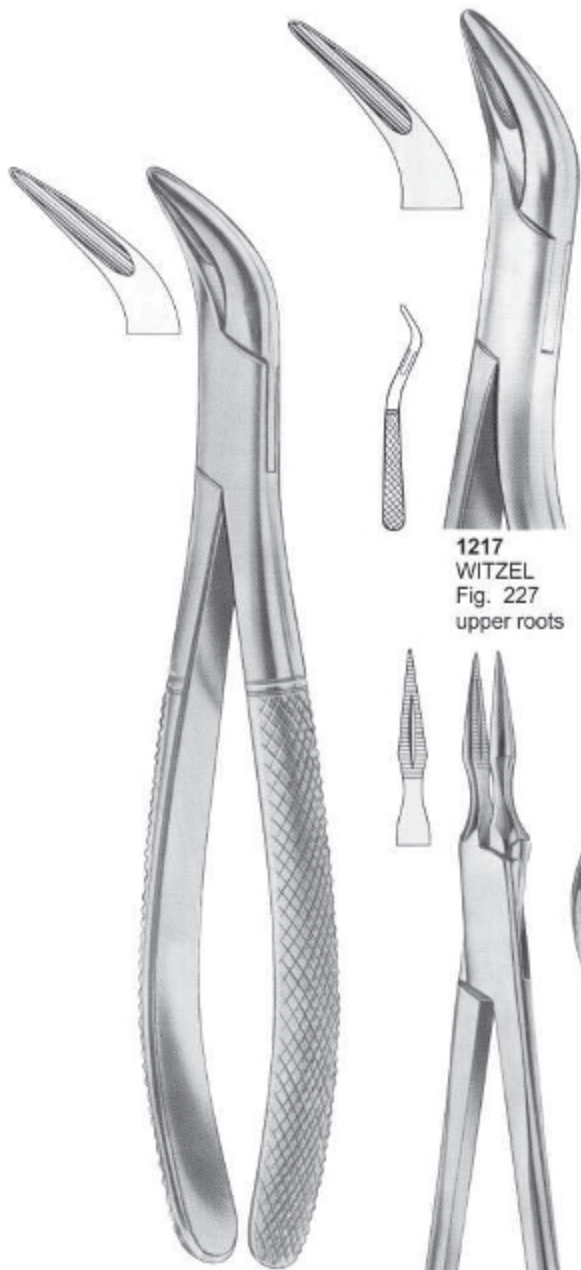



## Extraction Forceps "American Pattern"



**1222**  
W1-WINTER  
upper centrals  
and canines



**1223**  
Fig. 1  
upper incisors and roots

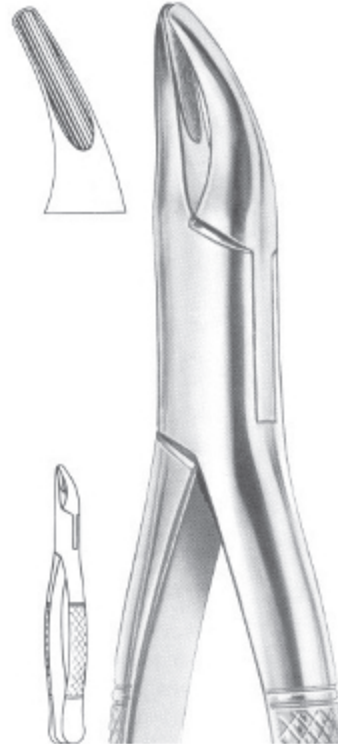

**1224**  
Fig. 2  
upper and lower roots



**1225**  
Fig. 4  
upper and lower premolars

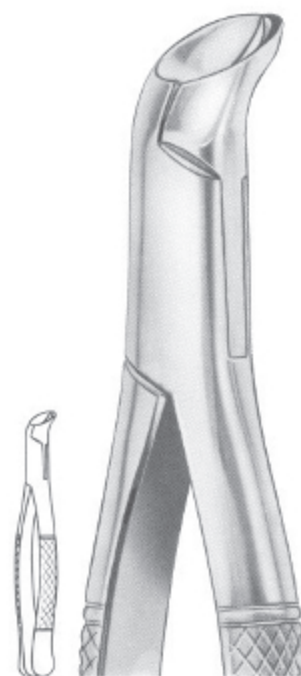

**1226**  
PHYSICK  
Fig. 5  
lower third molars



**1227**  
Fig. 6  
separating  
forceps

## Extraction Forceps "American Pattern"



**1228**  
Fig. 7  
upper roots

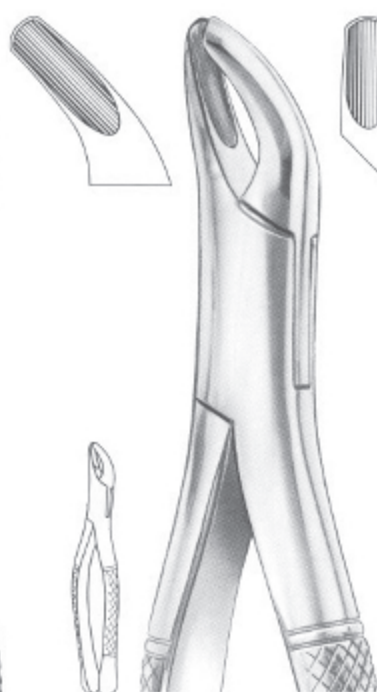

**1229**  
Fig. 8  
upper and lower  
third molars



**1231**  
Fig. 10H  
upper molars



**1232**  
Fig. 13  
upper incisors

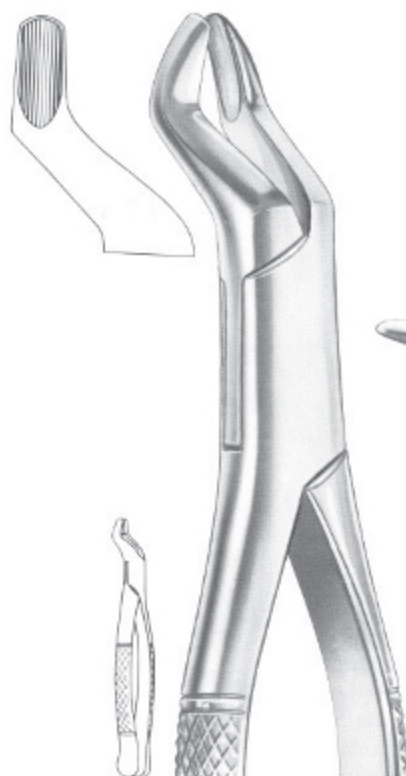

**1230**  
Fig. 10S  
upper molars



**1233**  
Fig. 14  
lower incisors

## Extraction Forceps "American Pattern"

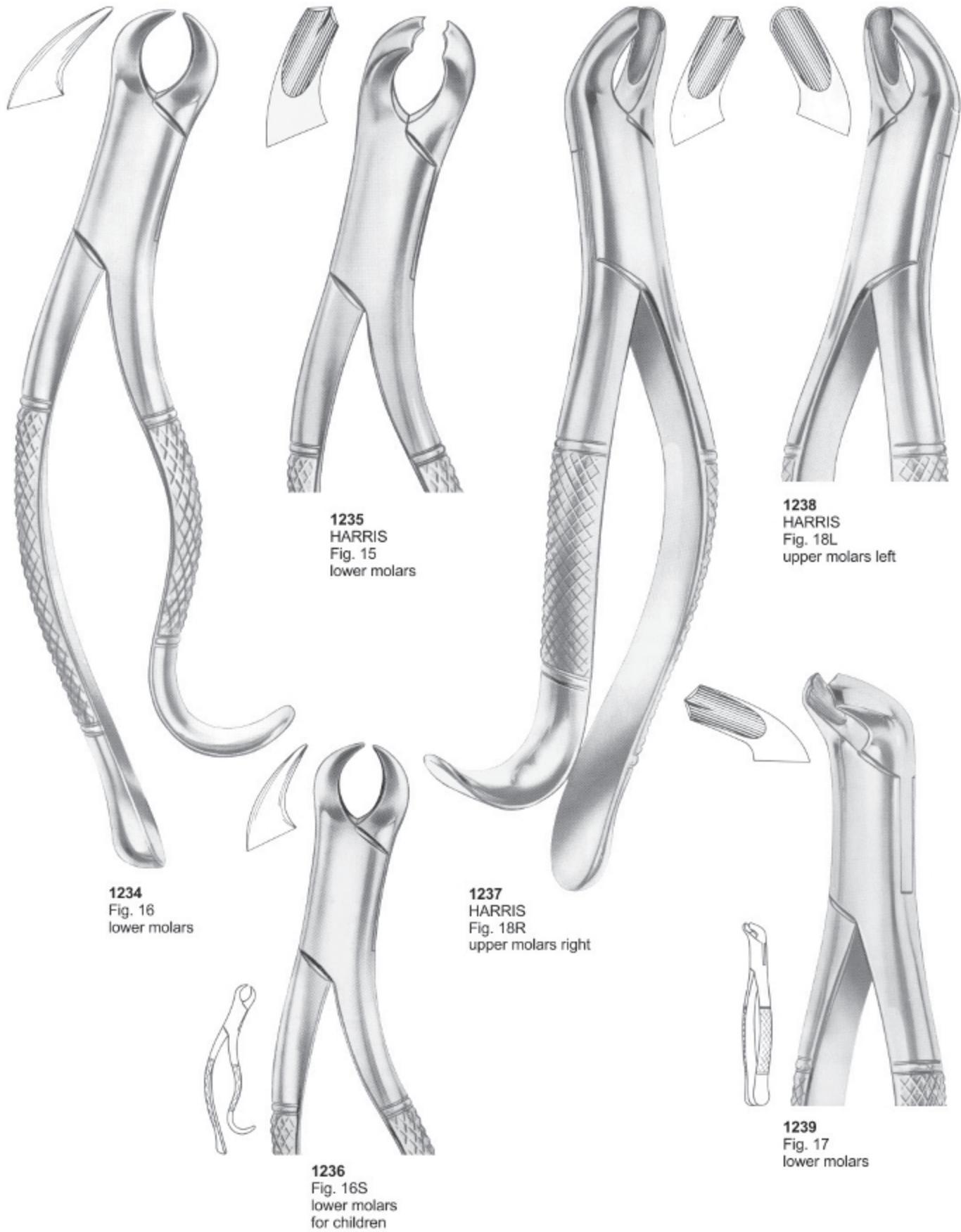

## Extraction Forceps "American Pattern"

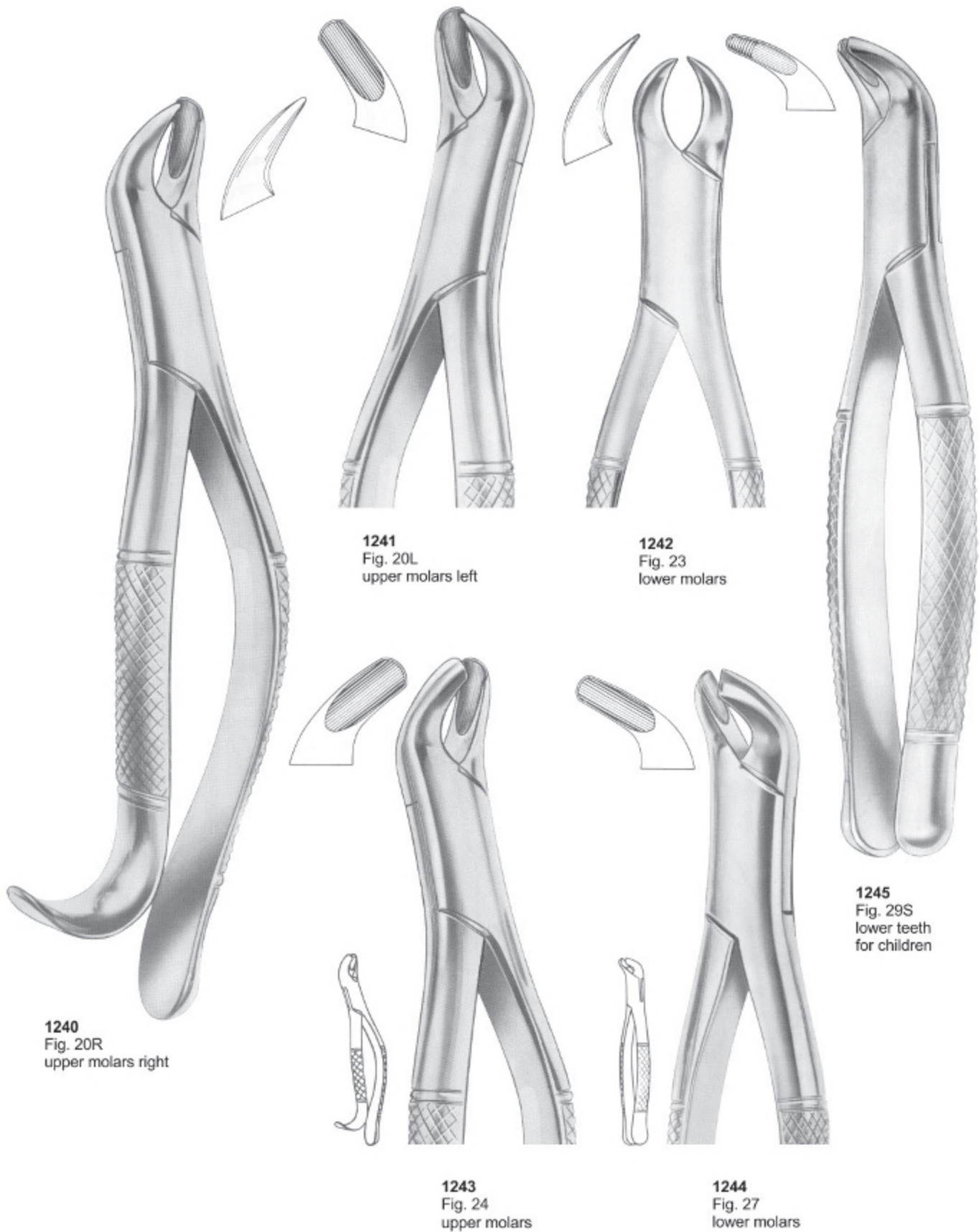

## Extraction Forceps "American Pattern"



**1246**  
Fig. 30S  
upper teeth  
for children



**1247**  
PARMLY  
Fig. 32  
upper premolars  
and molars



**1248**  
PARMLY  
Fig. 32A  
upper premolars  
and roots



**1249**  
Fig. 34  
lower anteriors  
and roots

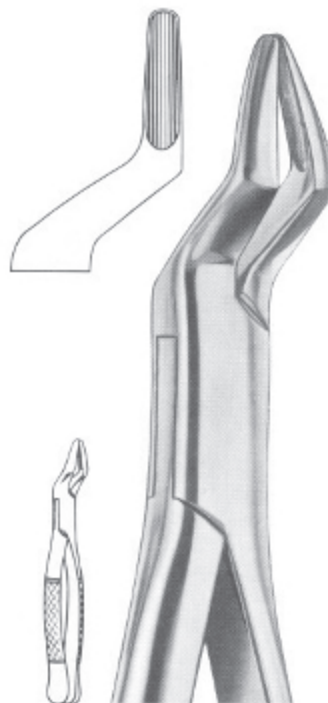

**1250**  
Fig. 35  
upper roots

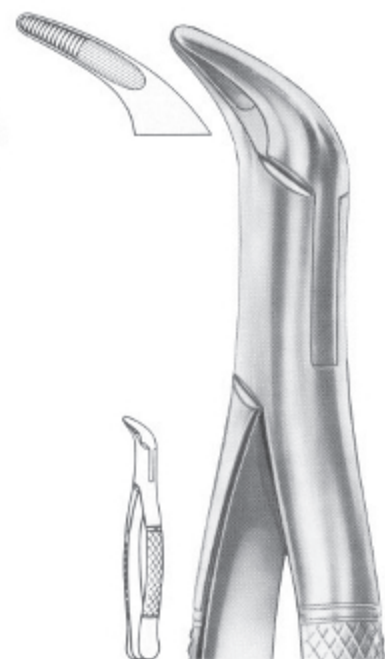

**1251**  
Fig. 36  
lower anteriors  
and roots

## Extraction Forceps "American Pattern"



**1252**  
Fig. 37  
lower anteriors  
and roots



**1254**  
Fig. 53R  
upper molars right



**1255**  
Fig. 53L  
upper molars left



**1257**  
Fig. 65  
upper incisors  
and roots

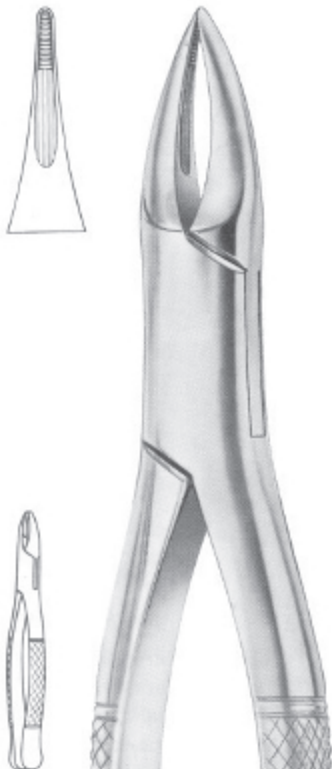

**1253**  
Fig. 38  
upper anteriors  
and roots

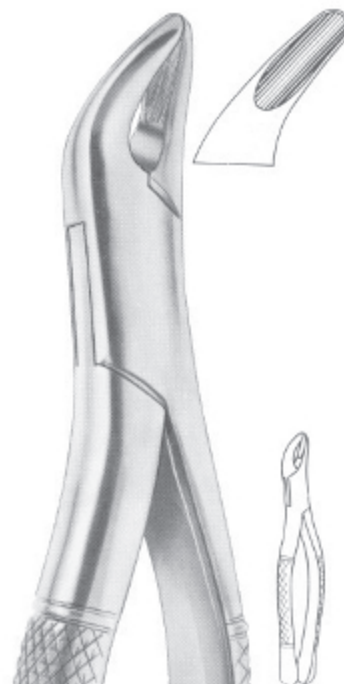

**1256**  
Fig. 62  
incisors, premolars,  
deciduous teeth

## Extraction Forceps "American Pattern"



**1258**  
TOMES  
Fig. 69  
upper and lower roots



**1259**  
TOMES  
Fig. 85  
lower canines,  
premolars and molars



**1260**  
NEVIUS  
Fig. 88R  
upper molars right



**1261**  
THOMAS  
Fig. 85A  
lower canines,  
premolars and molars



**1262**  
NEVIUS  
Fig. 88L  
upper molars left

## Extraction Forceps "American Pattern"

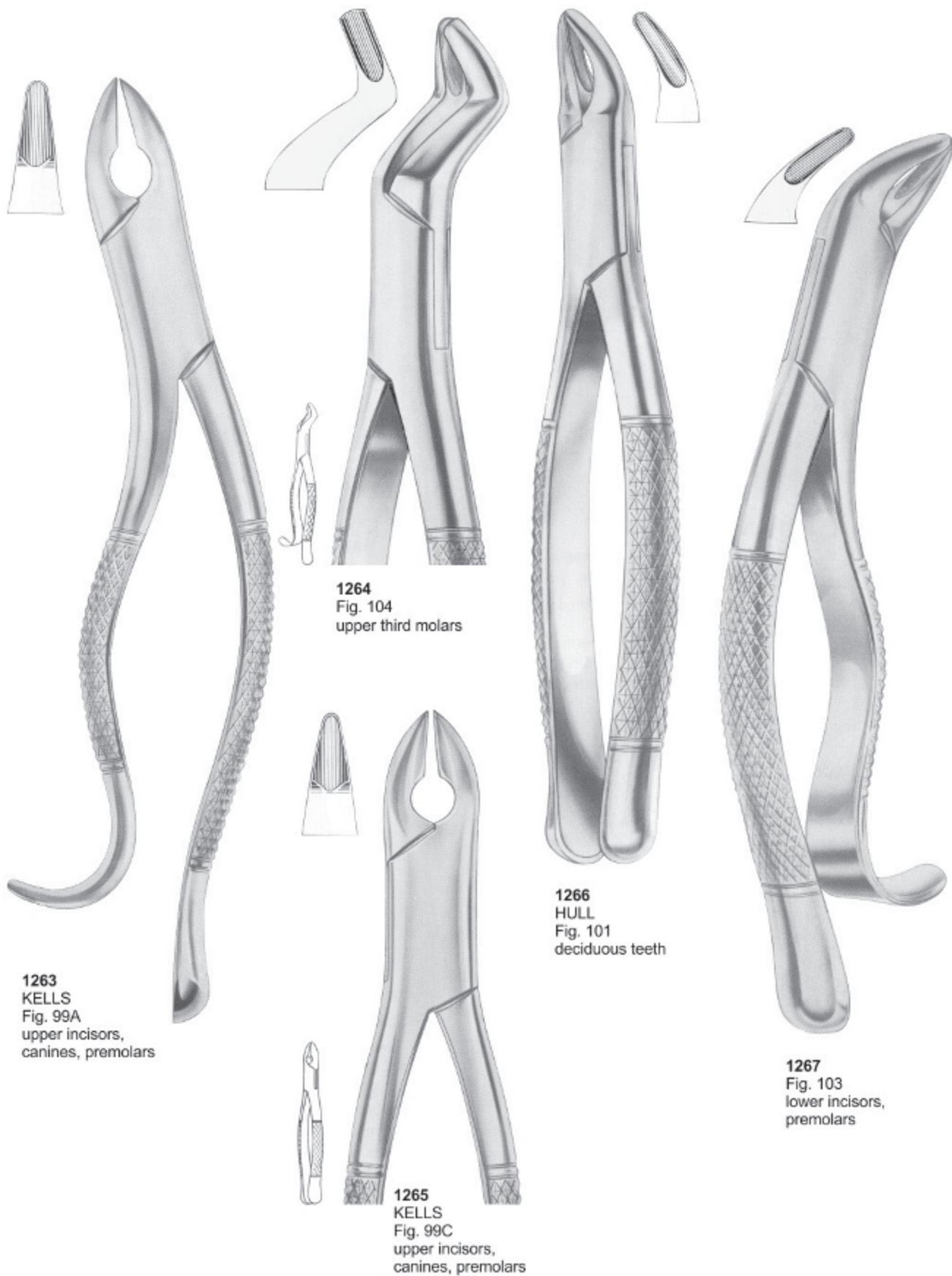



## Extraction Forceps "American Pattern"



**1268**  
CRYER  
Fig. 150  
lower incisors,  
premolars, roots



**1269**  
CRYER  
Fig. 150A  
upper incisors,  
premolars, roots



**1271**  
CRYER  
Fig. 151  
lower incisors,  
premolars, roots



**1272**  
CRYER  
Fig. 151A  
lower incisors,  
premolars, roots

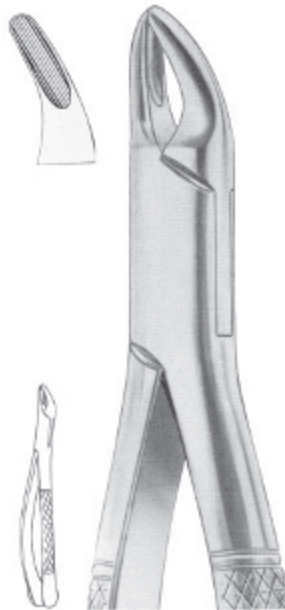

**1270**  
CRYER  
Fig. 150S  
upper teeth for children



**1273**  
CRYER  
Fig. 151S  
lower teeth  
for children

## Extraction Forceps "American Pattern"



**1274**  
Fig. 203  
lower incisors  
and roots

**1275**  
Fig. 210S  
upper third molars



**1276**  
Fig. 201  
upper incisors,  
canines, premolars



**1277**  
Fig. 210H  
upper third molars



**1278**  
Fig. 213  
upper centrals and canines

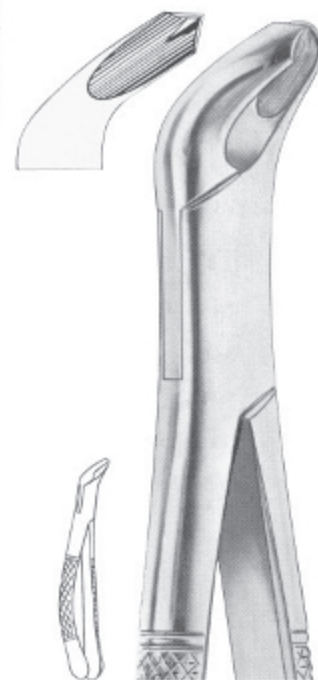

**1279**  
Fig. 217  
lower molars

## Extraction Forceps "American Pattern"

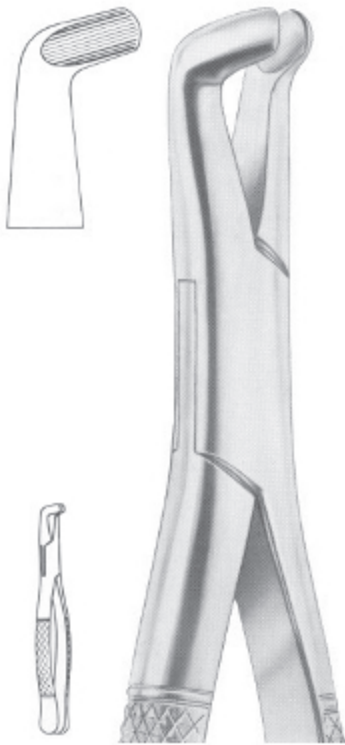

**1280**  
Fig. 222  
lower third molars



**1282**  
Fig. 286  
Swing lower molars



**1283**  
Fig. 288  
lower canines  
and premolars

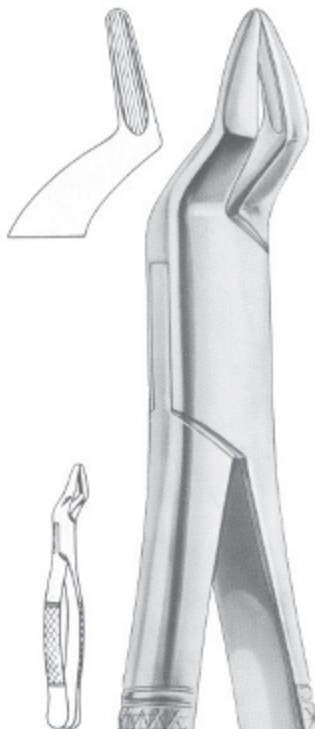

**1281**  
Fig. 286  
upper incisors and roots

## Extraction Forceps "American Pattern"

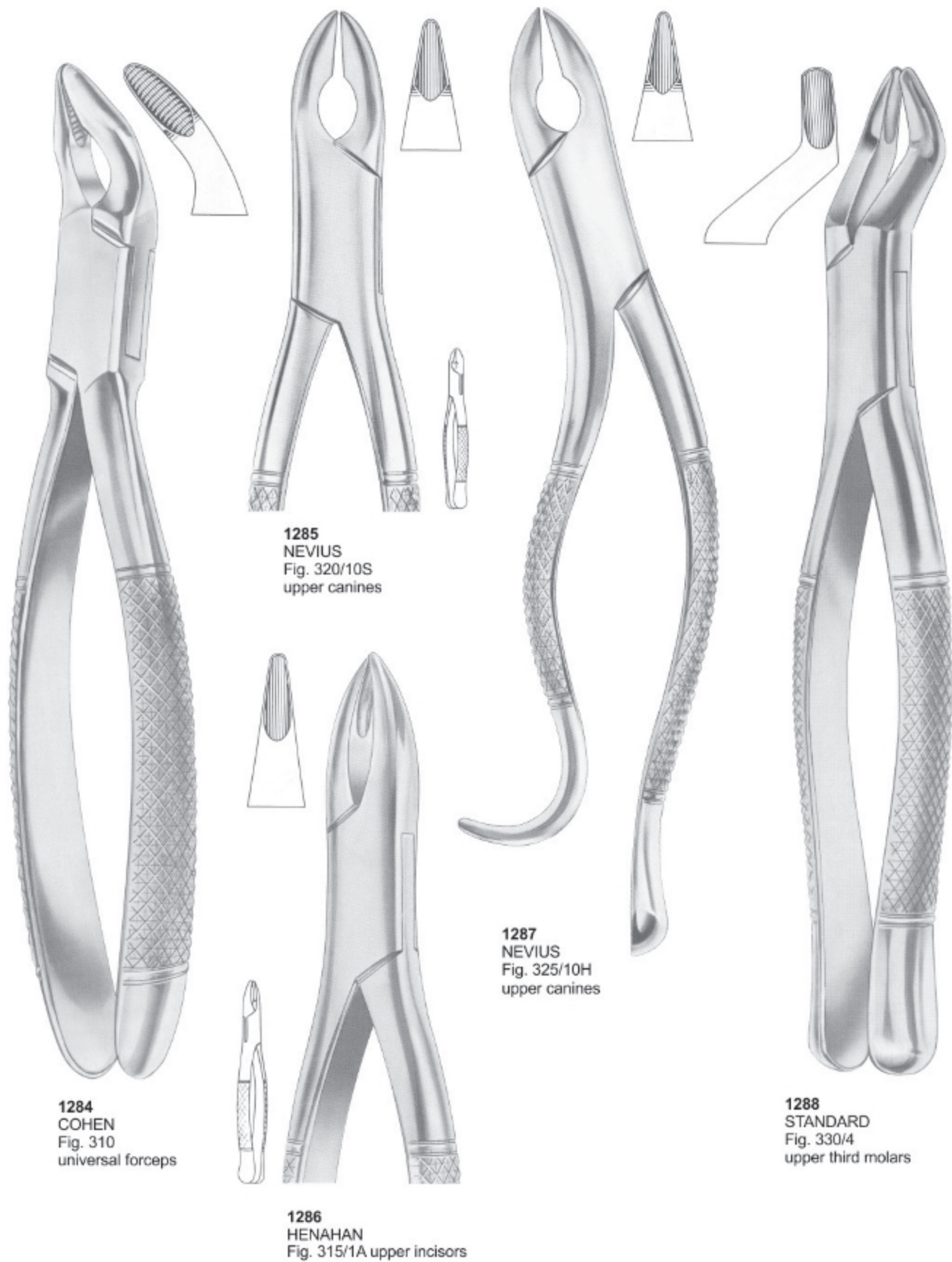

## Extraction Forceps "American Pattern"



**1289**  
WOODWARD  
Fig. 335/FH  
lower molars



**1290**  
Fig. 340/89  
upper molars right



**1292**  
Fig. 345/90  
upper molars left

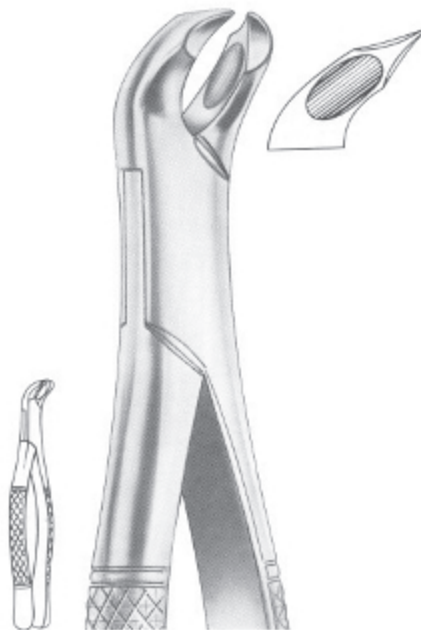

**1291**  
WOODWARD  
Fig. 335/FS  
lower molars

**Forceps for Children "American Pattern"**



**1293**  
Fig. 350/23S  
lower molars

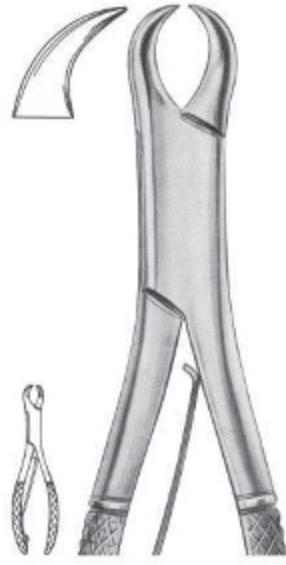

**1294**  
Fig. 355/23SK  
lower molars



**1295**  
Forcep Fig. 301



**1295-A**  
Forcep Fig. 300



**1296**  
Fig. 360/17SK  
lower molars



**1297**  
Fig. 365/150SK  
upper anteriors  
and roots



**1298**  
Fig. 370/151SK  
lower anteriors  
and roots

## Periosteal Elevators



1299  
Molt 9



1300  
Allen 9A



1301  
Prichard



1302  
Seldin



1303  
Goldman- Fox 14



1304  
West  
Dell W2

**Elevators**

Heidbrink Root - Tip Picks

Root Tip



**1305**  
DEL 78



**1306**  
DEL 79



**1307**  
DEL 80



**1308**  
DEL H1



**1309**  
DEL H2



**1310**  
DEL H3



**1311**  
DEL H2-3



**1312**  
POTT  
6X



**1313**  
POTT  
7X



## Periosteal Elevators



1314  
BUSER



1315  
OHI 10



1316  
HOWARD 9H



1317  
FREER



1318  
FREER 15



1319  
FREER 16

## Root Elevators

lower jaw, left side

lower jaw, right side



**1320**  
BEIN  
Fig. 4



**1331**



**1332**

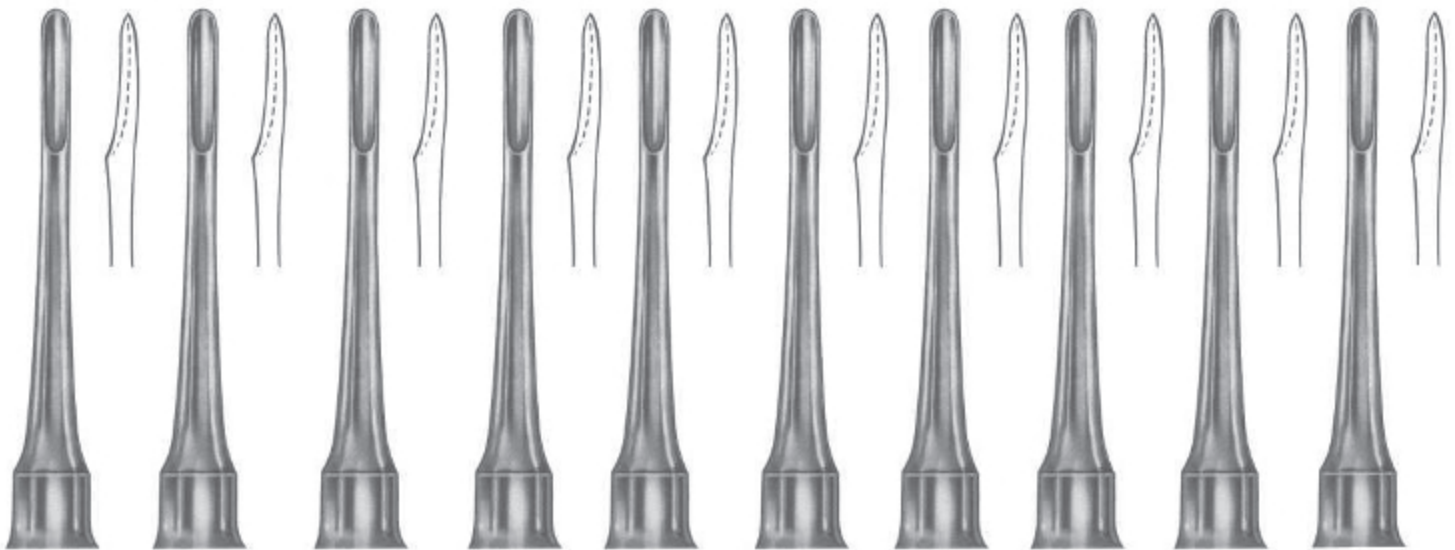

**1321**  
BEIN  
1.0 mm

**1322**  
BEIN  
1.5 mm

**1323**  
BEIN  
2.0 mm

**1324**  
BEIN  
2.5 mm

**1325**  
BEIN  
3.0 mm

**1326**  
BEIN  
3.5 mm

**1327**  
BEIN  
4.0 mm

**1328**  
BEIN  
4.5 mm

**1329**  
BEIN  
5.0 mm

**1330**  
BEIN  
5.5 mm

## Root Elevators



1333  
BEIN



1334  
BEIN  
Fig. 1



1335  
BEIN  
Fig. 2



1336  
BEIN  
Fig. 0



1337  
BEIN  
Fig. 3



1338  
BEIN  
Fig. 4



1339  
BEIN  
Fig. 5



1340  
BEIN  
Fig. 6

## Root Elevators



**1341**  
CRYER  
Fig. 3



**1342**  
CRYER  
Fig. 4



**1343**  
CRYER  
Fig. 12



**1344**  
CRYER  
Fig. 27



**1345**  
CRYER  
Fig. 28



**1346**  
CRYER  
Fig. 27S



**1347**  
CRYER  
Fig. 28S



**1348**  
SELDIN  
Fig. 2



**1349**  
SELDIN  
Fig. 3



**1350**  
SELDIN  
Fig. 4L



**1351**  
SELDIN  
Fig. 4R



**1352**  
SELDIN  
Fig. 1L



**1353**  
SELDIN  
Fig. 1R

## Elevators & Root Screws



1354



1355



1356



1357



1358



1359



1360

## Root Screws



1362  
Morrison  
2.0 mm



1363  
Morrison  
2.5 mm



1364  
Morrison  
3.0 mm



1361  
Morrison  
3.5 mm

## Root Elevators



**1365**  
IS-APICAL



**1366**  
APICAL  
2 mm  
Fig. 1



**1367**  
APICAL  
3 mm  
Fig. 2



**1368**  
APICAL  
4 mm  
Fig. 3



**1369**  
APICAL  
4.5 mm  
Fig. 4



**1370**  
APICAL  
2 mm  
Fig. 5



**1371**  
APICAL  
3 mm  
Fig. 6



**1372**  
APICAL  
4 mm  
Fig. 7



**1373**  
APICAL  
4.5 mm  
Fig. 8



**1374**  
APICAL  
Fig. 9



**1375**  
WINTER  
Fig. 14 L



**1376**  
WINTER  
Fig. 14 R



**1377**  
HEIDBRINK  
Fig. 1



**1378**  
HEIDBRINK  
Fig. 2



**1379**  
FLOHR  
Fig. 1



**1380**  
FLOHR  
Fig. 2



**1381**  
APICAL  
Fig. 1



**1382**  
APICAL  
Fig. 2

## Root Elevators



**1383**  
**IS-CRYER**



**1384**  
**CRYER**  
Fig. 1



**1385**  
**CRYER**  
Fig. 2



**1386**  
**IS-COUPLAND**



**1387**  
**COUPLAND**  
Fig. 1



**1388**  
**COUPLAND**  
Fig. 2



**1389**  
**COUPLAND**  
Fig. 3

## Root Elevators



**1390**  
Fig. 1



**1391**  
Fig. 2



**1392**  
Fig. 3



**1393**  
FLOHR  
Fig. 1

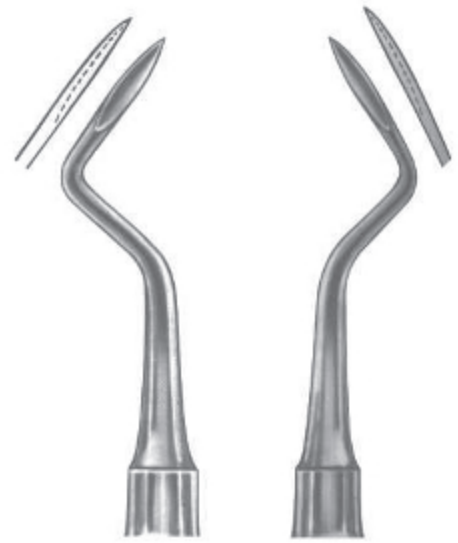

**1394**  
FLOHR  
Fig. 2

**1395**  
FLOHR  
Fig. 3



## Root Elevators



**1396**  
KOPP  
Fig. 1



**1397**  
KOPP  
Fig. 2



**1403**  
KOPP  
Fig. 1



**1404**  
KOPP  
Fig. 2



**1396**  
KOPP



**1398**  
KOPP  
Fig. 3



**1399**  
KOPP  
Fig. 4



**1402**  
KOPP



**1405**  
KOPP  
Fig. 3



**1406**  
KOPP  
Fig. 4



**1400**  
KOPP  
Fig. 5



**1401**  
KOPP  
Fig. 6

## Root Elevators



## Root Elevators



**1413**  
WARWICK-JAMES  
Fig. 1



**1413**  
Warwick-James  
Fig. 2



**1414**  
Warwick-James  
Fig. 3



**1415**  
London-Hospital  
Fig. 1



**1415**  
London-Hospital  
Fig. 2



**1416**  
London-Hospital  
Fig. 3

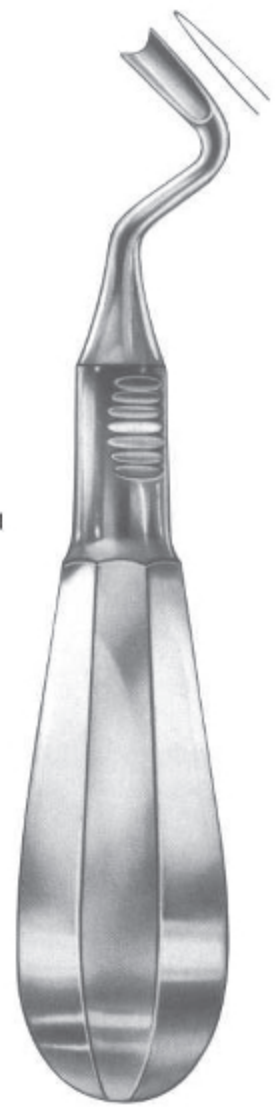

**1417**  
OTT

## Root Elevators



**1418**  
CHOMPRET  
Fig. 1



**1419**  
CHOMPRET  
Fig. 2



**1420**  
CHOMPRET  
Fig. 3



**1421**  
CHOMPRET  
Fig. 4



**1423**  
Fig. 1



**1422**  
Fig. 2

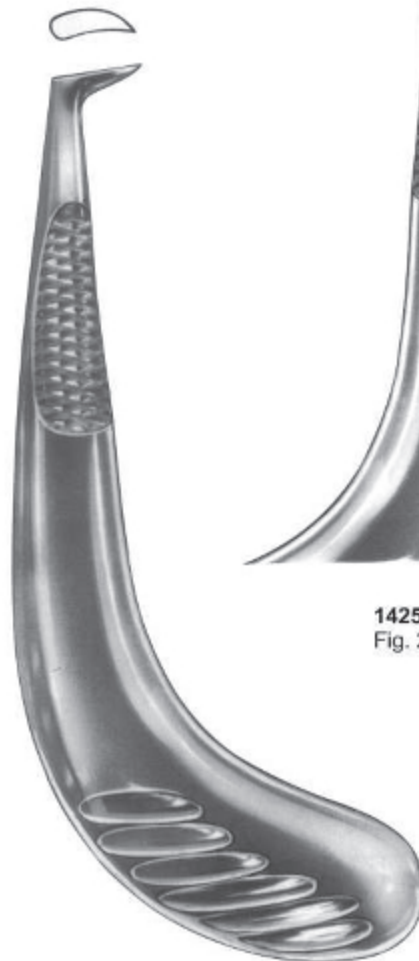

**1424**  
Fig. 1



**1425**  
Fig. 2



**1426**  
APICAL

## Root Tip Elevators



1427  
IS-Fig. 1



1428  
Fig. 2



1429  
Fig. 3



1430  
HEIDBRINK  
Fig. 1



1431  
HEIDBRINK  
Fig. 2



1432  
HEIDBRINK  
Fig. 3



1438  
MEAD  
MD1



1433  
LECLUSE



1434  
MEAD  
MD-5 A



1435  
MEAD  
MD-6 A



1436  
MEAD  
MD-7 A



1437  
MEAD  
MD-8

## Root Elevators



**1439**  
WINTER  
Fig. 1L



**1440**  
WINTER  
Fig. 1R



**1441**  
WINTER  
Fig. 2L



**1442**  
WINTER  
Fig. 2R



**1439**  
WINTER



**1443**  
WINTER  
Fig. 11L



**1444**  
WINTER  
Fig. 11R



**1445**  
WINTER  
Fig. 12L



**1446**  
WINTER  
Fig. 12R



**1447**  
WINTER  
Fig. 14L



**1448**  
WINTER  
Fig. 14R

## Root Elevators



**1449**  
BARRY  
Fig. 1



**1450**  
BARRY  
Fig. 2



**1451**  
BARRY  
Fig. 3



**1452**  
BARRY  
Fig. 4



**1449**  
BARRY



**1453**  
BARRY  
Fig. 11



**1454**  
BARRY  
Fig. 12



**1455**  
BARRY  
Fig. 17



**1456**  
BARRY  
Fig. 18

## Root Elevators



1458  
CRYER  
Fig. 26



1459  
SELDIN  
Fig. 27



1460  
CRYER  
Fig. 28



1461  
CRYER  
Fig. 29



1462  
HEIDBRINK  
Fig. 22



1463  
HEIDBRINK  
Fig. 23



1457



## Root Elevators



1465  
KOPP  
Fig. 31



1466  
KOPP  
Fig. 32



1467  
KOPP  
Fig. 33



1468  
KOPP  
Fig. 34



1469  
KOPP  
Fig. 35



1470  
KOPP  
Fig. 44

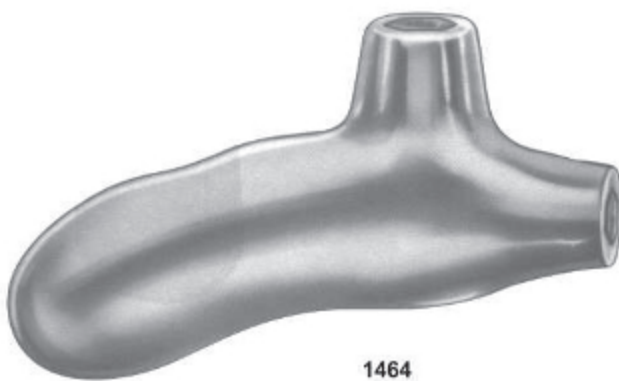

1464

## Root Elevators



**1472**  
HEIDBRINK  
Fig. 10



**1473**  
WINTER  
Fig. 11



**1474**  
WINTER  
Fig. 12



**1475**  
BARRY  
Fig. 17



**1476**  
BARRY  
Fig. 18



**1477**  
BARRY  
Fig. 20



**1471**

Root Elevators according to Dr. Sader,  
with interchangeable working tips



**1478**



**1479**



**1480**

## Elevator Plastic handle

1481  
Root Elevator, Plastic Handle, Set of 10 Pcs

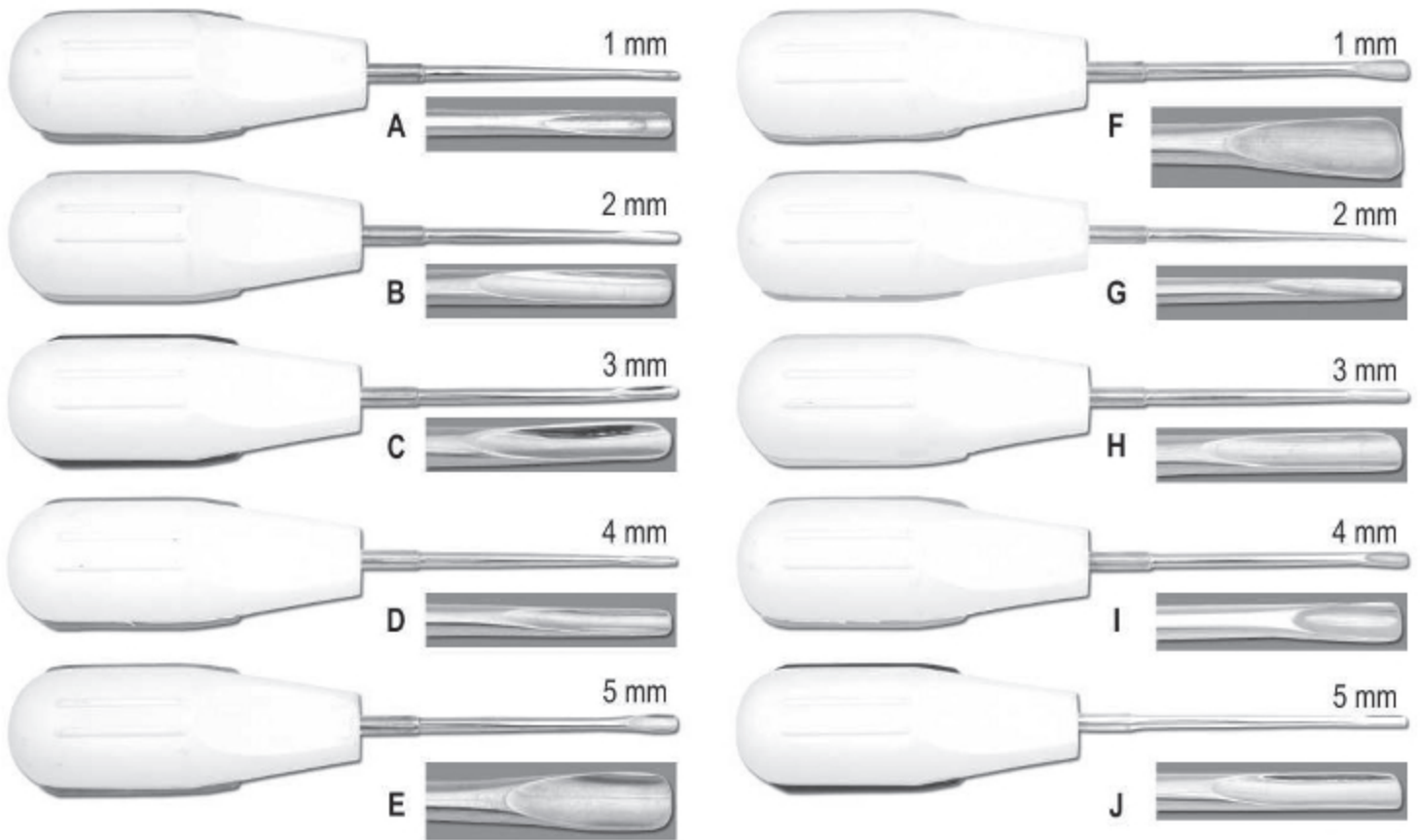

1482  
Root Elevator, Plastic Handle, Set of 5 Pcs

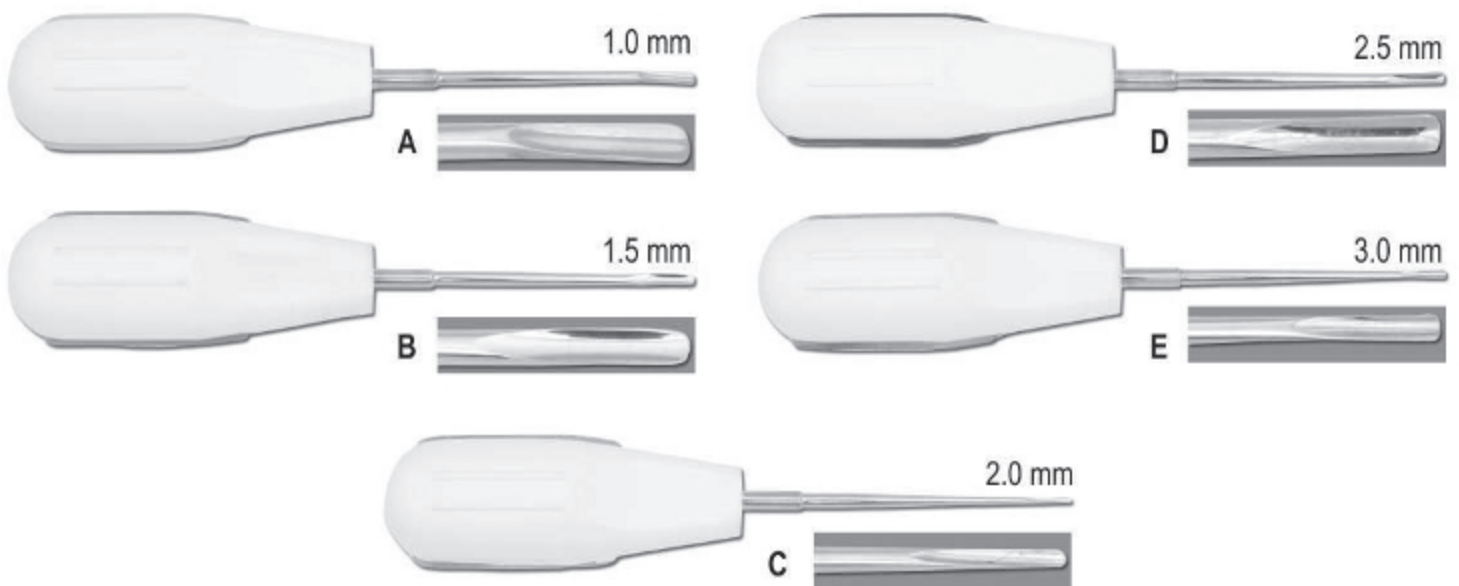

# SECTION 02



- ▶ Scalpel Handles
- ▶ Handles
- ▶ Explorers
- ▶ Condensers
- ▶ Mouth Mirrors
- ▶ Scalers
- ▶ Probes
- ▶ Excavators

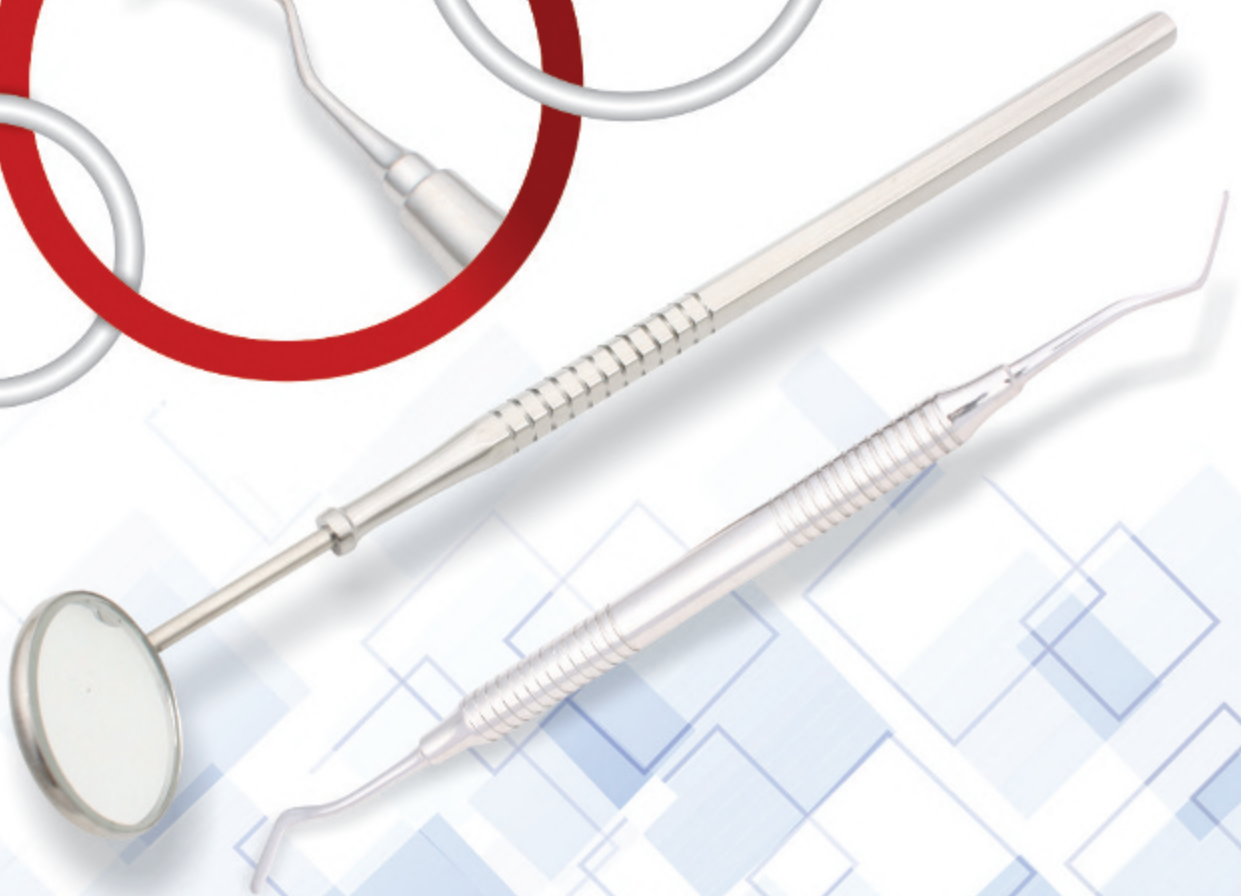

## Scalpel Handles



1483

Scalpel Handle Angle Of Blade Adjusts To Easily Get Around Corners  
Adjustment Sets Blade From Straight To Back Angled  
Locks In At 90°, 60°, 30°, Straight, -30°, -60° Angles



1484

Scalpel Handle  
Fig. 5



1485

Scalpel Handle  
Curved



1486  
Fig. 3L



1487  
Fig. 7



1488  
Scalpel Handle  
Fig. 4L, Curved  
20 cm



1489  
Fig. 3



1490  
Fig. 3G



1491  
Fig. 4



1492



1493  
Scalpel Handle  
4 D 14.0 cm



1494  
Mess Holders



1495  
Gouge  
Blade Handle  
Fig. 2 / 11.5 cm

## Handles

Handle For Mouth Mirrors, Probes, Explorers, Excavators, Carvers, Curettes & Scalers



**1496**

Handle No. 2 Standard Single Ended

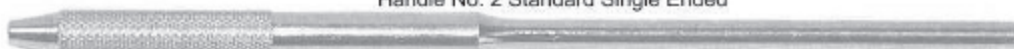

**1497**

Handle Single Ended



**1498**

Handle Single Ended



**1499**

Handle Single Ended



**1500**

Octagonal Double Ended

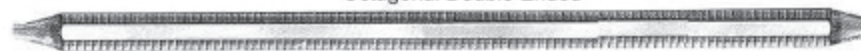

**1501**

Octagonal Double Ended



**1502**

Octagonal Double Ended

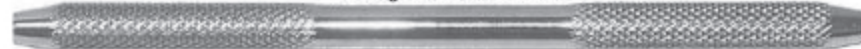

**1503**

Handle No. 2 (Standard Double Ended)



**1504**

Octagonal Double Ended



**1505**

Tactile Tone Double Ended



**1506**

Tactile Tone Double Ended

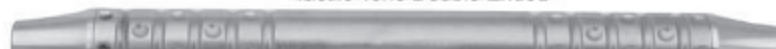

**1507**

Tactile Tone Double Ended

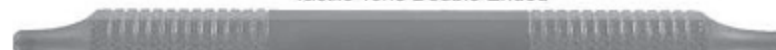

**1508**

Handle, Double Ended



**1509**

Double Ended



**1510**

Tactile Tone Double Ended

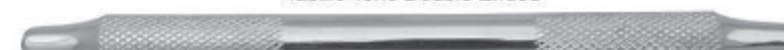

**1511**

Tactile Tone Double Ended

## Handles & Mouth Mirrors

### Mouth Mirrors, Magnifying 1513-A Plain 1512-B

Fig. 00	Ø	8 mm
Fig. 0	Ø	10 mm
Fig. 1	Ø	14 mm
Fig. 2	Ø	16 mm
Fig. 3	Ø	18 mm
Fig. 4	Ø	20 mm
Fig. 5	Ø	22 mm
Fig. 6	Ø	24 mm
Fig. 7	Ø	26 mm
Fig. 8	Ø	28 mm
Fig. 9	Ø	30 mm
Fig. 10	Ø	32 mm



### Mouth Mirrors

#### Plane



#### Magnifying



#### Front surface



#### Plane



With cone - socket

#### Magnifying



## Mirror Handle, Mouth Mirrors



1529



1530



1531



1532



1533



1534



1535  
Parallelometer  
mouth mirror

1536  
Parallelometer  
mouth mirror  
+ handle  
code 2101



1537  
Tactile Tone  
Single Ended



1538  
Handle  
Thompson  
Single Ended



1539  
Hollow Handle



1540  
Hollow Handle  
Stainless  
Steel



1541  
Cone-socket  
Hollow Handle



1542  
Hollow Handle



1543  
Hollow Handle



**Scalers**

SCALERS - JAQUETTE

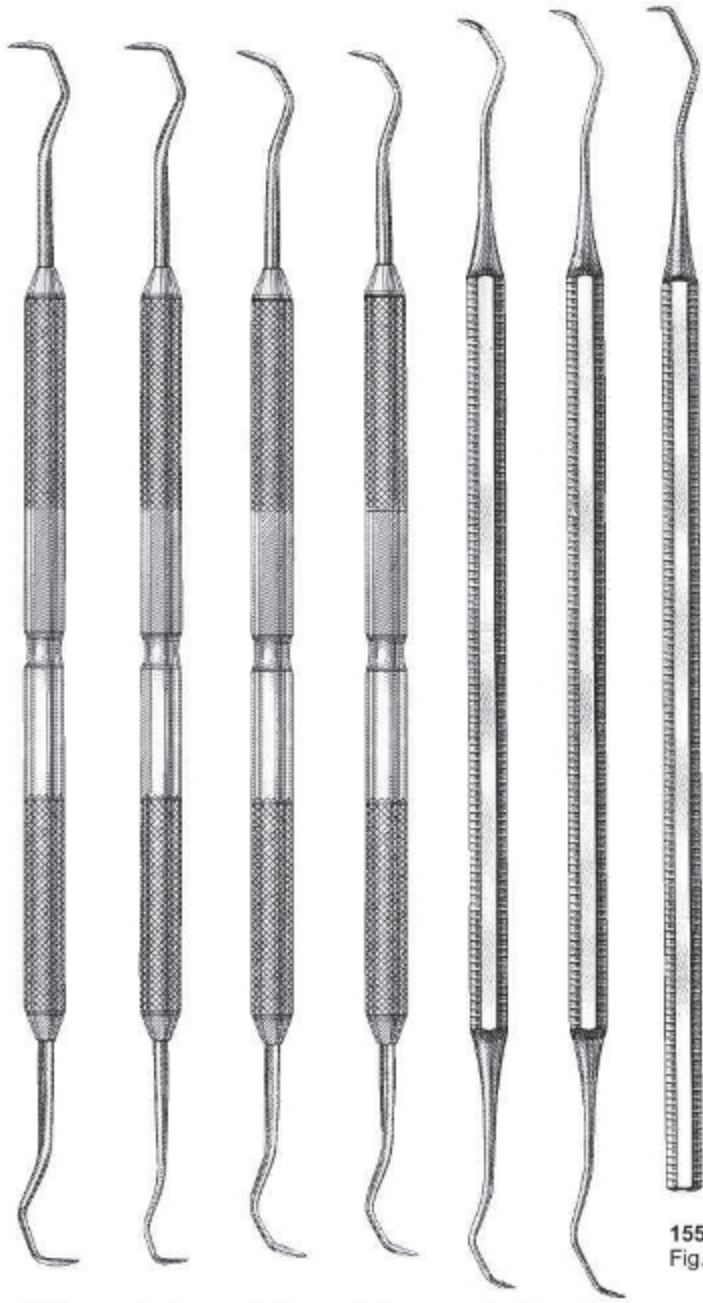

1544 1Y-1Y  
1545 1Y-1YS  
1546 2Y-3Y  
1547 2YS-3YS  
1548 2-3  
1549 2S-3S

SCALERS - OCTAGONAL

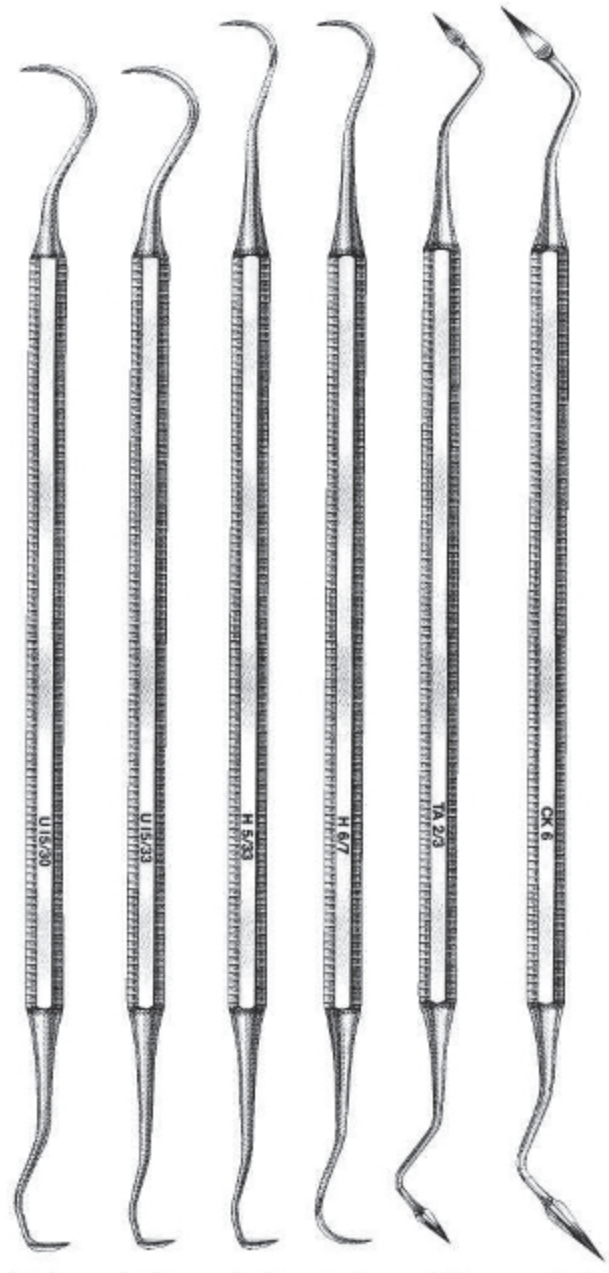

1551 U15-30  
1552 U15-33  
1553 H5-33  
1554 H6-7  
1555 Taylor 2-3  
1556 CK6

1550  
Fig.1

## Scalers



1557  
U15



1558  
No. 3



1559  
No. 12



1560  
WHITESIDE 1-0



1561  
WHITESIDE 2-0

## Scalers



**1562**  
YAOUNGER/GOOD  
7-8



**1563**  
H5-33



**1564**  
204SD



**1565**  
H6-7



**1566**  
204S



**1567**  
TOWNER/JAQUETTE  
U15-30

## Scalers



**1568**  
JAQUETTE (33-U15)



**1569**  
JAQUETTE  
2Y-3Y



**1570**  
JAQUETTE  
30-U15



**1571**  
JAQUETTE  
2YS-3YS



**1572**  
JAQUETTE  
33-H5



**1573**  
YOUNGER/GOOD  
7-8



**1574**  
204S



**1575**  
204SD



**1576**  
H6-7



**1577**  
JAQUETTE  
2S-3S



**1578**  
JAQUETTE  
1Y-1YS



**1579**  
JAQUETTE  
2-3

# Scalers



1580  
JAQUETTE (33-U15)



1581  
S204



1583  
S204S



1585  
S204SD



1587  
Goldman 6-7



1589  
Goldman Fox 21



1591  
H5-U15



1593  
Jaquette 34-35



1595  
Thompson Jr.



1597  
UT107-108



1599  
UP128



1582  
Jack-Nebraska



1584  
Jaquette 1-U15



1586  
Jaquette 2-3



1588  
Jaquette 2S-3S



1590  
Jaquette 30-U15



1592  
Jaquette 30-33



1594  
Jaquette 31-32



1596  
Jaquette 33-H5



1598  
U 6-7



1600  
128L

## Explorers

### Explorers Double Ended - Octagonal

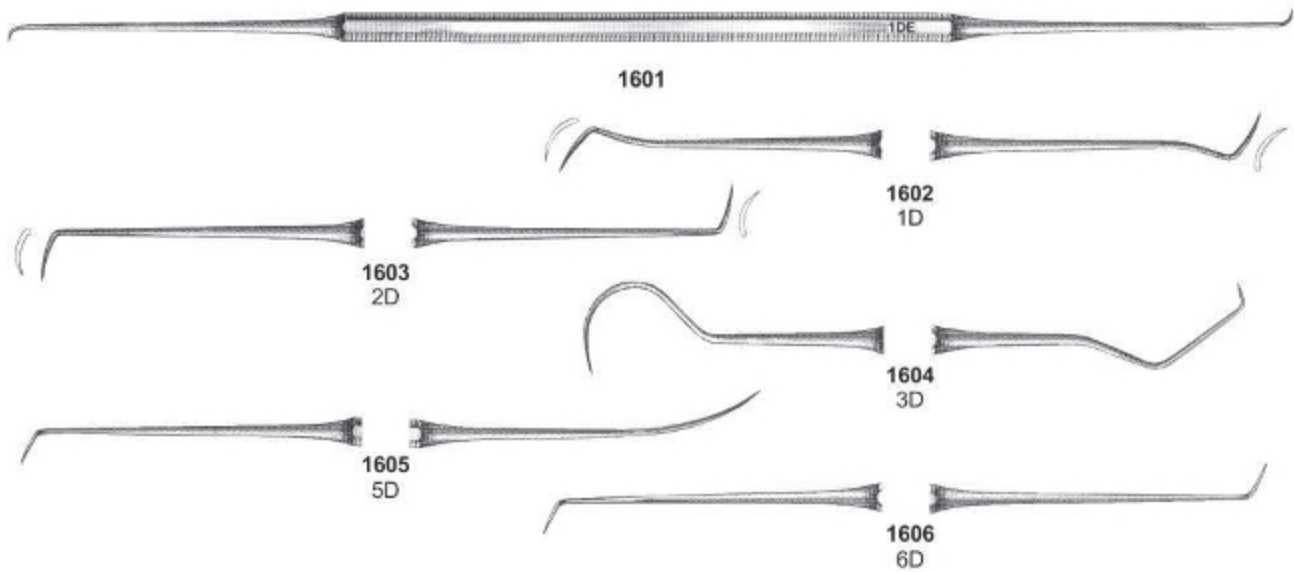

### Explorers Double Ended - Standard

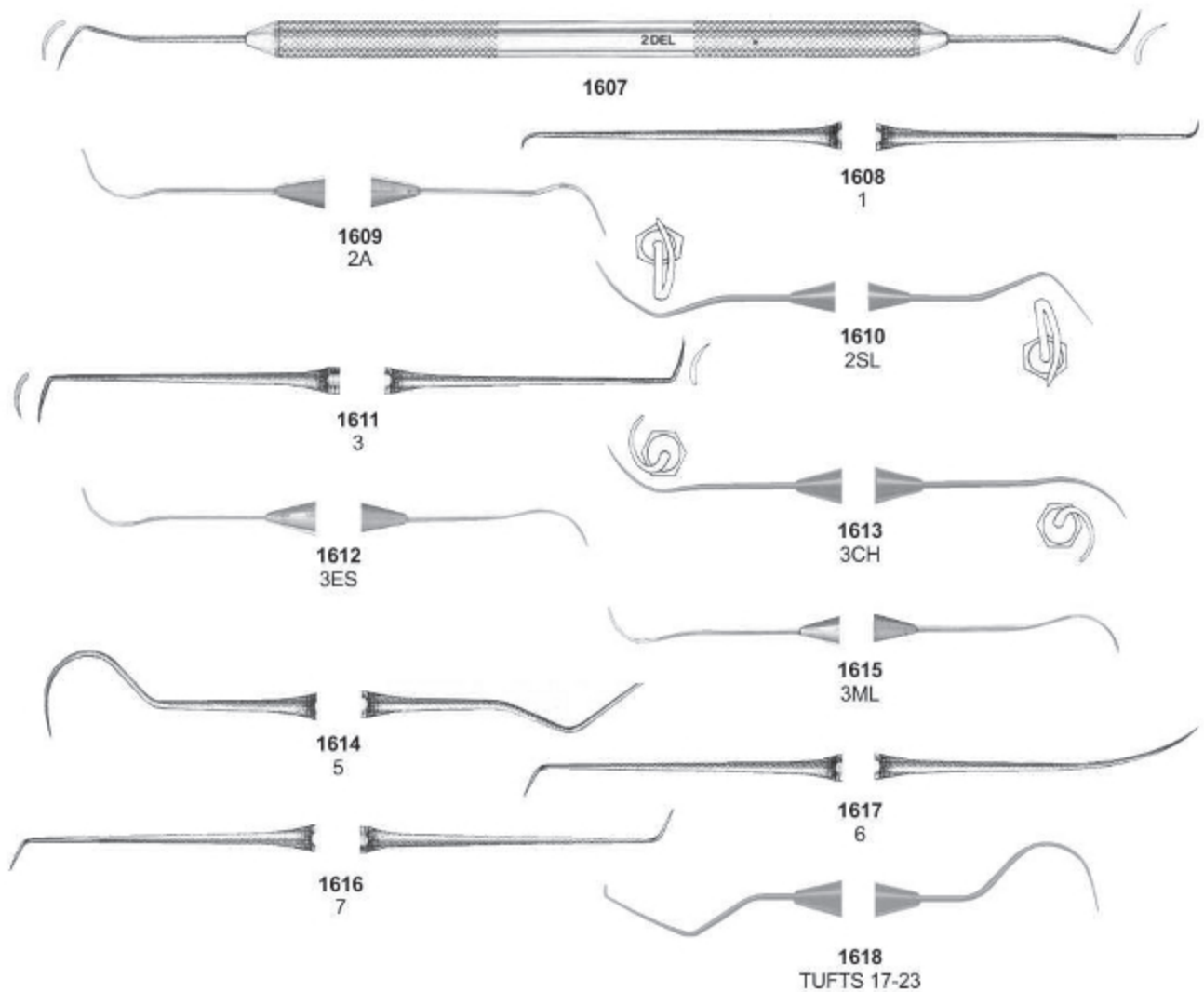

Explorers Double Ended Tactile Tone



1619  
2A



1620  
2



1621  
1



1622  
2SL



1623  
3



1624  
3CH



1625  
3ES



1626  
3ML



1627  
5



1628  
6



1629  
7



1630  
16



1631  
TUFTS 17/23

## Explorer & Probes

### Explorers Single Ended - Octagonal

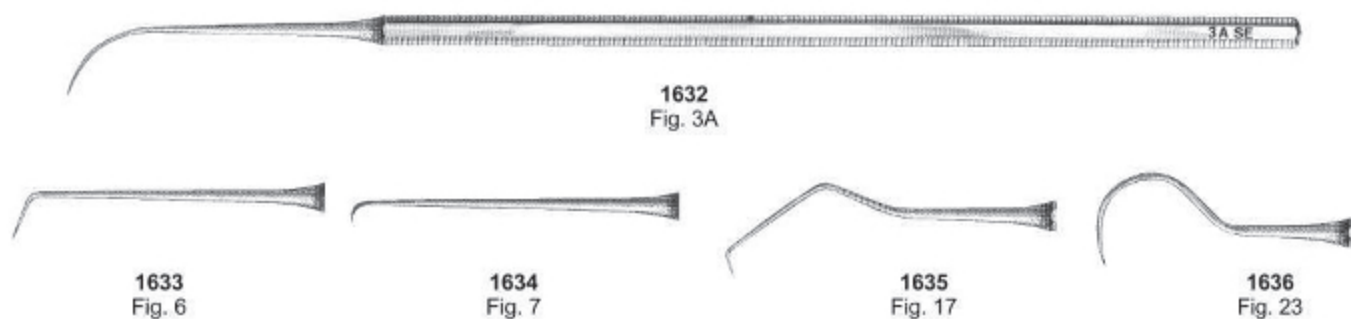

### Explorers Single Ended - Standard

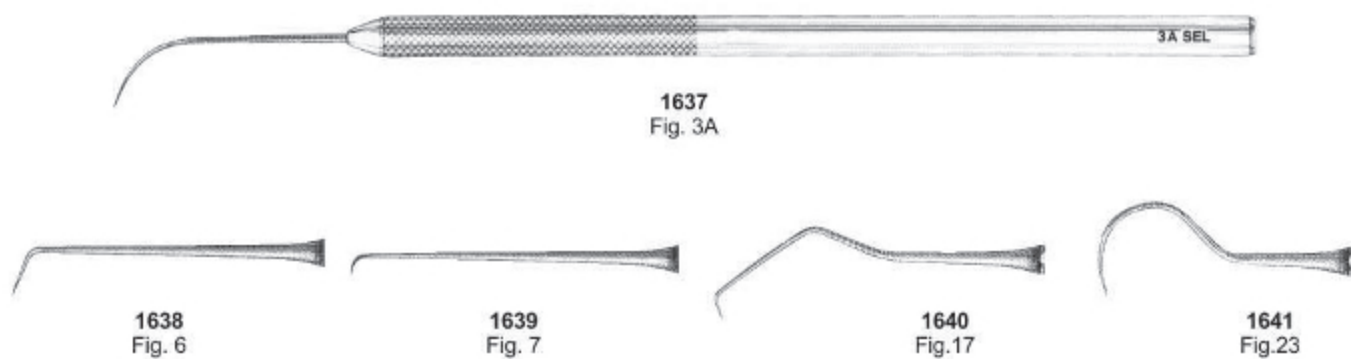

### Probe / Explorer - Octagonal



### Double Ended Probe - Octagonal





**Probes**

Probes Double Ended - Standard

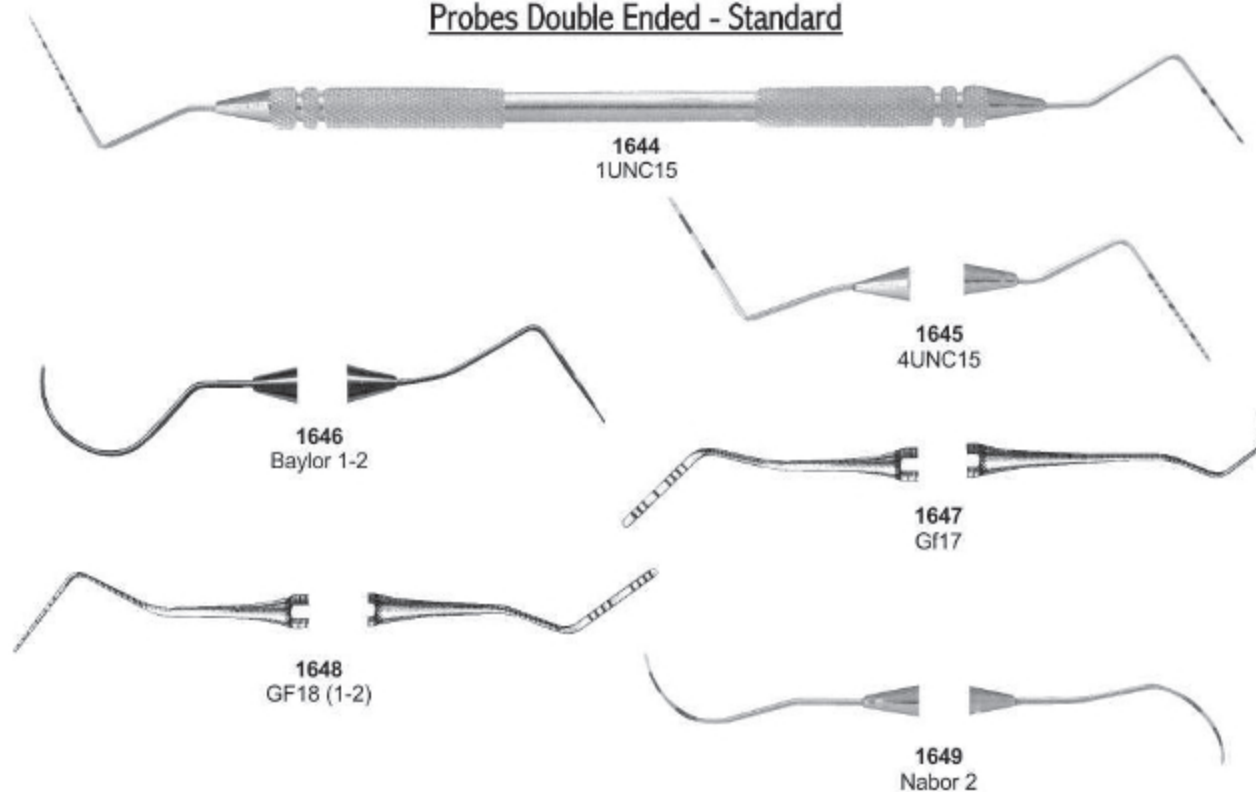

Probes Double Ended - Tactile Tone

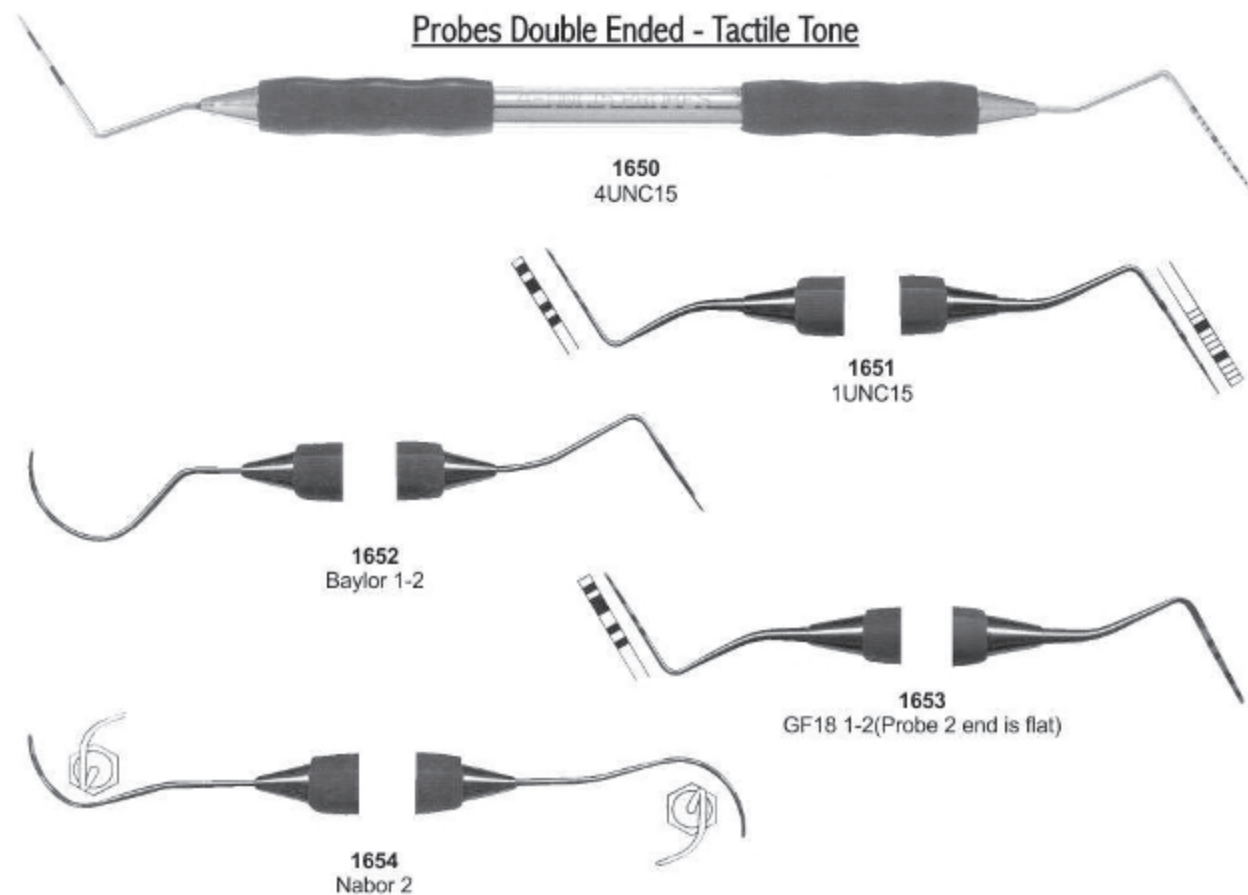

## Probes

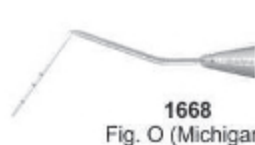
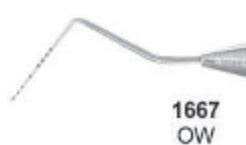
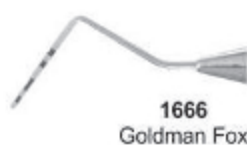
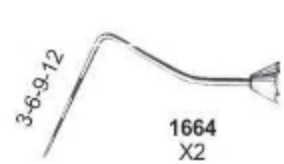
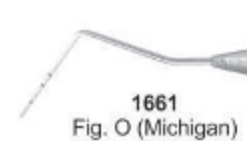
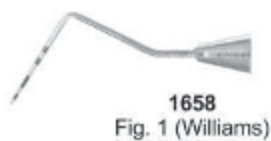
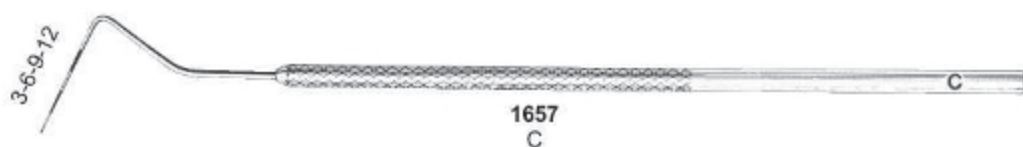
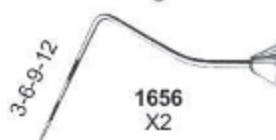
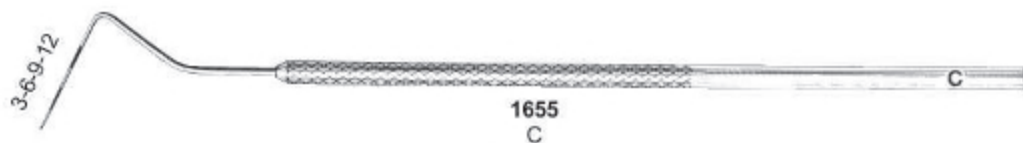

**Probes**

**PROBES DOUBLE ENDED STANDARD**

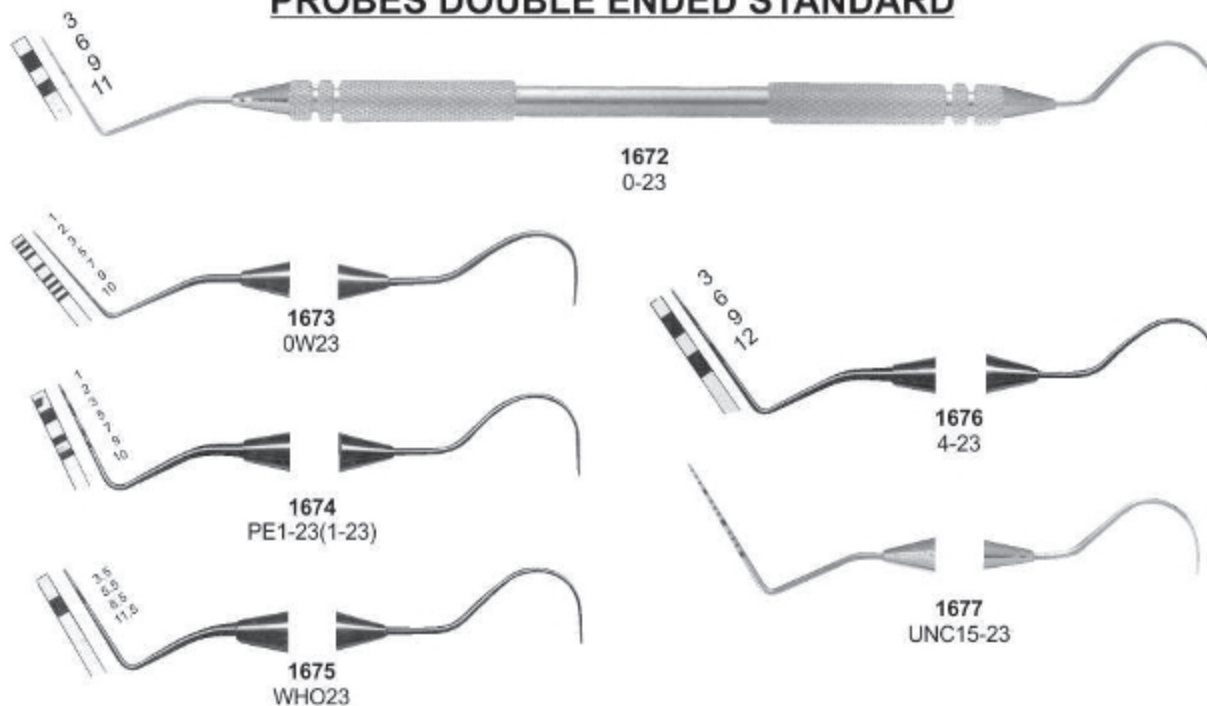

**PROBES DOUBLE ENDED TACTILE TONE**

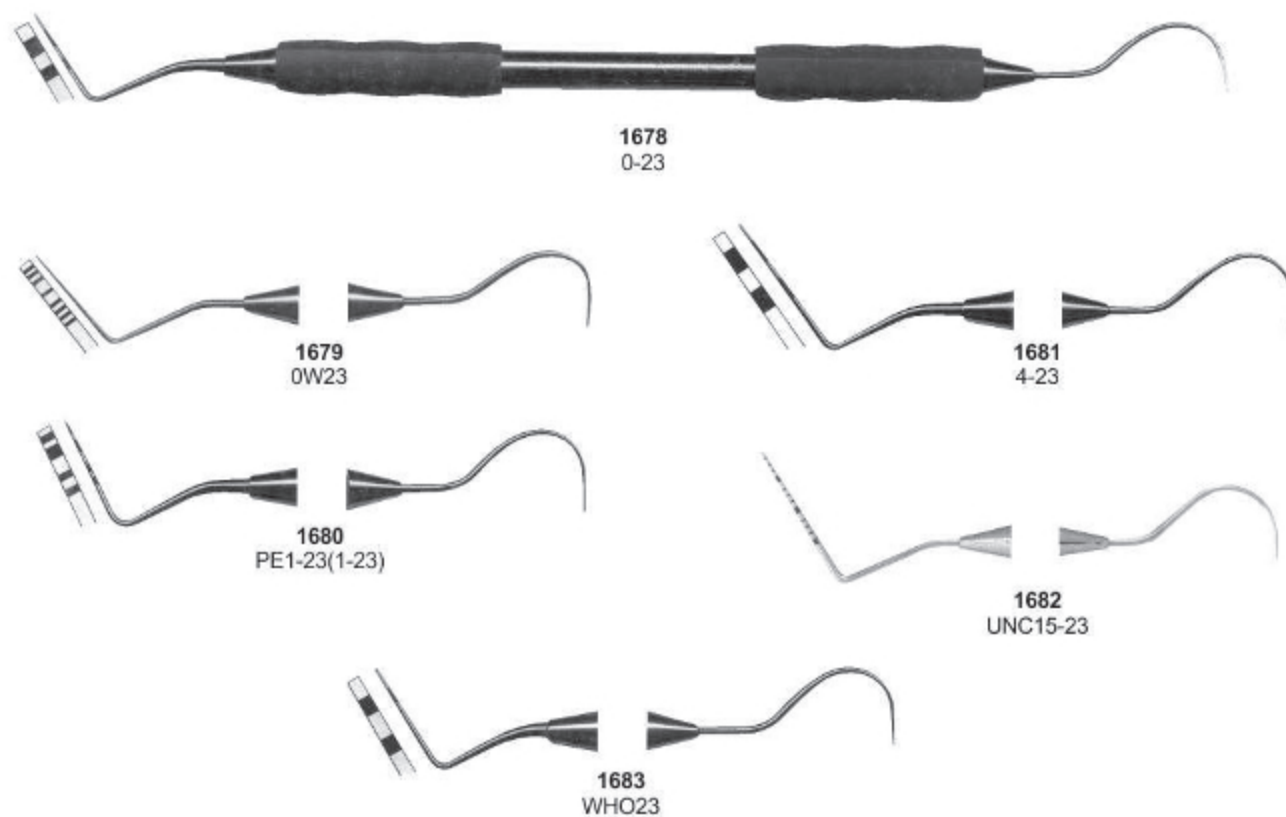

## Endodontic Condensers

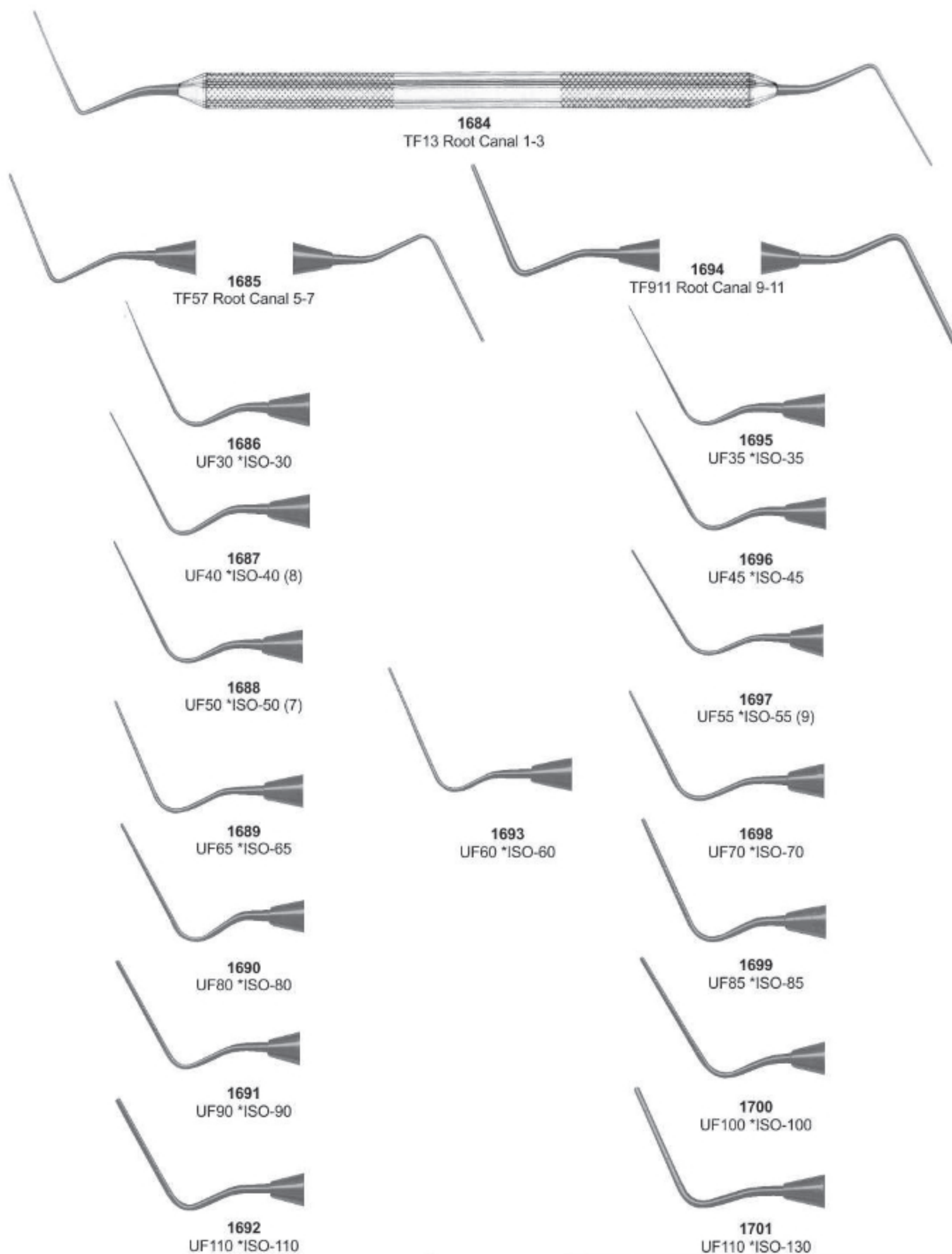

## Endodontic Condensers / Spreaders

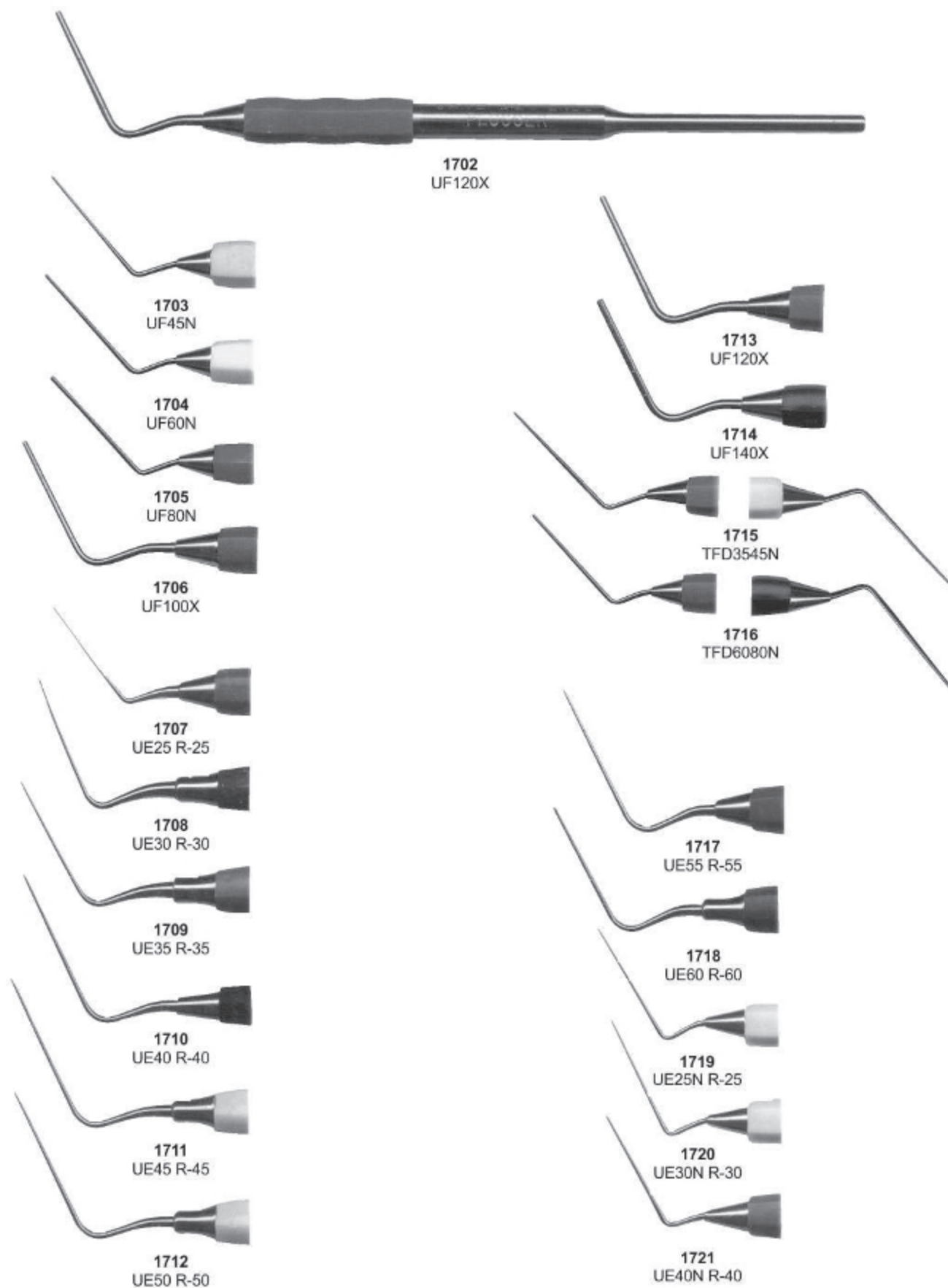

## Obturation Instruments

**1722**  
No. D11



**1723**  
No. D11T



**1724**  
No. KR1



**1725**  
No. 25S



**1726**  
No. W1S



**1727**  
No. W2S

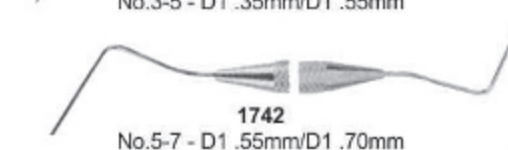
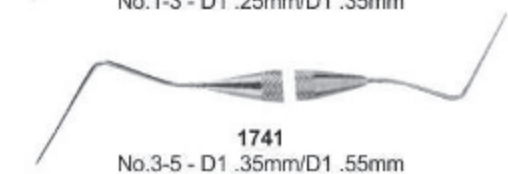
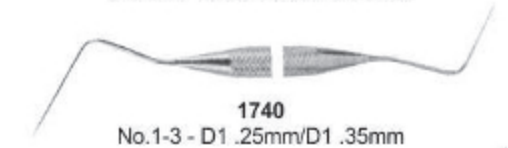
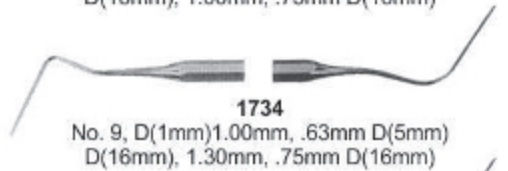
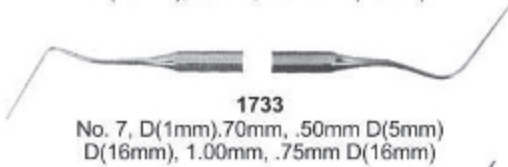

## Excavators

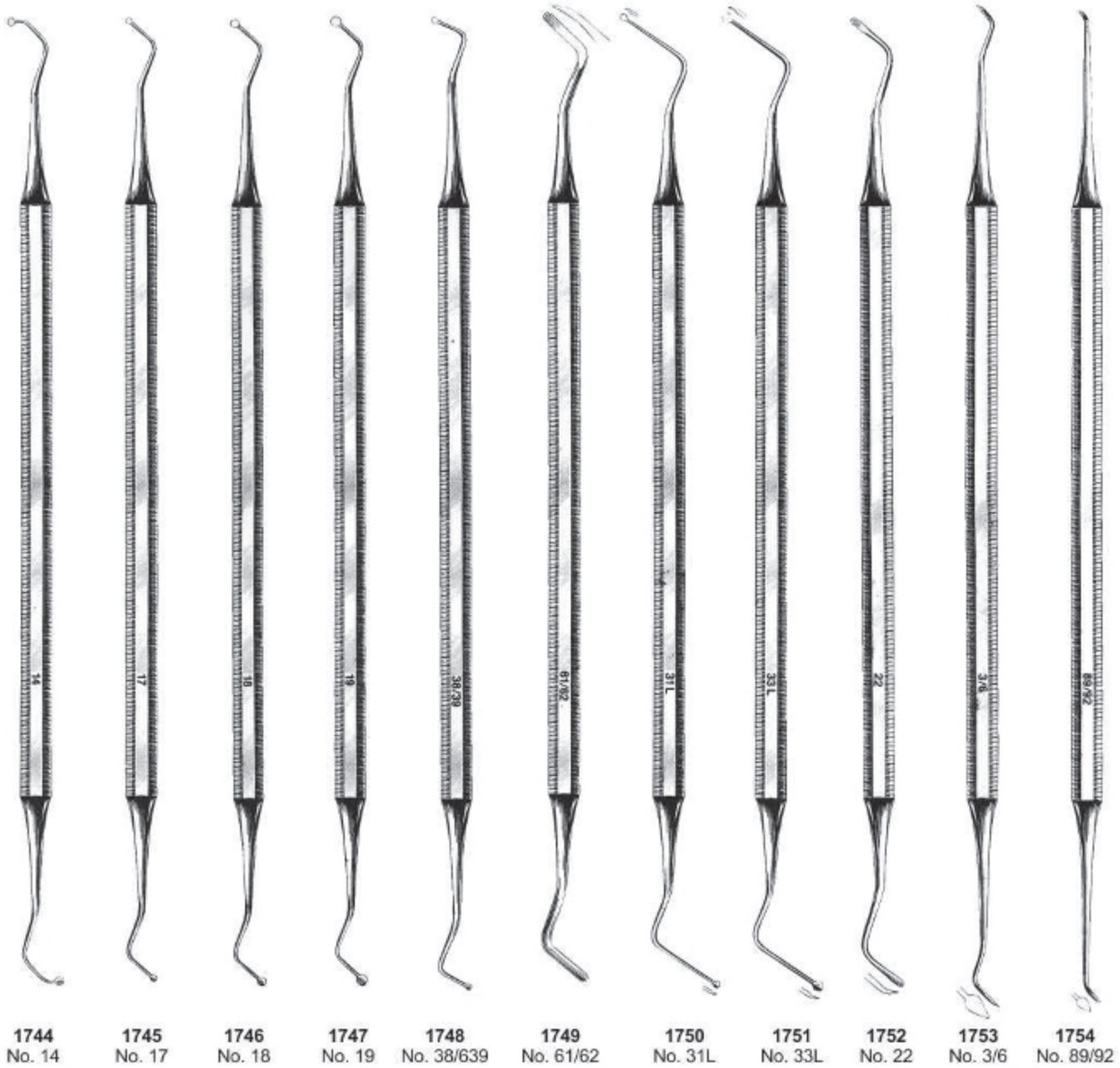

## Excavators





## Excavators, Explorer / Probes

### Excavators

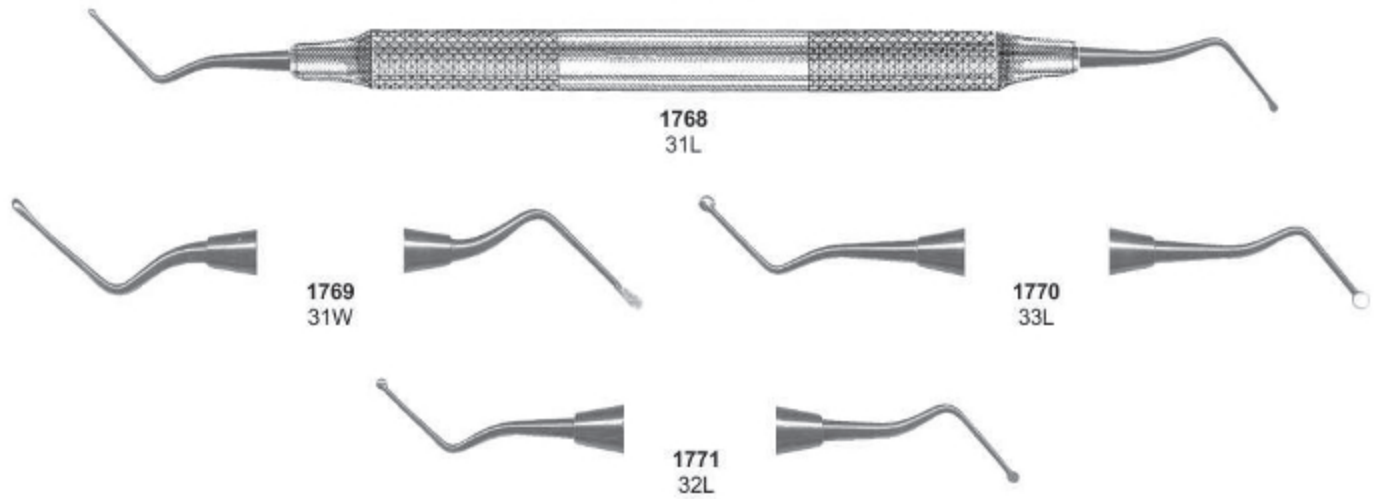

### Explorers / Probes

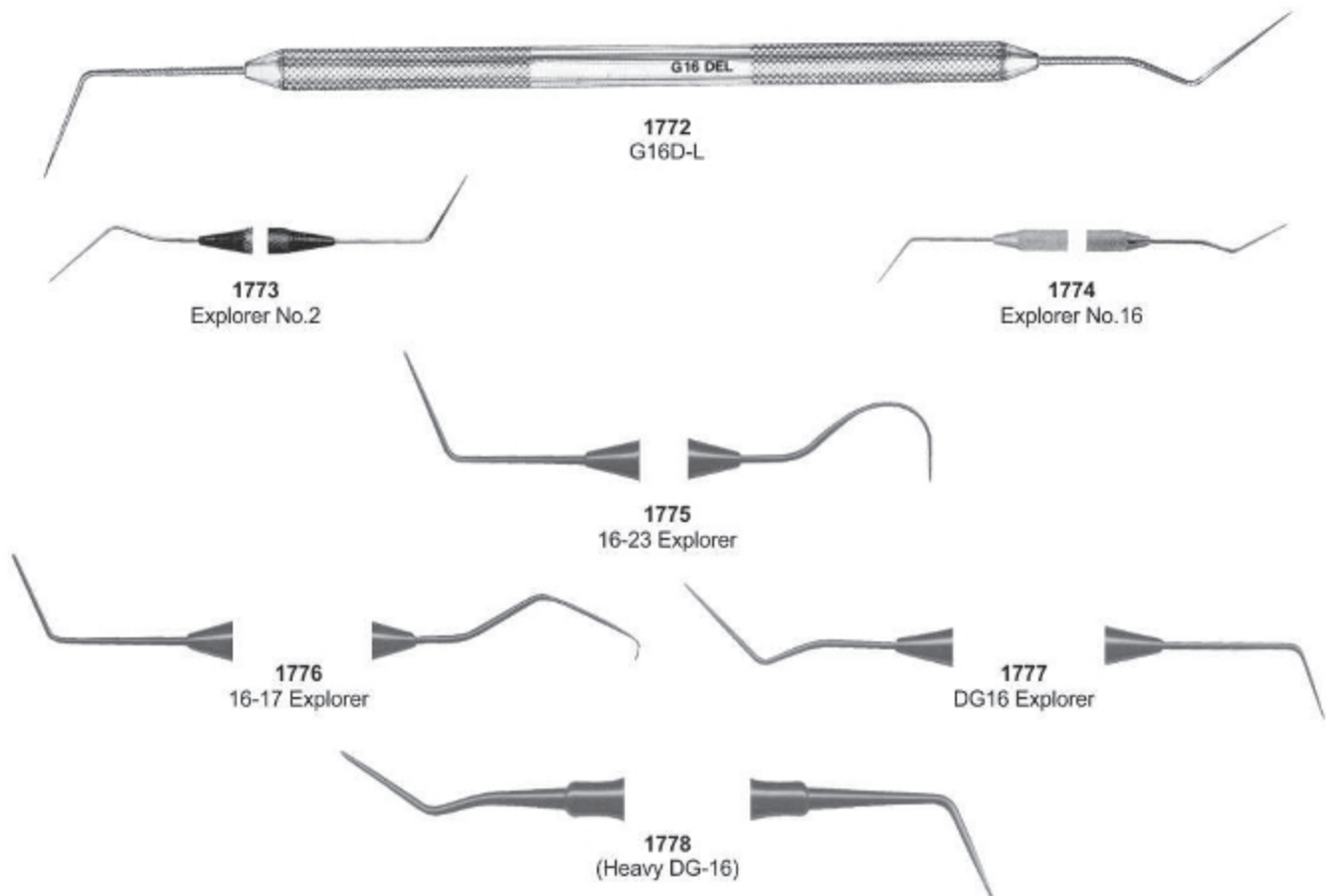

## Explorers



## Explorers

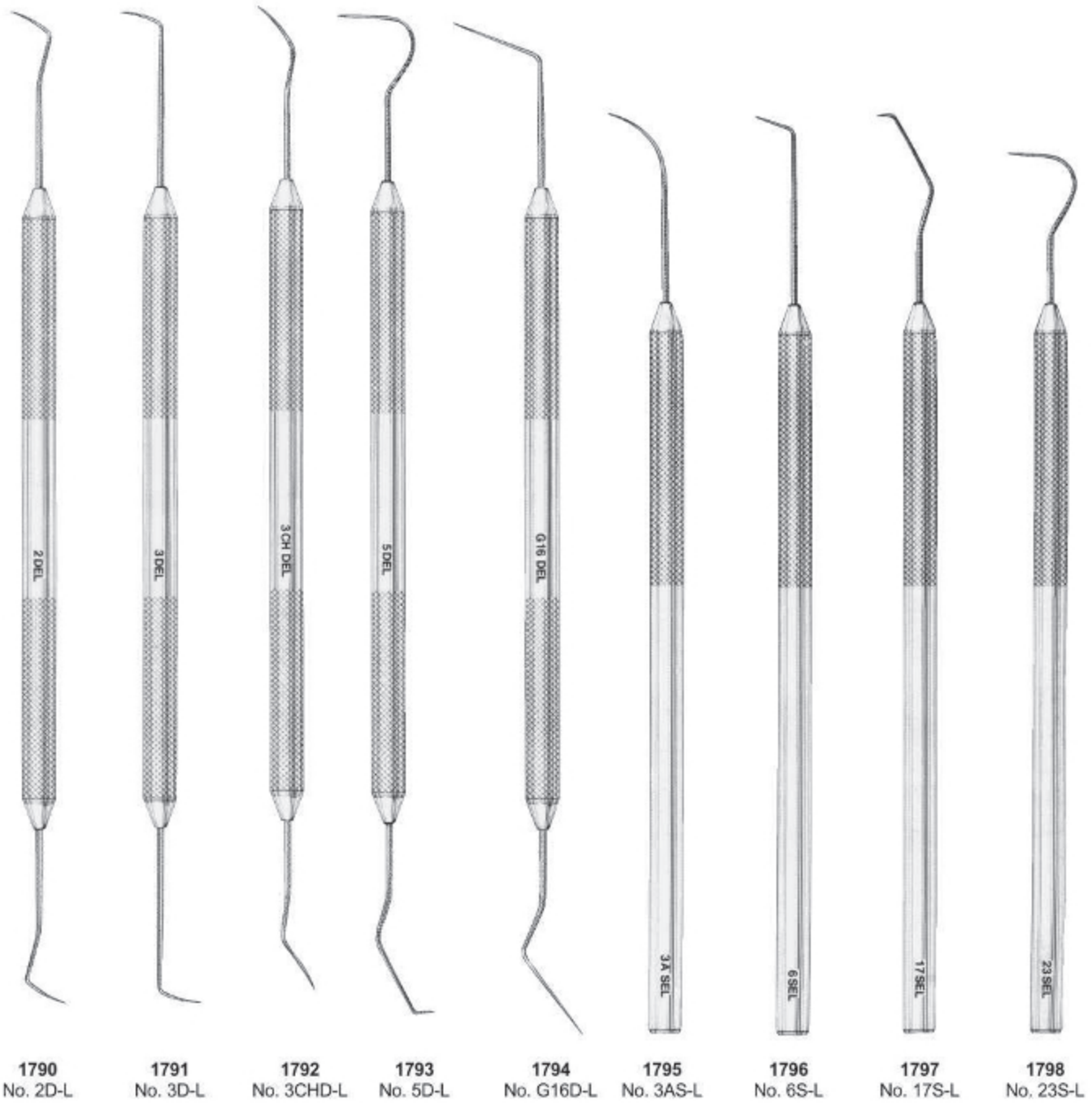

## Explorer / Probe Combination

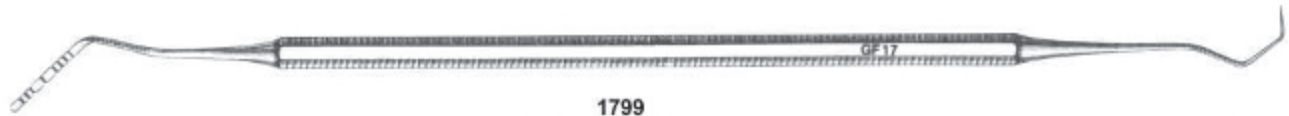

**1799**  
Gf17 Probe/Explorer

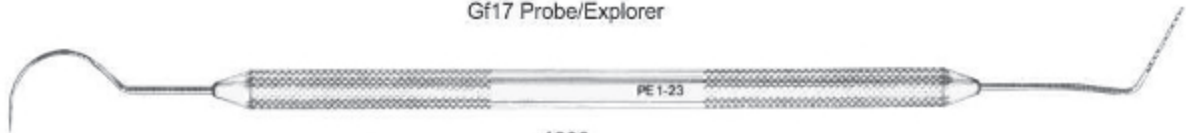

**1800**  
PE 1-23 Probe/Explorer

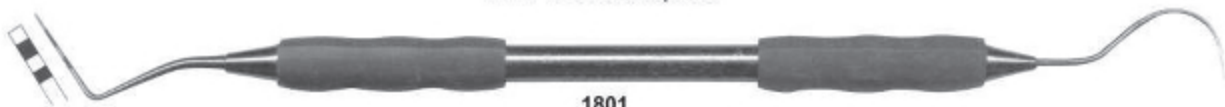

**1801**  
Probe 0 / 23 Explorer (fine)



**1802**  
Probe 1 / 23 Explorer



**1804**  
Probe 4 / 23 Explorer



**1803**  
Probe OW / 23 Explorer

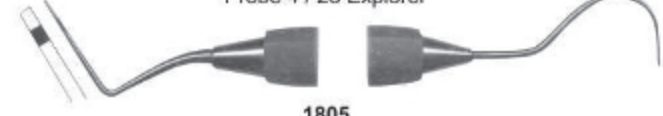

**1805**  
Ball Tip Probe WHO / 23 Explorer

## PROBES



**1806**  
Gf18 Probe



**1807**  
"C" Probe



**1808**  
X2 Probe



**1809**  
1-2 (Probe 2 end is flat)



**1810**  
1 UNC 15



**1811**  
4 SE

## Cord Packers, Hatchets, Hoes

### CORD PACKERS



1812

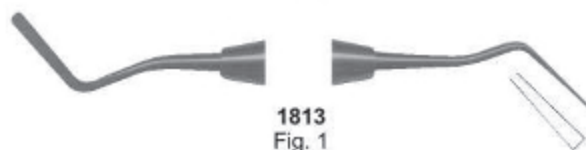

1813  
Fig. 1



1814  
Fig. 2



1815  
BLOOMFIELD  
Fig. 2 (off angle)



1816  
Fig. 1



1817  
CSI-1 (slightly serrated on ends)



### HATCHETS



1818  
1mm (10-7-14)



1819  
1.3mm (13-10-16)



1820  
1.5mm (15-8-14)



### HOES

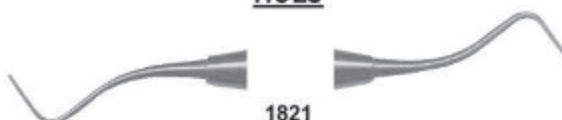

1821  
1mm (10-8-16)



1822  
UWH 18-19



1823  
UWH 16-18



1824  
UWH 20-21

## P.K.Thomas waxing & Gracey Curettes Set



1825  
P.K.Thomas 1



1826  
P.K.Thomas 2



1827  
P.K.Thomas 3



1828  
P.K.Thomas 4

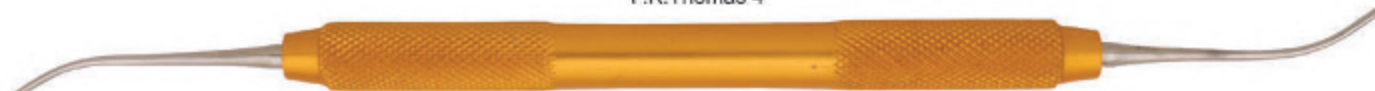

1829  
P.K.Thomas 5

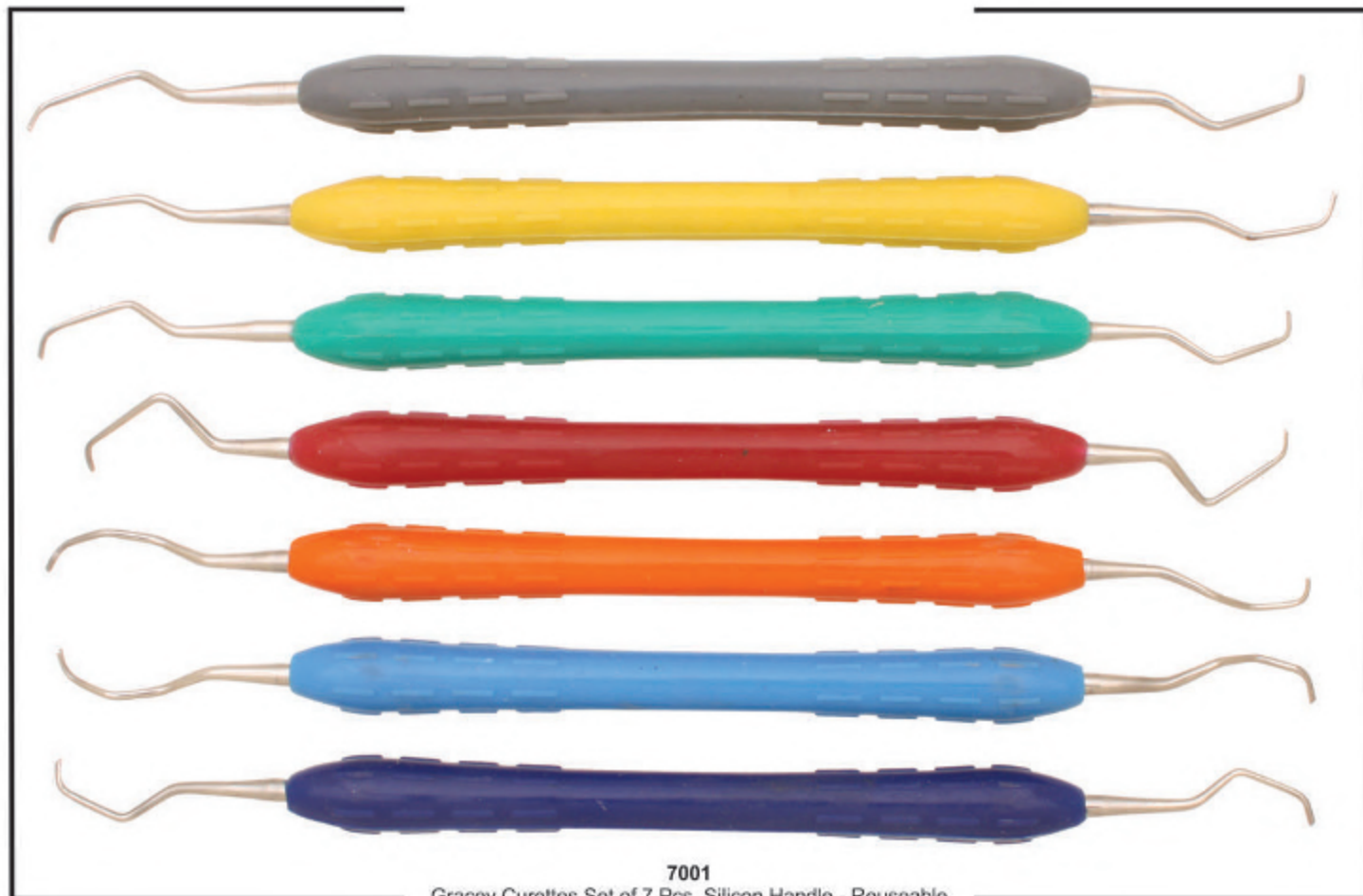

7001  
Gracey Curettes Set of 7 Pcs, Silicon Handle - Reuseable

## Amalgam Plugger / Condensers / Applicators

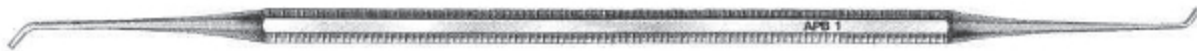

**1830**  
BEHRMAN (Fig. 1)



**1831**  
BLACK (Fig. 1-2)



**1832**  
MORQUETTE (Fig. 0/1)



**1833**  
Black Action 11/12 Plugger



**1834**  
Hollenback No. 1 Plugger



**1835**  
Hollenback No. 2 Plugger



**1836**  
Hollenback No. 3 Plugger



**1837**  
Blacks 0-1 (1mm-1.5mm)



**1838**  
Blacks 1-2 (1.5mm-2.5mm)

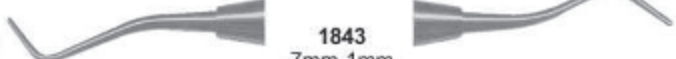

**1843**  
.7mm-1mm



**1839**  
Bodkin 1 (.7mm-1mm)



**1844**  
1mm-1.5mm



**1840**  
Bodkin 2 (1.5mm-2mm)

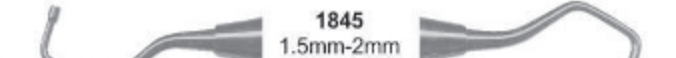

**1845**  
1.5mm-2mm



**1841**  
2.5mm-3mm



**1846**  
Oregon (Fig. 3)

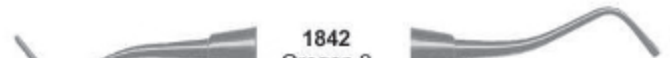

**1842**  
Oregon 2



**1847**  
Oregon (Fig. 4)



**1848**  
UP 12



**1849**  
Applicator 1-2



**1850**  
Birtles Applicator Spatula



**1851**  
Birtles Applicator Spatula K

## Placement Instruments "Plugger"

### Placement Instruments

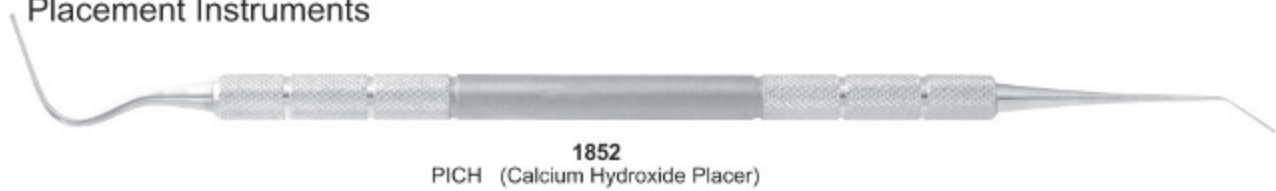

### Stopping Stoppers



### Plugger





# SECTION 03



- ▶ Burnishers
- ▶ Chisels
- ▶ Filling Instruments
- ▶ Disposable Instruments
- ▶ Composite Placements
- ▶ Carvers
- ▶ Curettes



## Burnishers



1864  
Fig. 1



1865  
Fig. 28/29



1866  
Fig. 34



1867  
Fig. 27/29



1868  
Fig. 21B



1869  
ACORN  
Fig. 21

## Burnishers

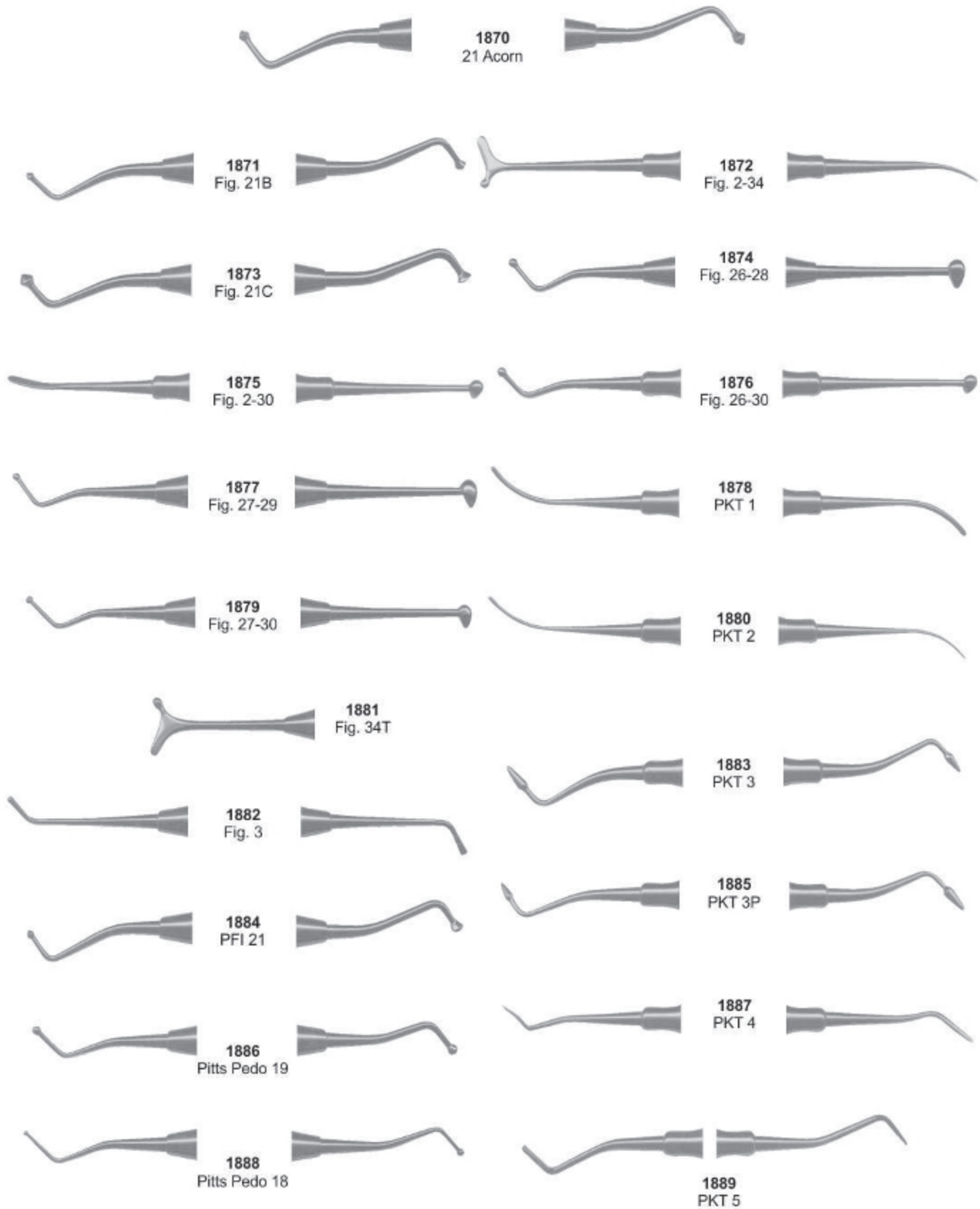

## Wax Carvers



**1890**  
HOLLENBACK  
Fig. 3



**1891**  
HOLLENBACK  
Fig. 3S



**1892**  
WARD  
Fig. 1



**1893**  
WARD  
Fig. 2



**1894**  
WALL  
Fig. 1



**1895**  
WALL  
Fig. 3



**1896**  
Fig. 3/6  
Cleoid/Discoïd



**1897**  
Fig. 89/92  
Cleoid/Discoïd

## Carvers



**1898**  
1.5mm Cleoid Discoid (Shown with GTX Finish)

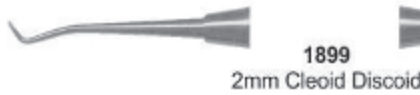

**1899**  
2mm Cleoid Discoid



**1900**  
GOLLOBIN  
Fig. 1



**1901**  
3mm Cleoid Discoid

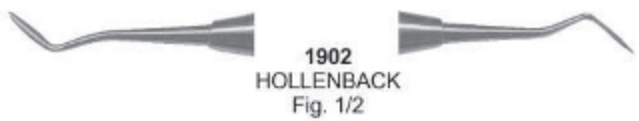

**1902**  
HOLLENBACK  
Fig. 1/2



**1903**  
FRAHM  
Fig. 2-3 (off-angle)



**1904**  
HOLLENBACK  
Fig. 3



**1905**  
Interproximal 1



**1906**  
THOMPSON (Fig. 3)  
( $\frac{1}{2}$  Hollenback Hoe & Wall 3)



**1907**  
Interproximal 1



**1908**  
THOMPSON (Fig. 5)  
( $\frac{1}{2}$  Hollenback Hoe & Tanner 5)



**1909**  
Baum Interproximal



**1910**  
THOMPSON (Fig. 8)  
(3mm Cleoid & Wall 3)



**1911**  
Sho A Carver



**1912**  
THOMPSON (Fig. 9)  
(Hollenback 3 & Wall 3)



**1913**  
Thompson 2



**1914**  
WARD  
Fig. 2

## Carvers, Chisels

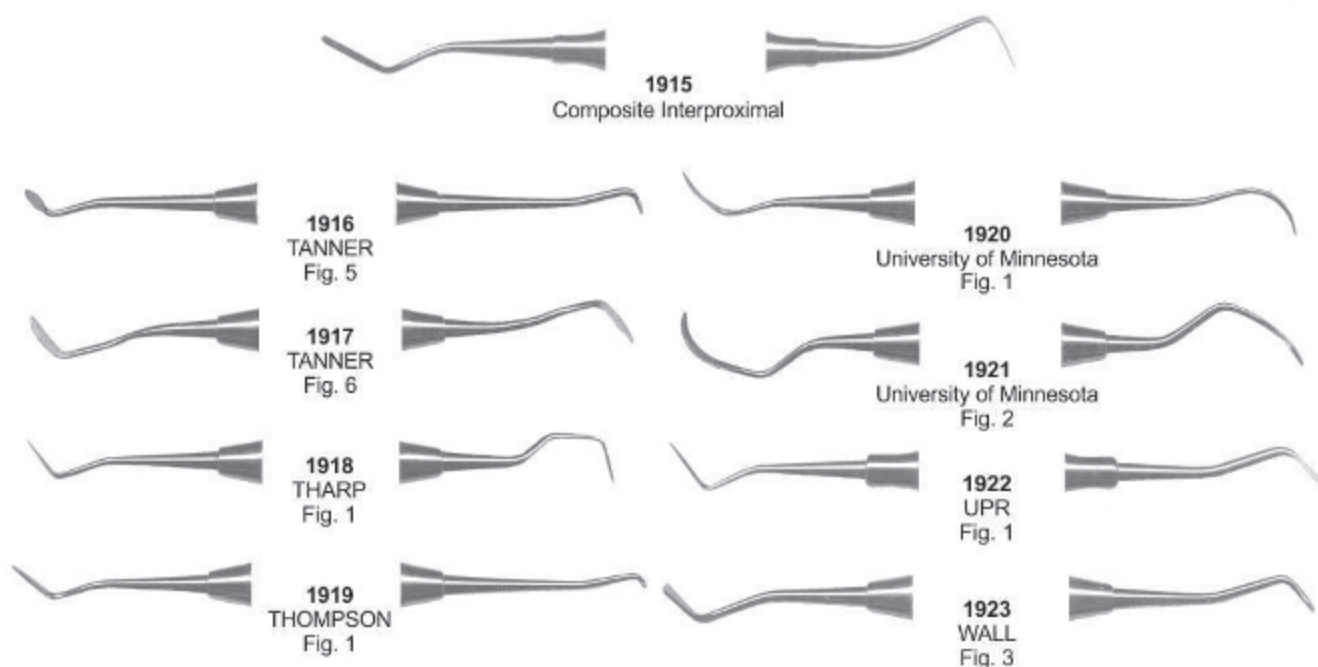

### Contour Carbide Carvers - Finishing



### Chisels

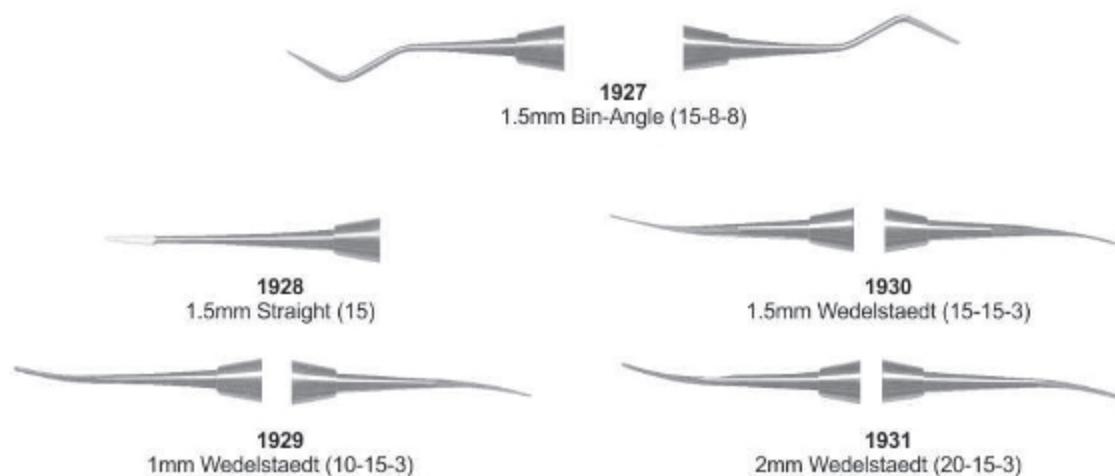

## Composite Placement

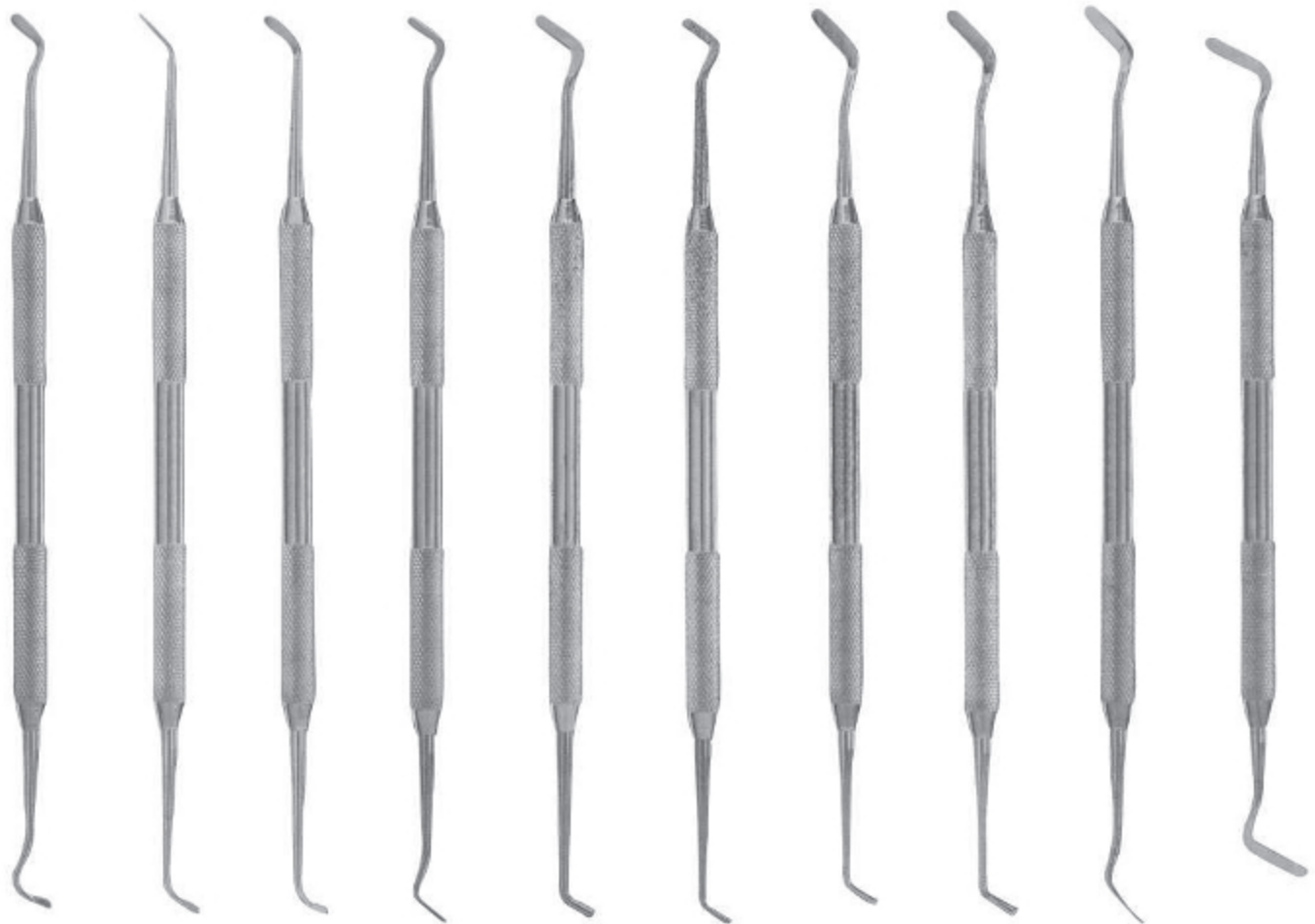

1932 F-Type 1    1933 F-Type 2    1934 F-Type 3    1935 F-Type 4    1936 F-Type 5    1937 F-Type 6    1938 G-Type 1    1939 G-Type 2    1940 G-Type 3    1941 G-Type 4

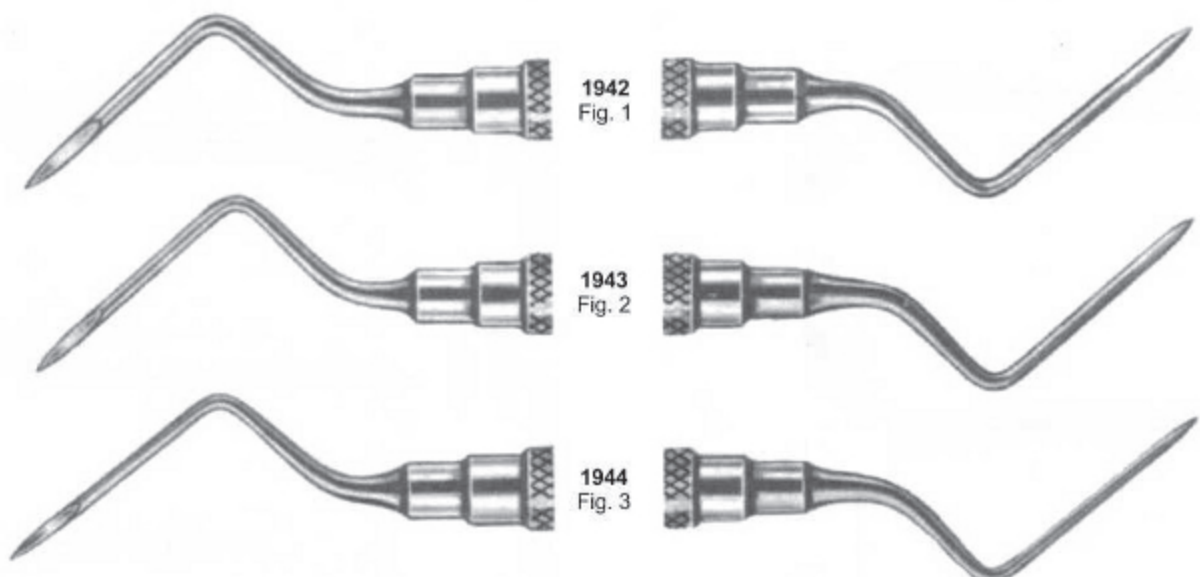

## Composite Placement



1945  
Fig. 2



1946  
Fig. 3 (off-set blade)



1947  
Fig. 4



1948  
Fig. 5



1954  
Fig. 12



1949  
Fig. 6



1950  
Fig. 7



1951  
Fig. 8



1955  
Fig. 15



1952  
Fig. 9



1953  
Fig. 11



1956  
JORDAN  
Fig. 2



1957  
FREEDMAN  
Fig. 1



1958  
FREEDMAN  
Fig. 2



1959  
FREEDMAN  
Fig. 3



1960  
Dr. Dan



1961  
SIMON  
Fig. 2



### K - Type

1962  
K-Type 1



1963  
K-Type 2



1964  
K-Type 3



1965  
K-Type 4



1966  
K-Type 5



1967  
K-Type 6 Carbide



## Plastic Filling Instruments

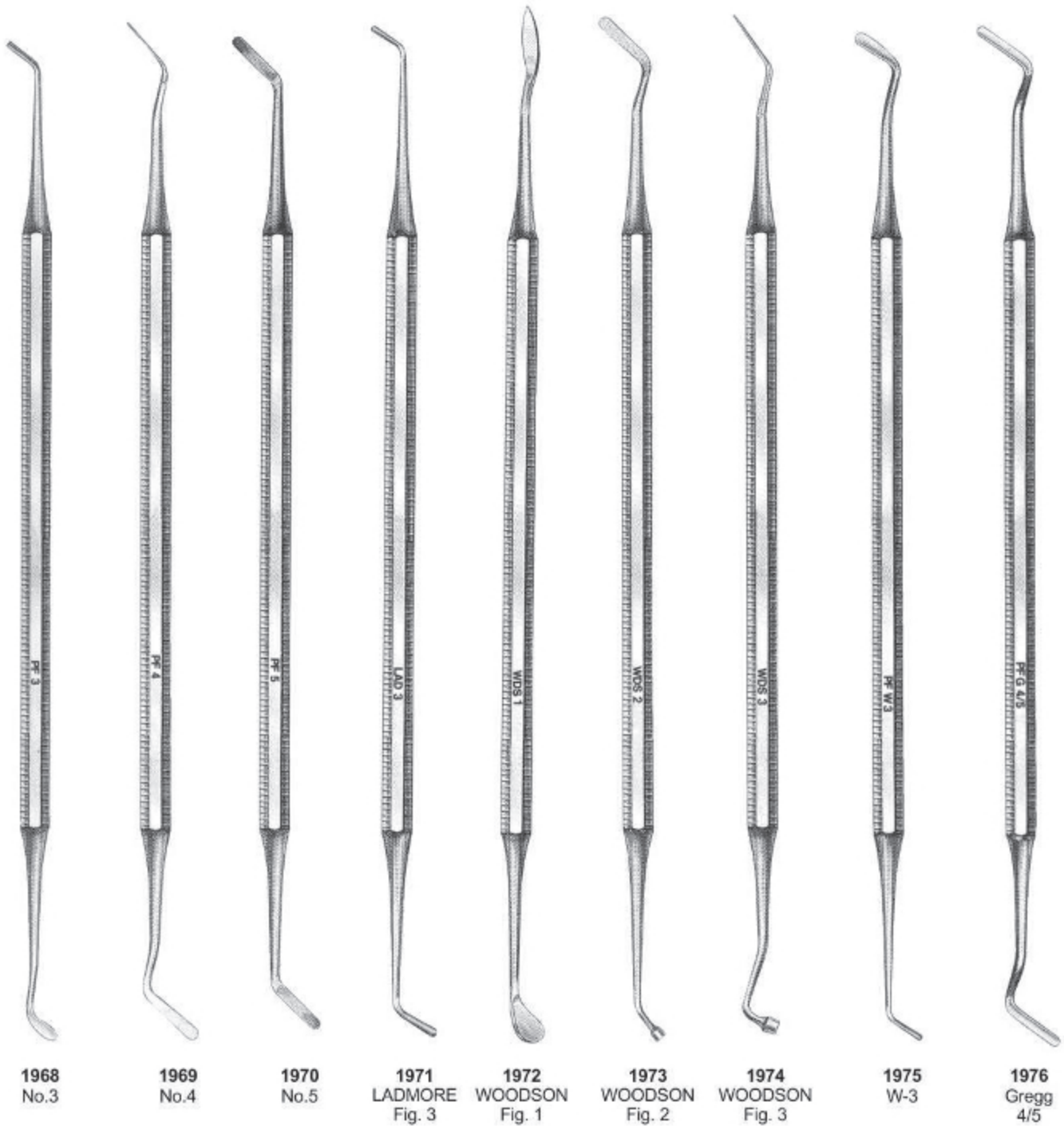

## Plastic Filling Instruments



1977  
Fig. 5-7



1978  
Fig.1



1979  
Fig. 3



1983  
GLICK  
Fig.1



1980  
Fig. 4



1984  
P8



1981  
Fig. 5-7



1985  
WOODSON  
Fig. 1



1982  
Fig. 8A



1986  
WOODSON  
Fig. 2



1987  
WOODSON  
Fig. 3



## Curettes



**1988**  
GRACEY  
GC 1-2



**1989**  
GRACEY  
GC 3-4



**1990**  
GRACEY  
GC 5-6



**1991**  
GRACEY  
GC 7-8



**1992**  
GRACEY  
GC 9-10



**1993**  
GRACEY  
GC 11-12



**1994**  
GRACEY  
GC 13-14

## Gracey Curettes



1995  
G1-2



1996  
G3-4



1997  
G5-6



1998  
G7-8

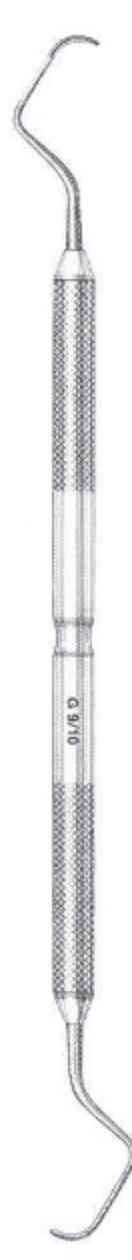

1999  
G9-10



2000  
G11-12



2001  
G13-14

## Curettes # 4 Handle

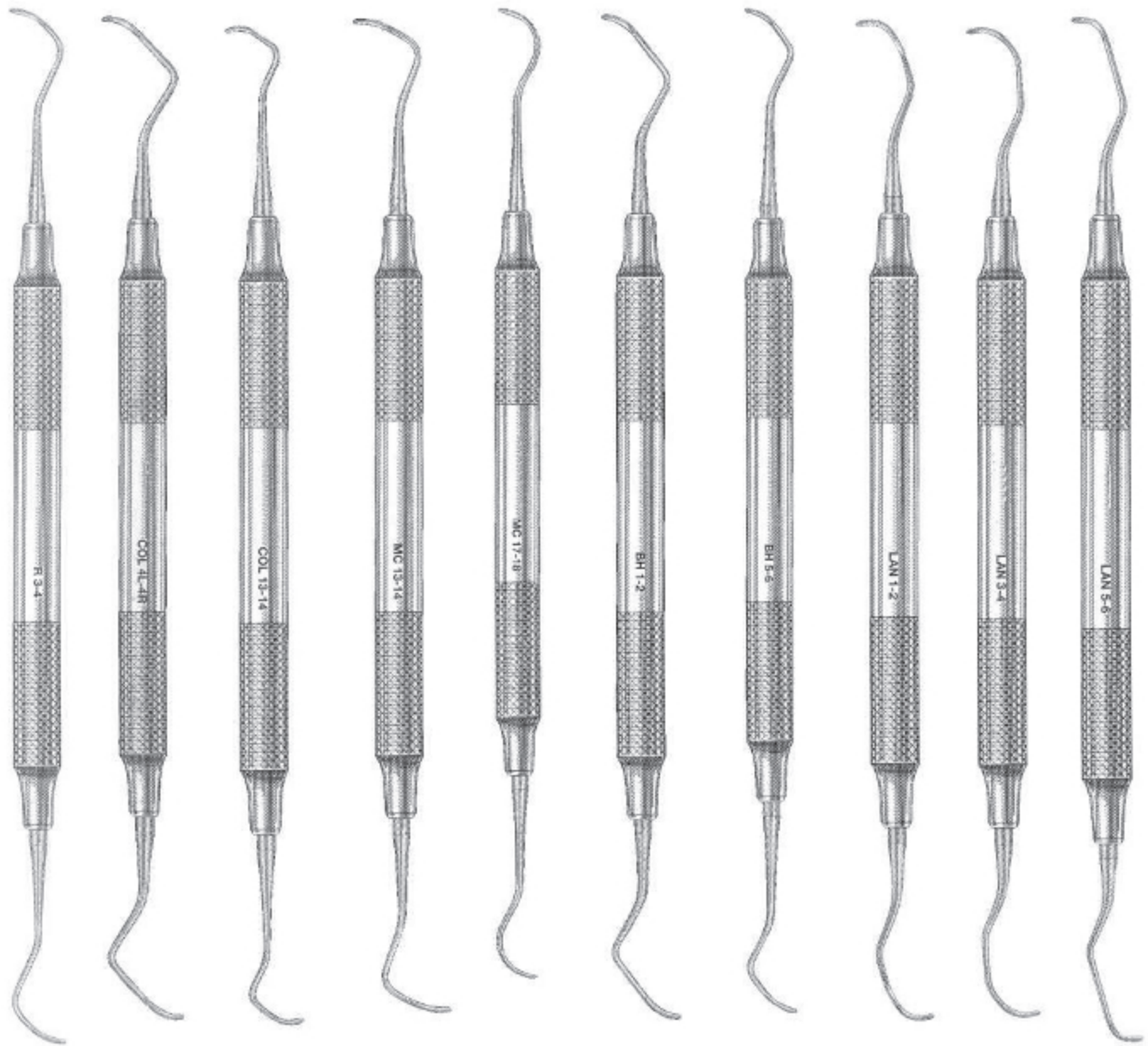

**2002**  
RULE  
3-4

**2003**  
COLUMBIA  
4R-4L

**2004**  
COLUMBIA  
13-14

**2005**  
MCCALLS  
13-14

**2006**  
MCCALLS  
17-18

**2007**  
BARNHART  
1-2

**2008**  
BARNHART  
5-6

**2009**  
LANGER  
1-2

**2010**  
LANGER  
3-4

**2011**  
LANGER  
5-6

## Curettes

### COLUMBIA CURETTES



2012  
4L-4R

2013  
13-14

2014  
2L-2R

### MCCALLS CURETTES



2015  
13-14

2016  
13S-14S

2017  
17-18

2018  
17S-18S

**Curettes**

**GOLDMAN FOX**



**2019**  
GF1 Universal Scaler



**2020**  
GF2 Curette



**2021**  
GF3 Curette



**2022**  
GF4 Curette



**2023**  
GF5 Hoe



**2024**  
GF6 Hoe

GOLDMAN FOX



2025  
GF 7 Knife



2026  
GF 8 Spear Knife



2027  
GF 9 Knife Scaler



2028  
GF 11 Spear Knife



2029  
GF 21 Sharp Spoon /  
Small Scaler



## Knives, Interproximal Files



**2030**  
Kirkland 15 / 16



**2031**  
Ordan 1 / 2



**2032**  
Buck 3 / 4



**2033**  
Buck 5 / 6



**2034**  
Goldman-Fox 7



**2035**  
Goldman-Fox 8



**2036**  
Goldman-Fox 9



**2037**  
Goldman-Fox 11



**2038**  
CK 3 (Crane)

## Interproximal Files



**2039**  
Sugarman 1S-2S

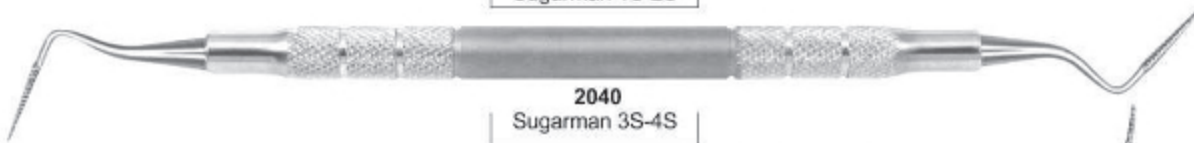

**2040**  
Sugarman 3S-4S



**2041**  
Schluger 9 -10



**2042**  
Buck 11 - 12

## Curettes, Root Planing Curettes



**2043**  
COLUMBIA (2L-2R)



**2044**  
MCCALL (13-14)



**2045**  
MCCALL (17S-18S)

### Root Planing Curettes



**2046**  
Root Plane (1-2)



**2047**  
Root Plane (5-6)



**2049**  
Root Plane (11-12)



**2048**  
Root Plane (7-8)



**2050**  
Root Plane (13-14)



**2051**  
Petite (1-2)



**2052**  
Petite (11-12)



**2053**  
Petite (5-6)



**2054**  
Petite (13-14)

## Curettes



**2055**  
BARNHART (1-2)



**2056**  
BARNHART (5-6)



**2065**  
COLUMBIA (4L-4R)



**2057**  
GRACEY (1-2)



**2066**  
COLUMBIA (13-14)



**2058**  
GRACEY (3-4)



**2067**  
LANGER (1-2)



**2059**  
GRACEY (5-6)



**2068**  
LANGER (3-4)



**2060**  
GRACEY (7-8)



**2069**  
LANGER (5-6)



**2061**  
GRACEY (9-10)



**2070**  
MCCALL (13-14)



**2062**  
GRACEY (11-12)



**2071**  
MCCALL (13S-14S)



**2063**  
GRACEY (13-14)



**2072**  
MCCALL (17-18)



**2064**  
GRACEY (2L-2R)



**2073**  
MCCALL (17S-18S)



**2074**  
RULE (3-4)



## Dental Products

Silicon Handles-Reusable

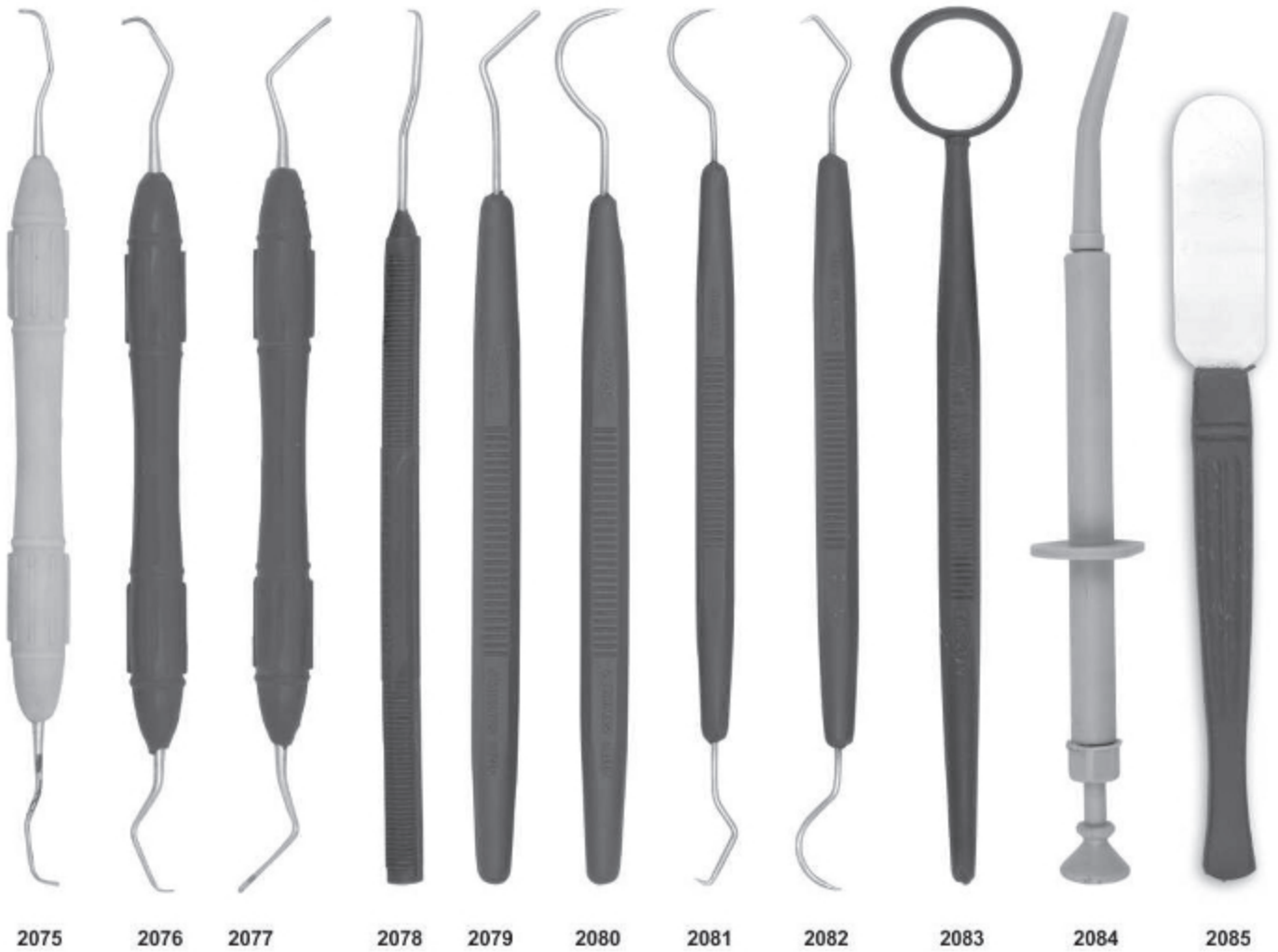

# SECTION 04



- ▶ Cement Instruments
- ▶ Spatulas
- ▶ Knives
- ▶ Bone Currettes & Files
- ▶ Bone Chisels
- ▶ Bone Mallets
- ▶ Crown Remover
- ▶ Implant Instruments



Comfort Grip  
Vinyl - Covered Insulating Handles



## Wax, Porcelain & Cement Instruments

### P.K. THOMAS

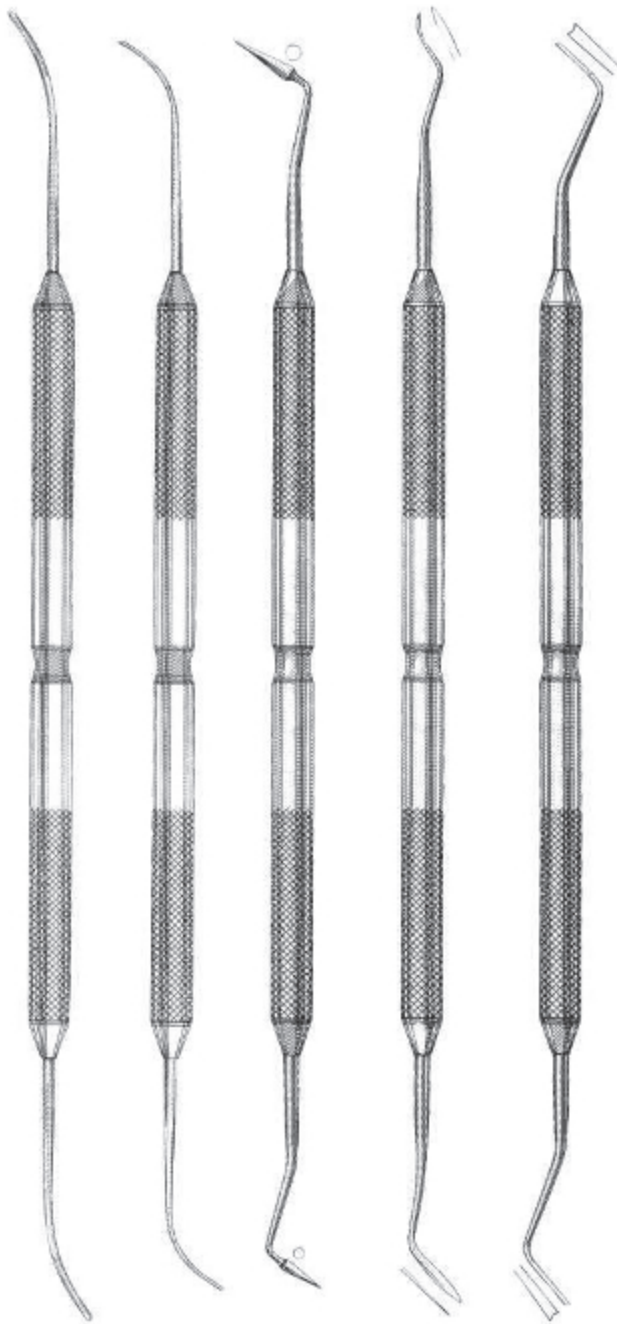

2101 PKT 1    2102 PKT 2    2103 PKT 3    2104 PKT 4    2105 PKT 5

Set of 5 instruments

### WAX CARVERS

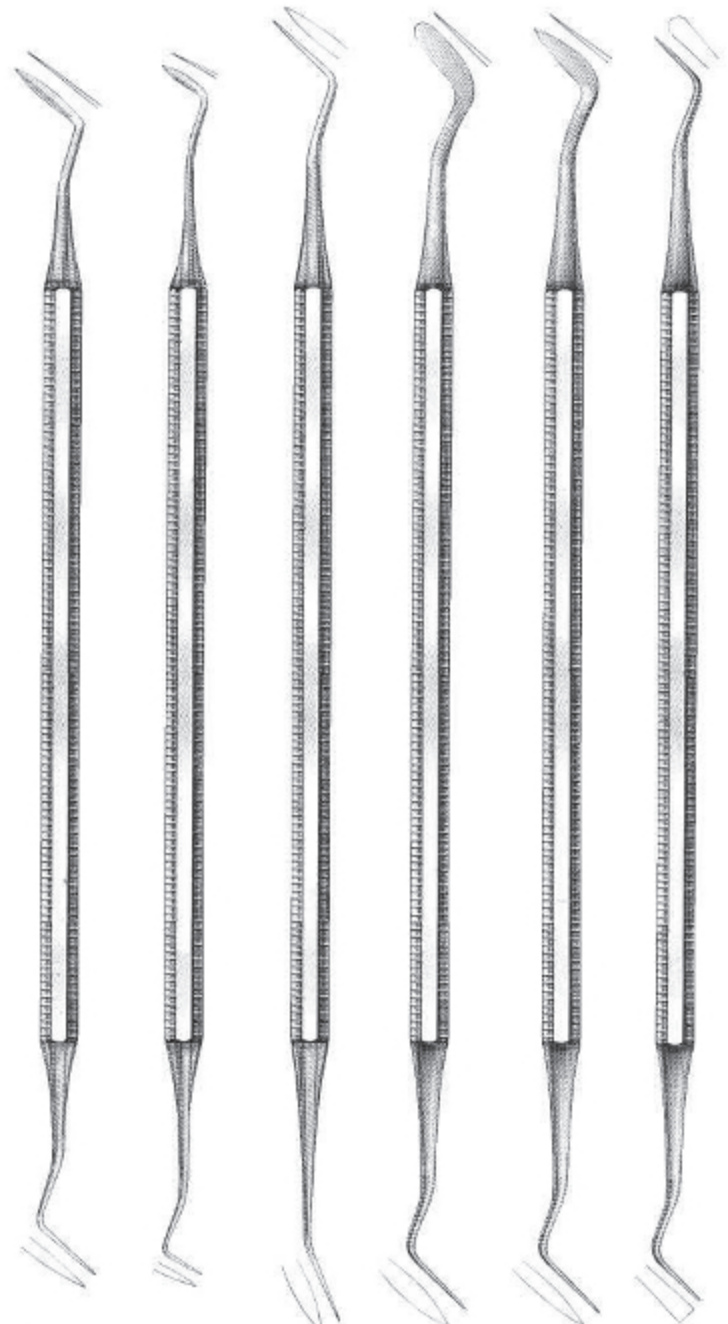

2106 Hollenback 3    2107 Hollenback 3S    2108 WARD 1    2109 WARD 2    2110 WALL 1    2111 WALL 3

## Wax & Modelling Carvers, Cement Spatulas

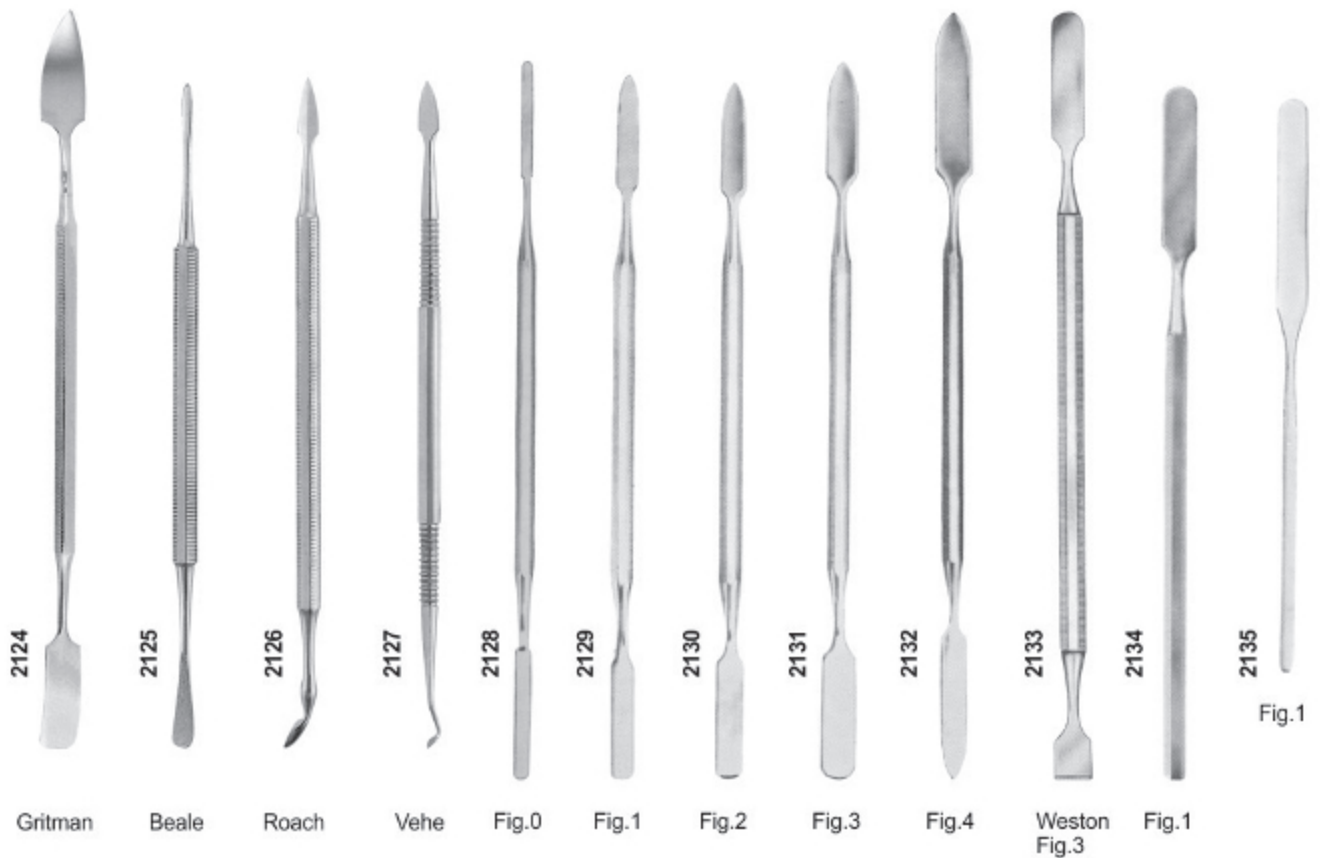
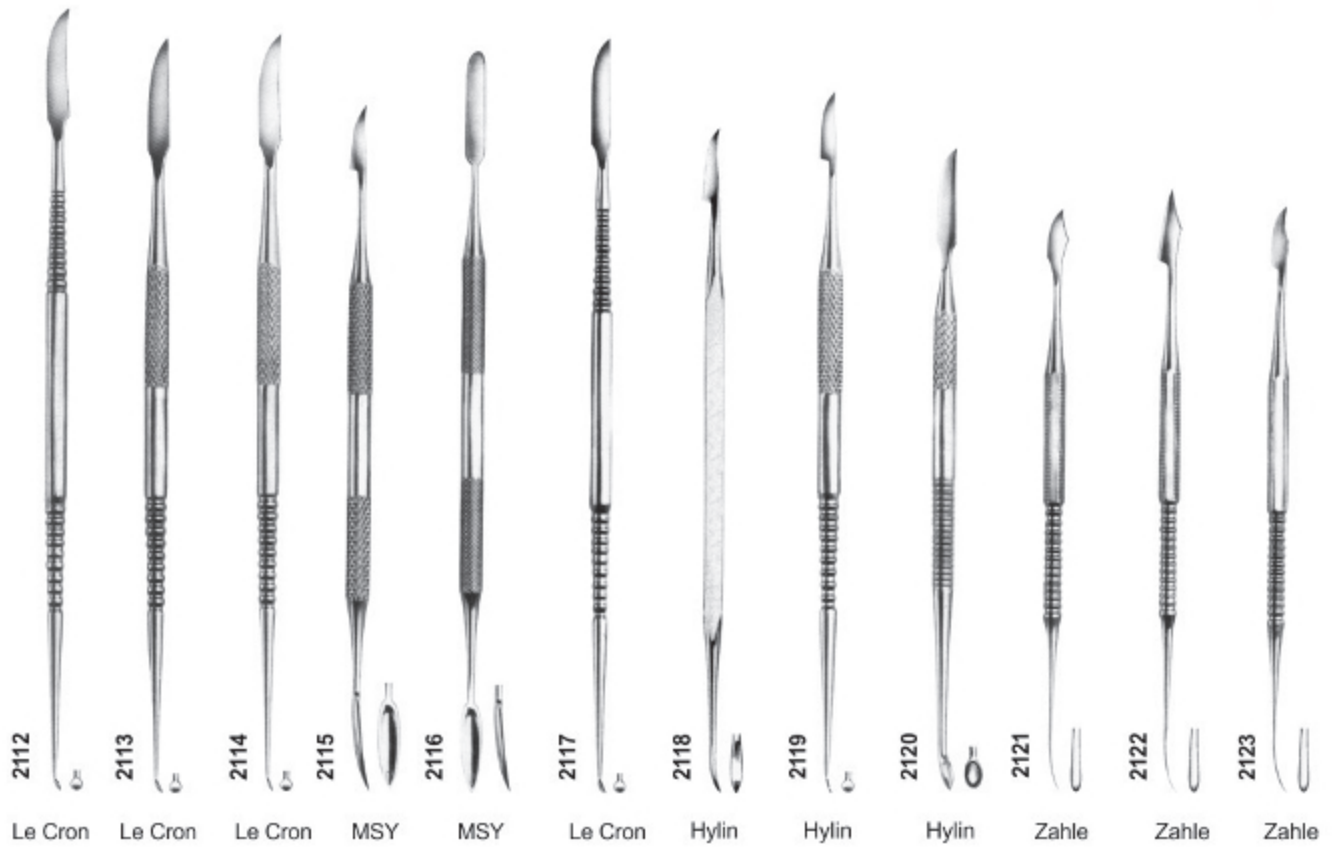



## Wax, Porcelain & Cement Instruments

### WAX & PORCELAINE CARVERS



2136  
LECRON  
Inlay

2137  
REEVES

2138  
VEHE  
Wax

2139  
ROACH  
Wax

### WAX SPATULAS

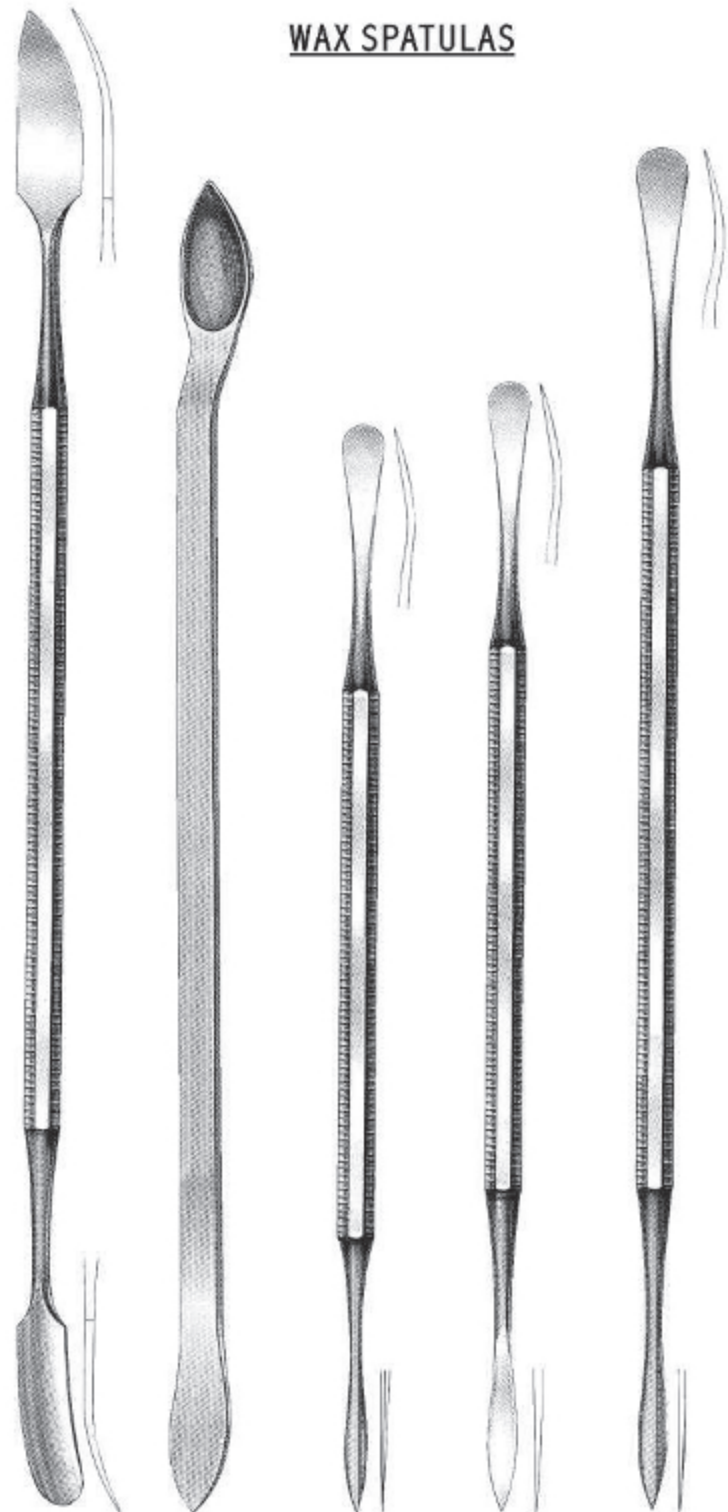

2140  
W-31

2141  
W-5

2142  
W-7

2143  
W-7A

2144  
W-7G

## Cement Spatulas



2145  
AGATHE



2146  
C-7



2147  
C-5



2148  
C-313



2149  
C-24A Rigid



2150  
C-24 Flexible



2151  
C-24 Flexible



2152  
24



2153  
A6



2154  
7 Wax



2155  
26



2156  
All Metal Spatulas with High Polish  
Stainless Steel Blade



2157  
31

## Spatulas

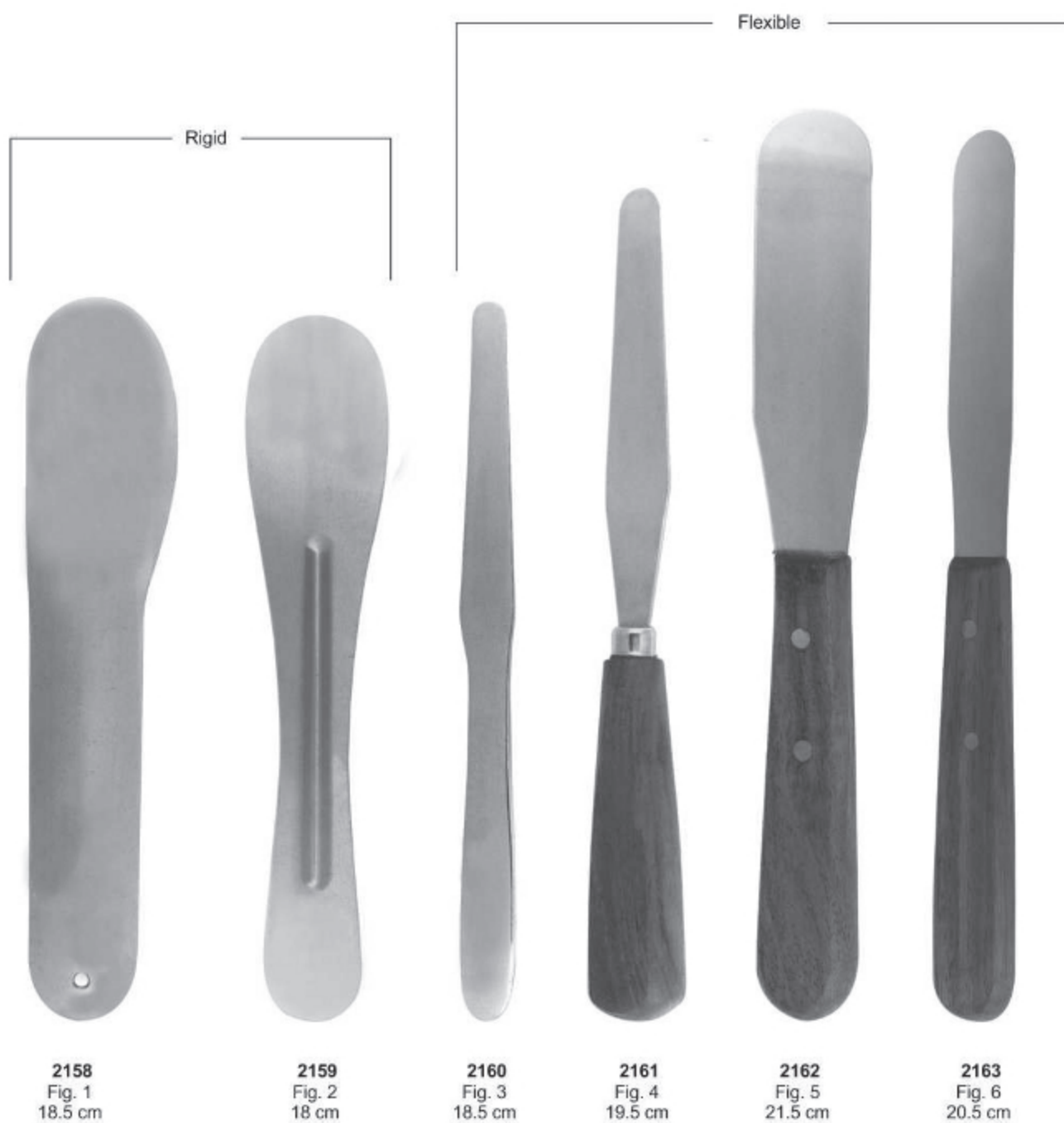

## Spatulas



## Files, Hoes & Knives

### FILES



### HOES

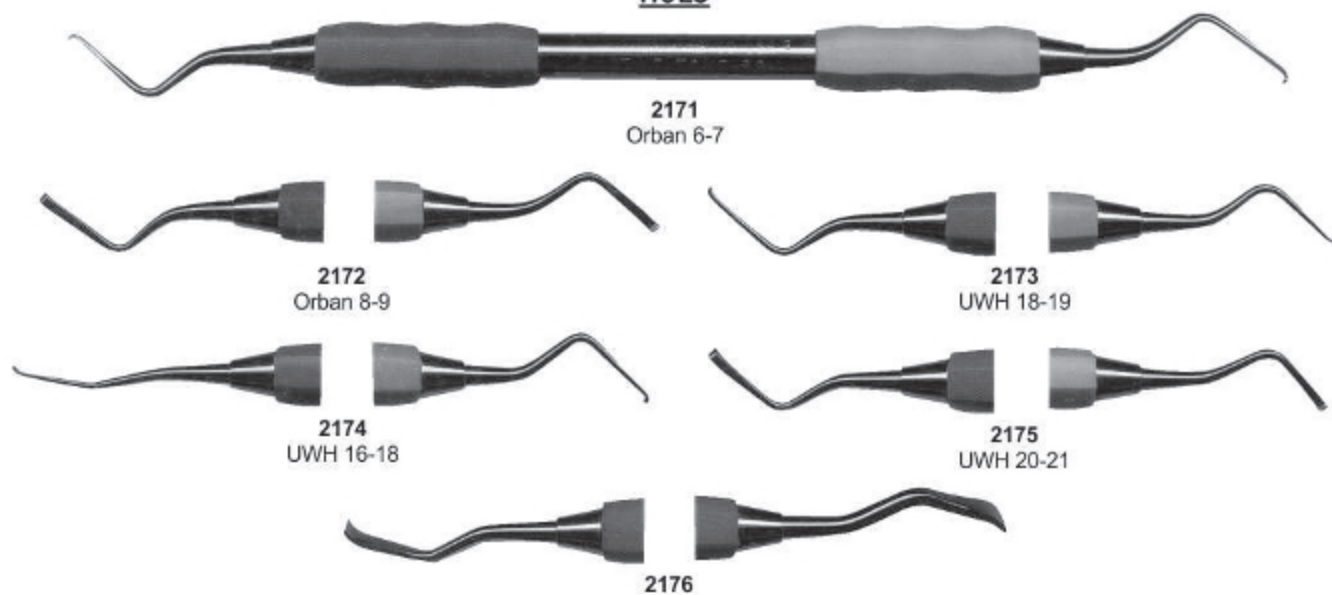

### KNIVES

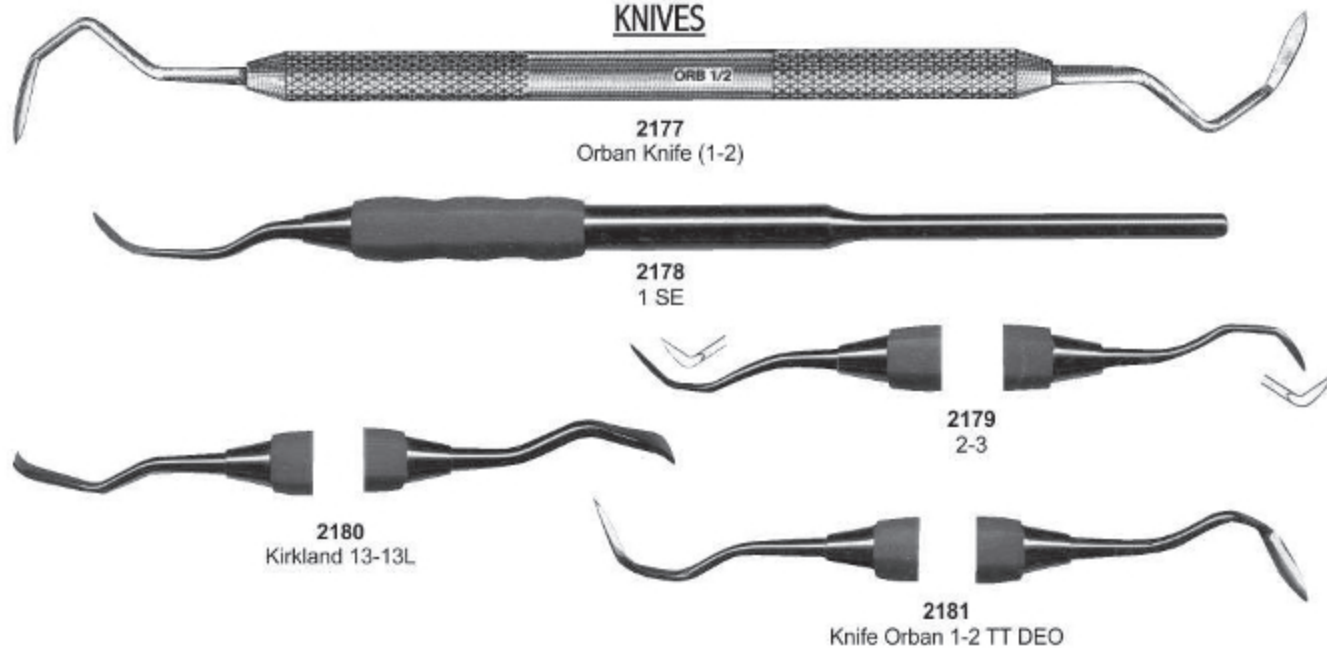

## Wax Knives



**2182**  
Fahnenstock  
Fig. 1  
12,5cm



**2183**  
Fahnenstock  
Fig. 2  
17cm



**2184**  
Lessmann  
Fig. 1  
12,5cm



**2185**  
Lessmann  
Fig. 2  
17cm



**2186**  
Con scodellino  
Fig. 1  
12,5cm



**2187**  
Con scodellino  
Fig. 2  
17cm



**2188**  
Ermert



**2189**  
Ermert

## Wax Knives & Plaster Knives



**2190**  
18 cm  
7 1/8"



**2191**  
18 cm  
7 1/8"



**2192**  
17 cm  
6 3/4"  
Gritman



**2193**  
17 cm  
6 3/4"  
Medicon



**2194**  
Fig. 1  
17 cm



**2195**  
22 cm  
8 3/4"



**2196**  
22 cm  
8 3/4"



**2197**  
Gritman  
Fig. 2  
17 cm



**2198**  
Fig. 3  
16 cm



**2199**  
Fig. 4  
16 cm

## Crane-Kaplan, Chisels

### CRANE-KAPLAN



**2200**  
Ck1  
Pocket Marker

**2201**  
Ck2  
Pocket Marker

**2202**  
Knife

**2203**  
Dissector

**2204**  
Scaler

### OCHSENBEIN



**2205**  
Ochsenbein  
Fig. 1

**2206**  
Ochsenbein  
Fig. 2

**2207**  
Ochsenbein  
Fig. 4

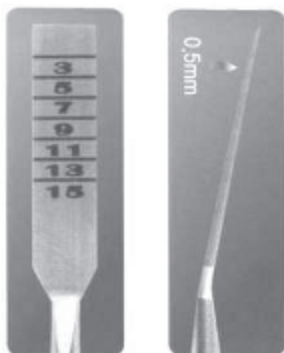

Split Chisel Set



**2208**  
Split Chisel  
6 mm Curved



**2209**  
Split Chisel  
6 mm Straight



**2210**  
Split Chisel  
4 mm Curved



**2211**  
Split Chisel  
4 mm Straight



## Bone Currettes

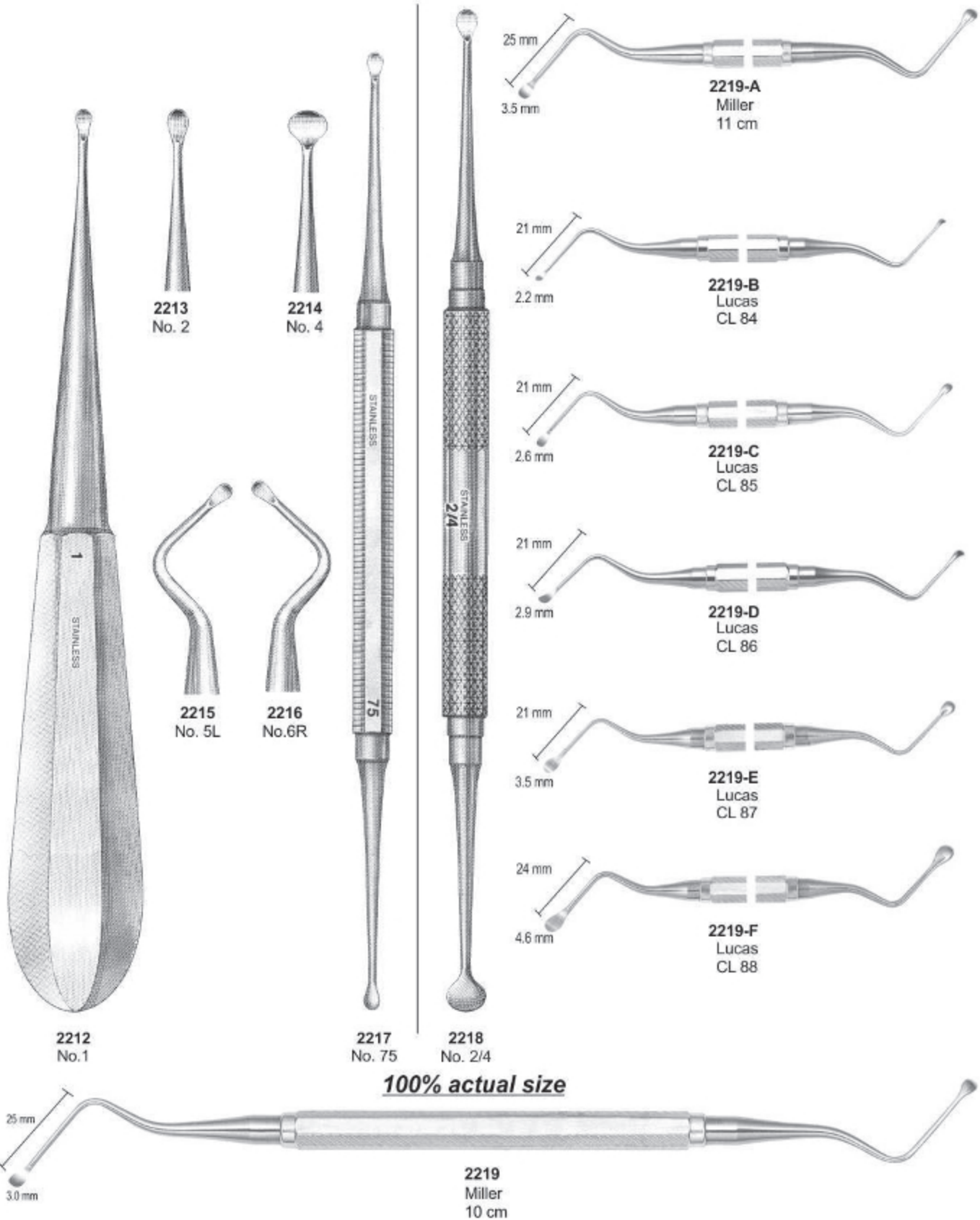

## Bone Files

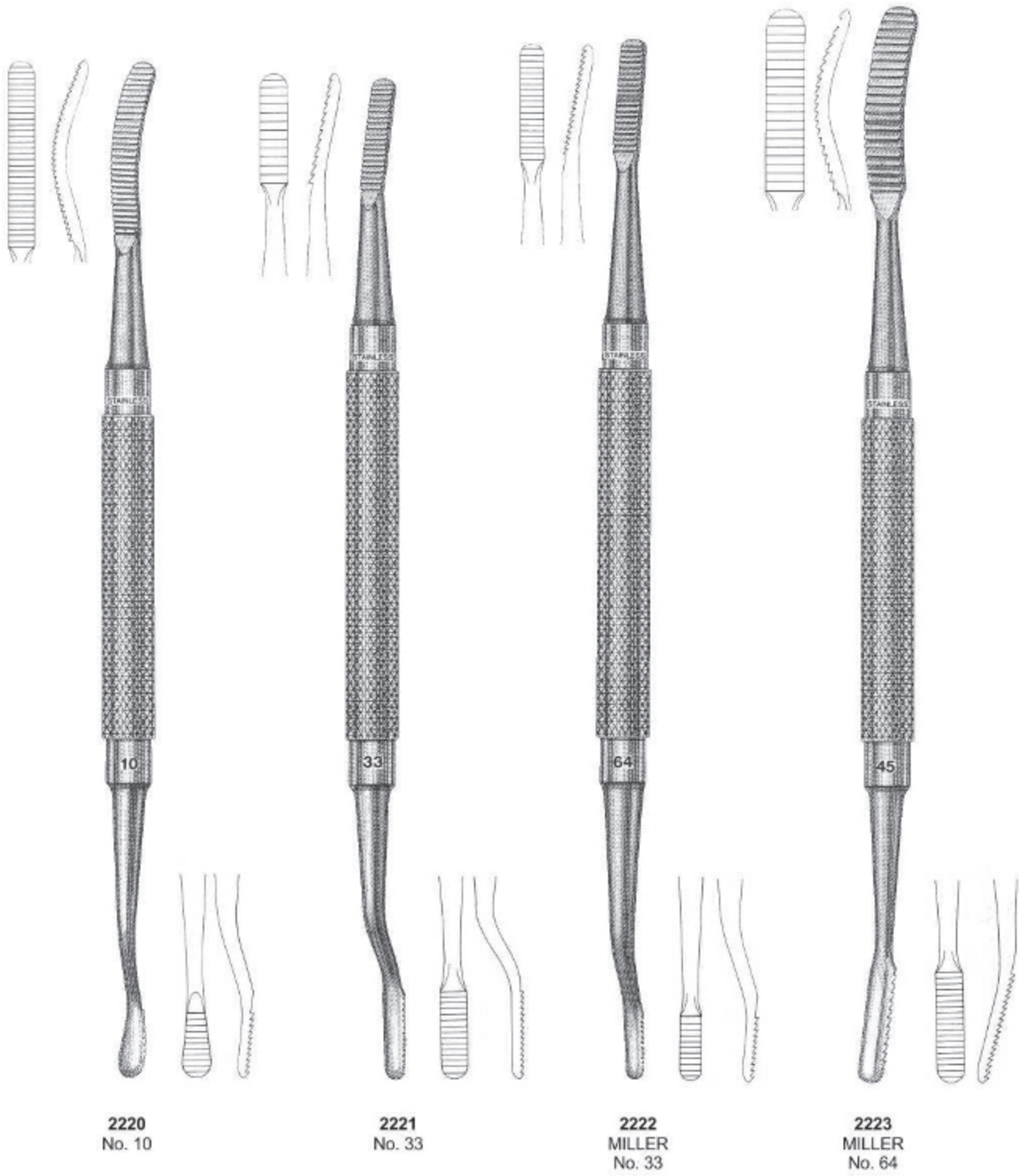

## Bone Files

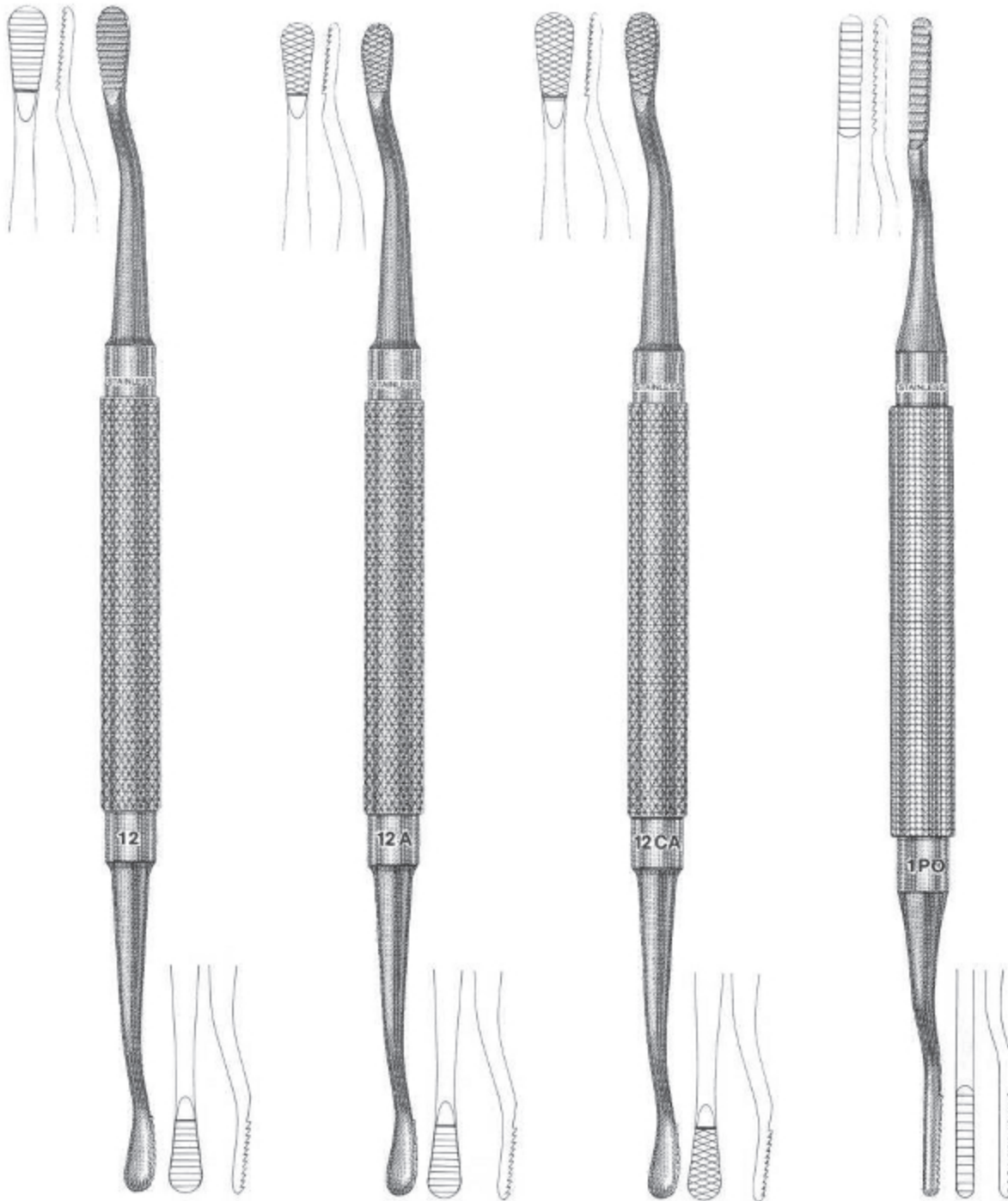

**2224**  
HOWARD  
No. 12

**2225**  
HOWARD  
No. 12A

**2226**  
HOWARD  
No. 12CA

**2227**  
POLOKOFF  
No. 1

## Bone Chisels

### GARDNER

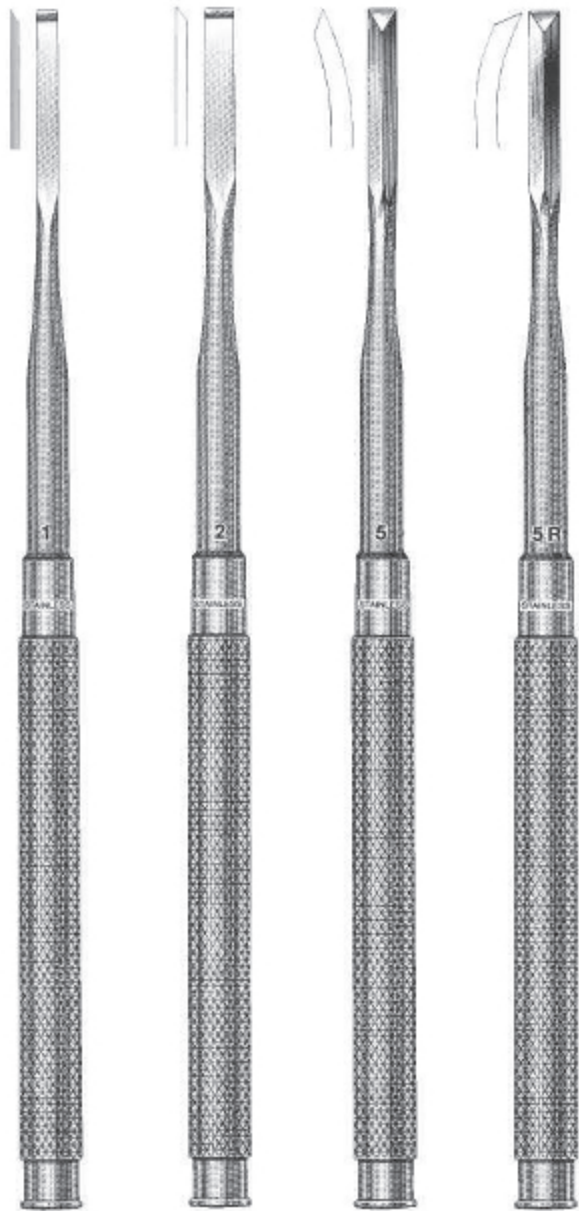

2228  
GARDNER  
No. 1

2229  
GARDNER  
No. 2

2230  
GARDNER  
No. 5

2231  
GARDNER  
No. 5R

### WAKEFIELD



2232  
WAKEFIELD  
No. 1W

2233  
WAKEFIELD  
No. 2W

## Bone Chisels, Bone Mallets

### Bone Chisels and Gouges

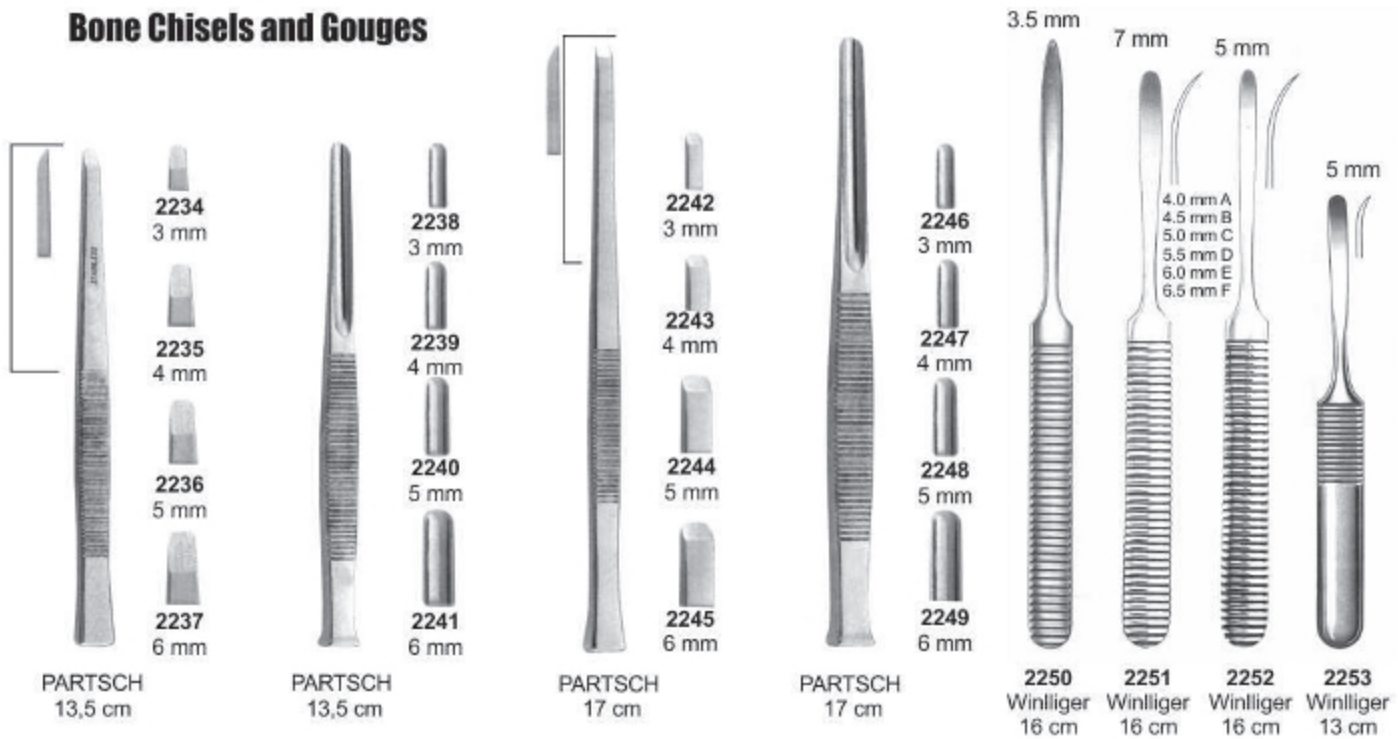

### Martelli chirurgici Mallet

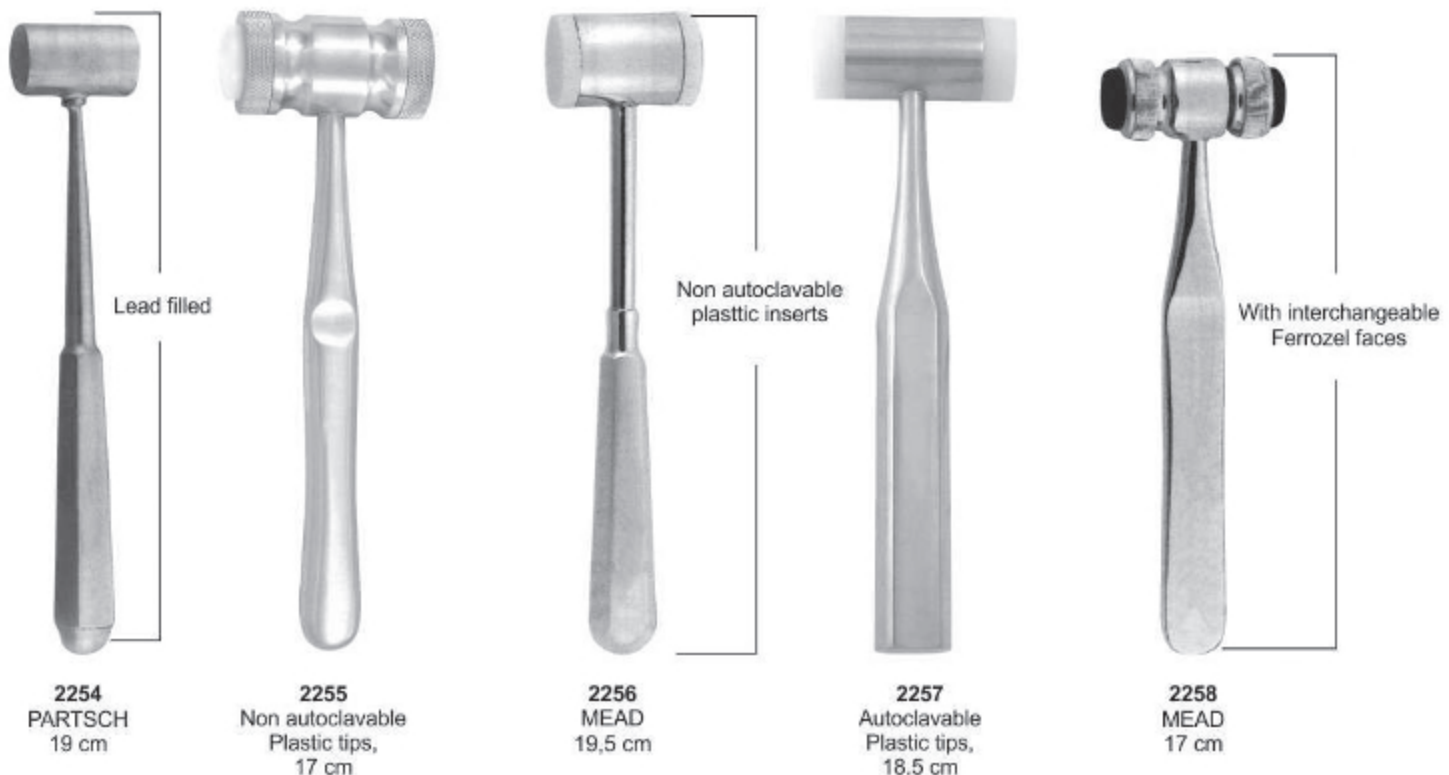

## Crown Remover

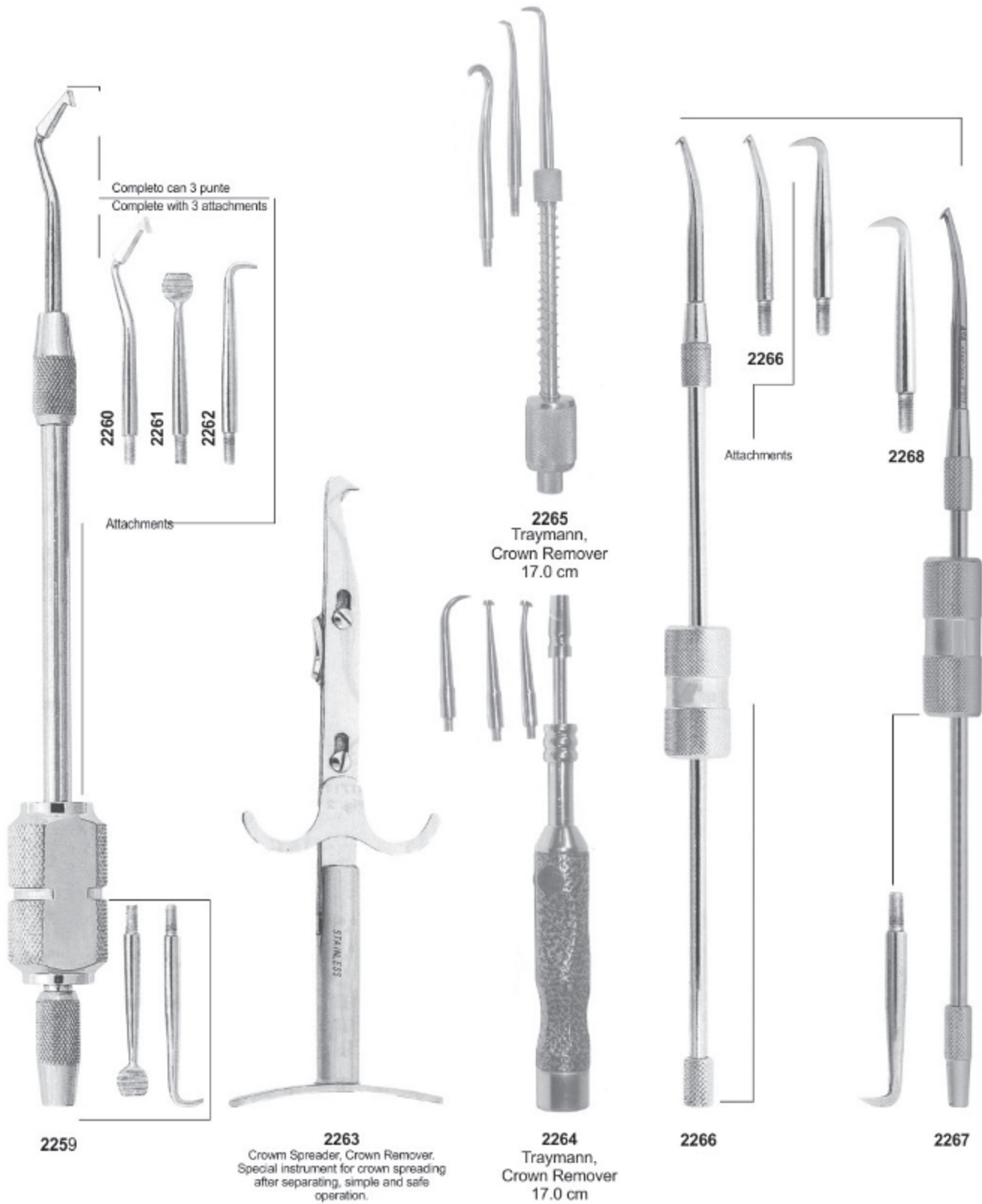

## Crown Instruments



## Crown Instruments



**2282**  
Plaster Shear  
210 mm



**2283**  
Crown Removing Plier  
14 cm



**2284**  
MONTFORT  
18 CM



**2285**  
BOHM  
16 cm



**2286**  
Telescope Crown  
Plier, Diamond coated  
13.0 cm



**2287**  
Telescope Crown  
Plier, Diamond coated  
13.0 cm



**2288**  
Telescope Crown Plier  
13.0 cm gerieften Maul  
15.0 cm gerieften Maul  
13.0 cm gelatts Maul  
15.0 cm gelatts Maul



**2289**  
Telescope Crown  
Plier, Fine  
15.0 cm



## Implant Instruments

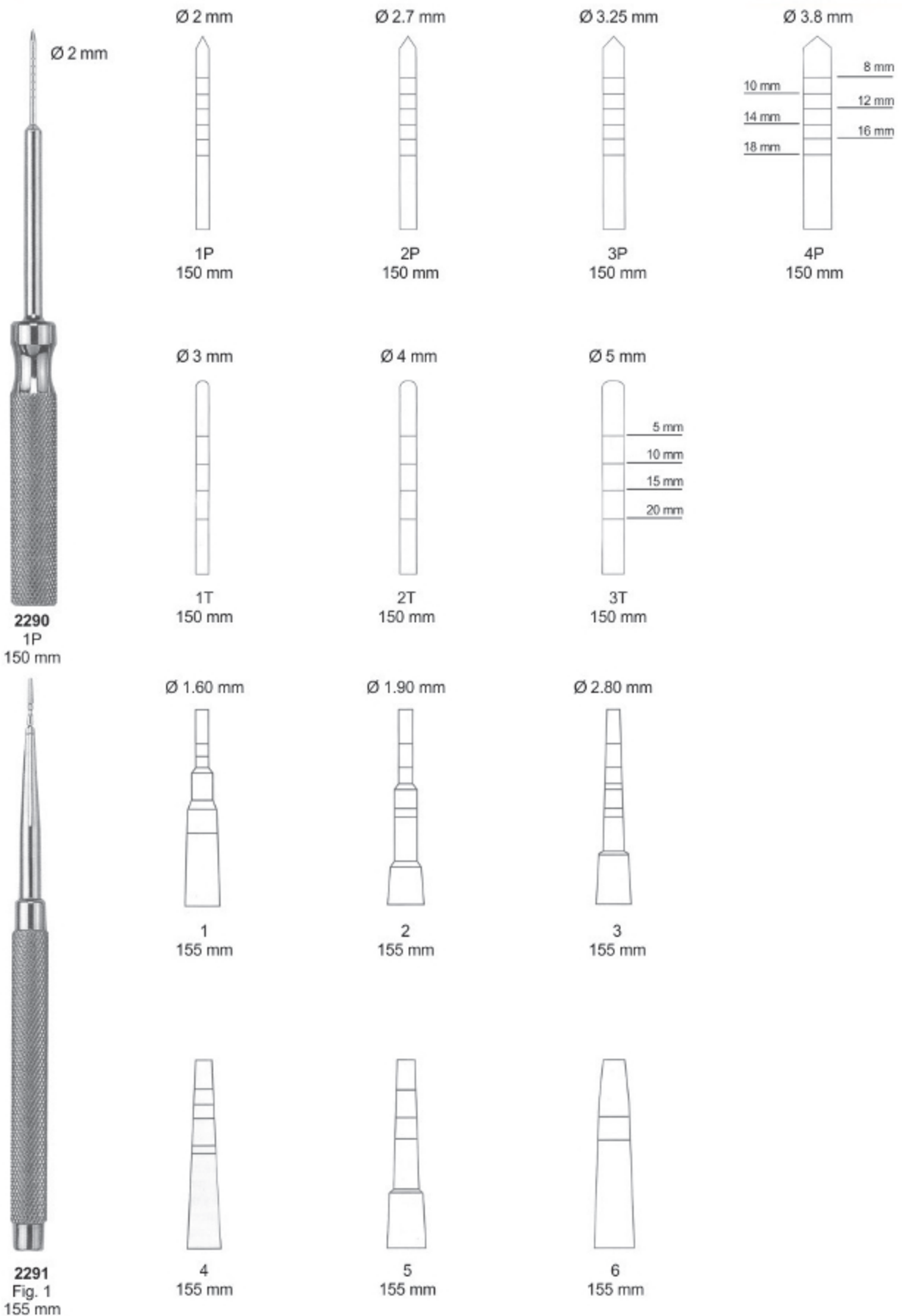

## Implant Instruments



**2292**  
Fig. 1B  
165 mm

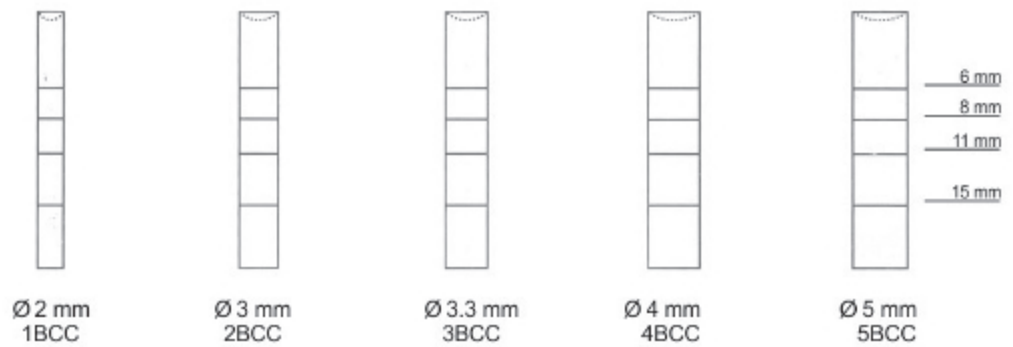
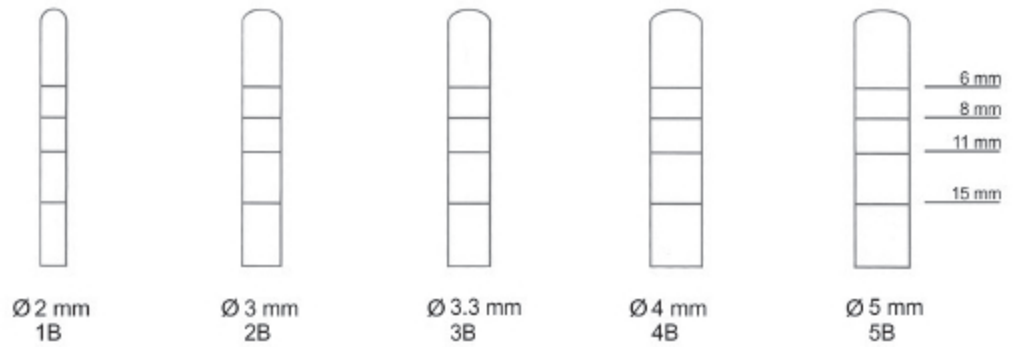

**2293**  
Fig. 1  
155 mm

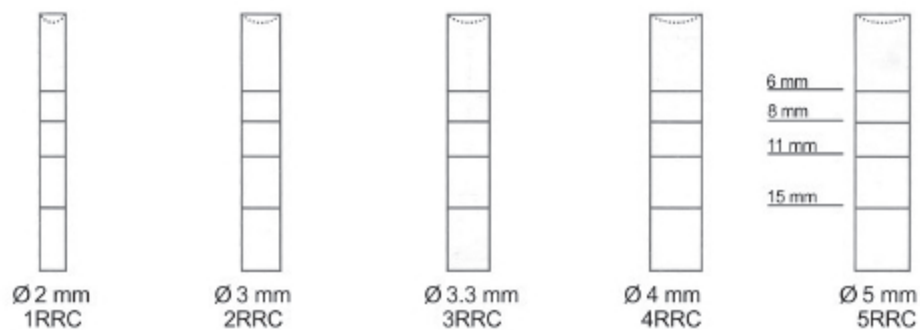
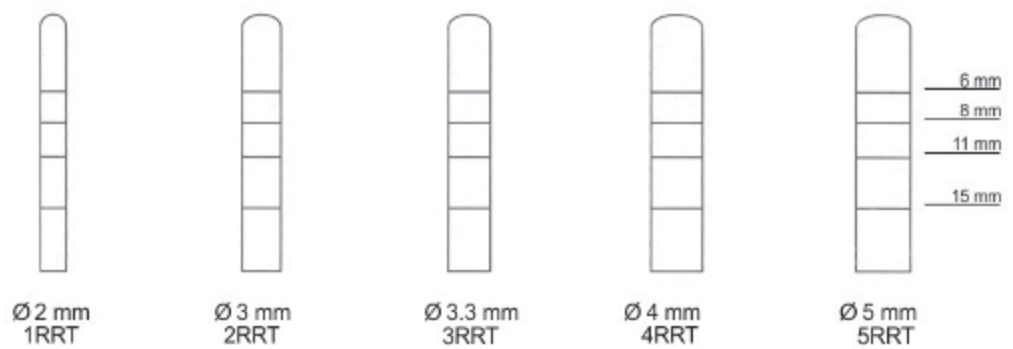

## Implant Instruments

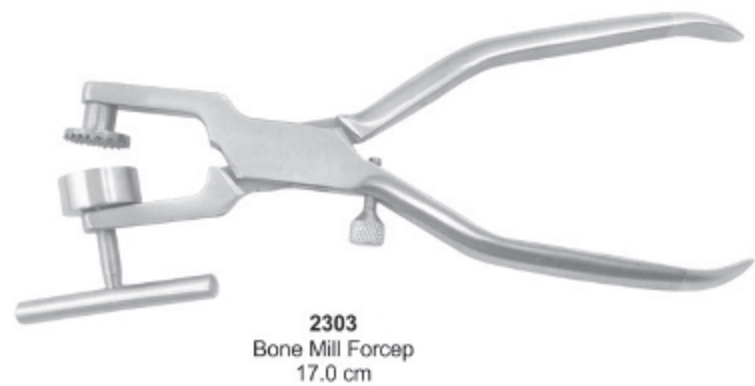
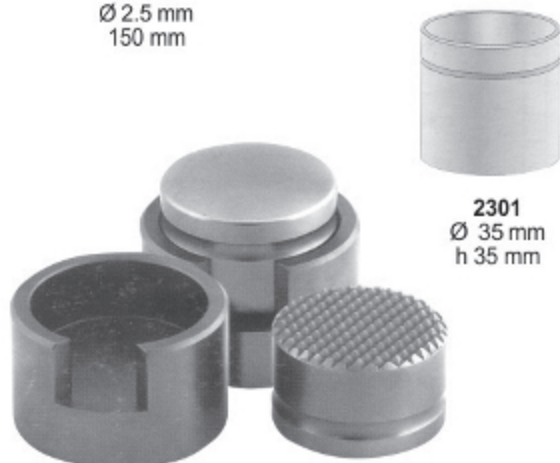
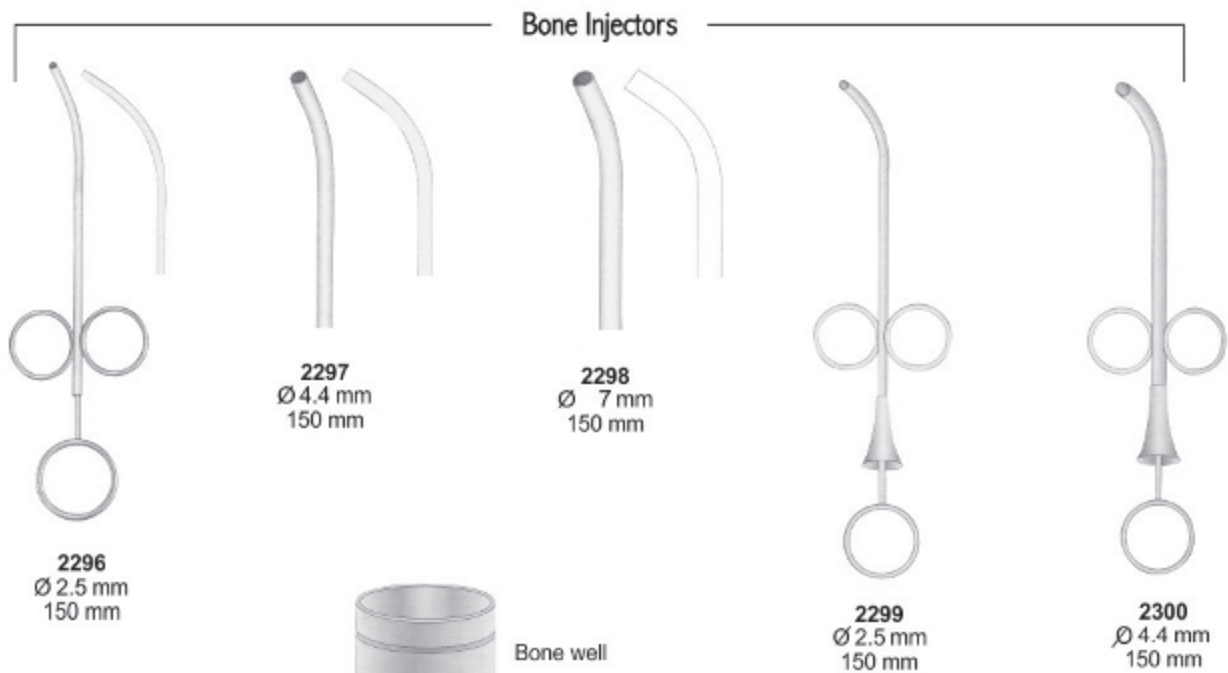
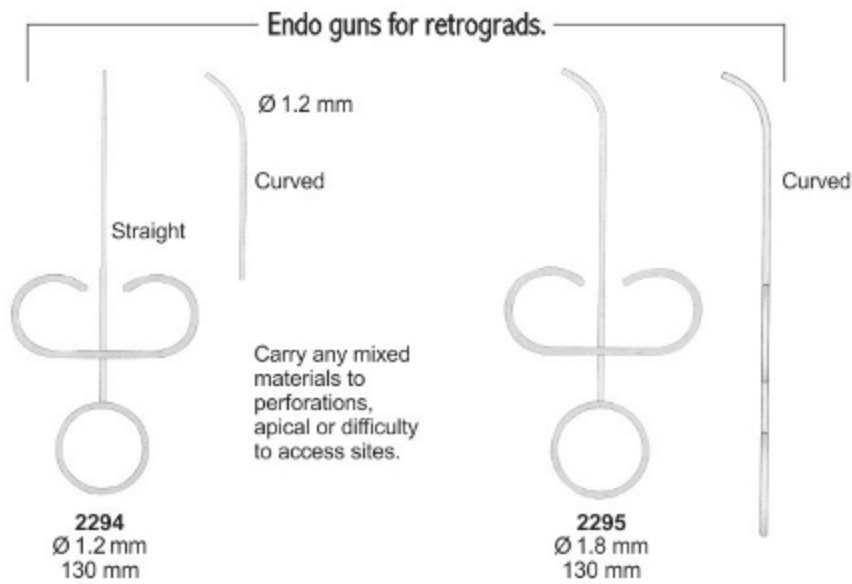

## Suction Tubes, bone Pluggers & Rongeurs

### Suction Tubes



### Bone Pluggers



### Kerrison Rongeurs



( 1.5 mm inside ) 2311  
 ( 2.0 mm inside ) 2312  
 ( 3.0 mm inside ) 2313  
 ( 4.0 mm inside ) 2314  
 ( 4.5 mm inside ) 2315  
**16.5 cm**



# SECTION 05



- ▶ Measuring Instruments
- ▶ Amalgam Guns & Carriers
- ▶ Retainers
- ▶ Rubber Dam Instruments
- ▶ Dental Syringes
- ▶ Tweezers
- ▶ Sterilizing & Lab. Instruments



## Implant Instruments



**2319**  
Fig. 1  
170 mm

**2320**  
Fig. 2  
175 mm

**2321**  
Fig. 3  
170 mm

**2322**  
LUCAS  
Fig. 88  
170 mm



Bone Compactors.

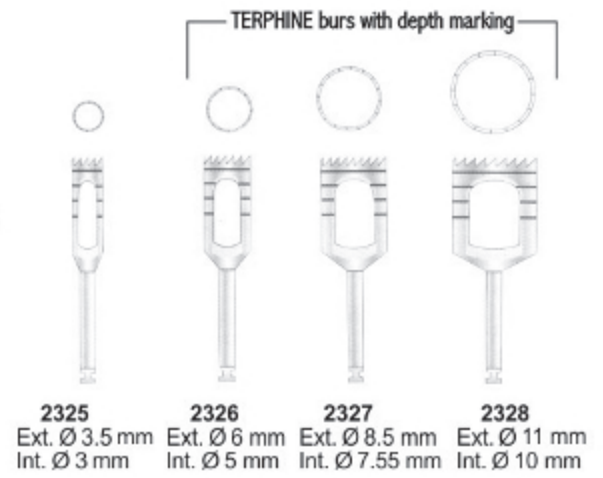

## Sinus lift instruments



**2329**  
Fig.1

**2330**  
Fig.2

**2331**  
Fig.3

**2332**  
Fig.4

**2333**  
Fig.5

**2334**  
Fig.6

**2335**  
Fig.7

**2336**  
Fig.8

**2337**  
Fig.9

## Suction Tubes

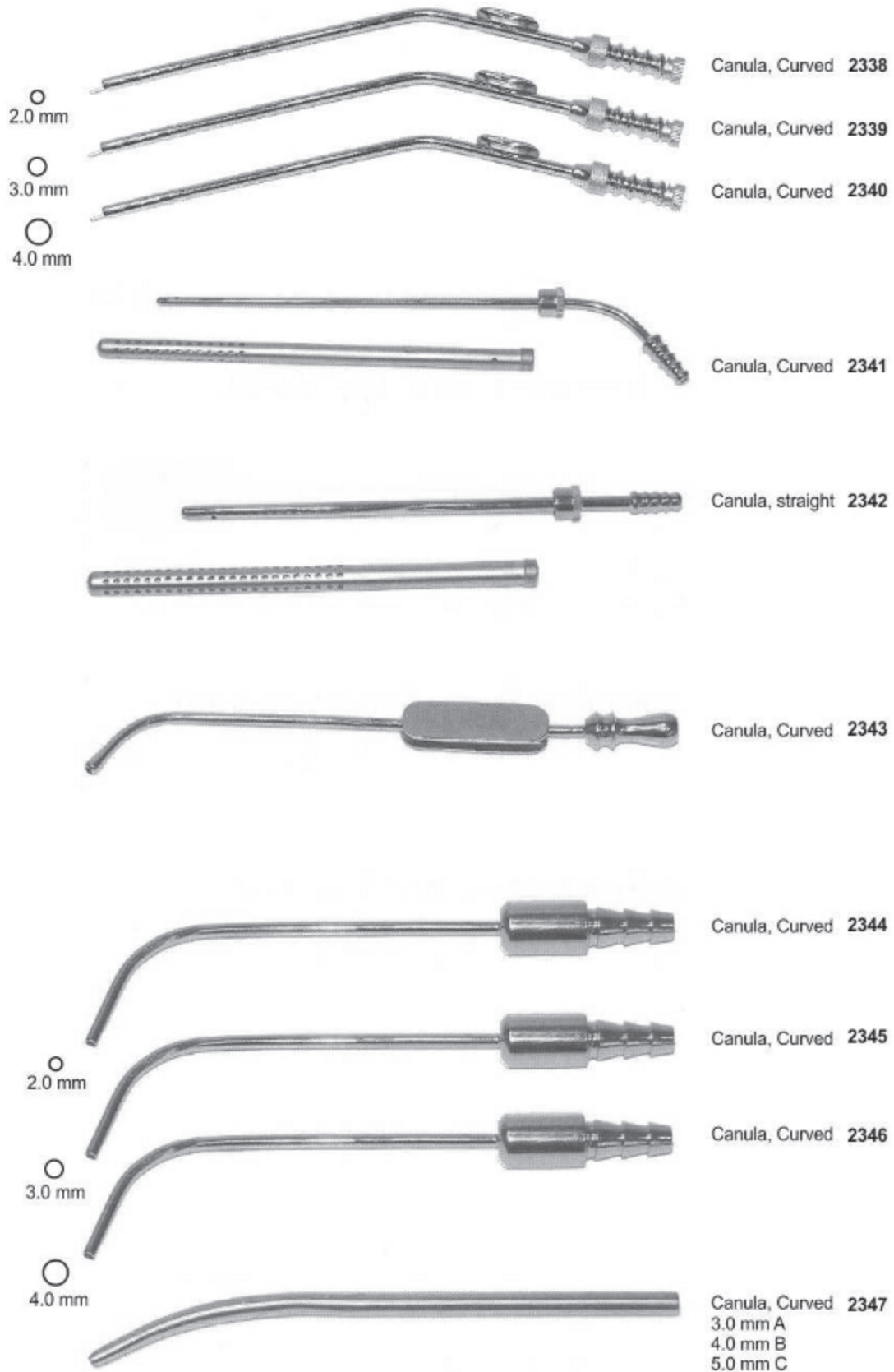

## Measuring Instruments



**2348**  
BOLEY Gauge



**2349**  
ZURICHER  
130 mm



**2350**  
VERNIER  
12 cm



**2351**  
VERNIER



**2352**  
VERNIER Gauge



**2353**  
VERNIER Gauge



**2355**  
Finger Ruler



**2354**  
LWANSON  
Crown Gauge



**2356**  
LWANSON  
Crown Gauge



**2357**  
Sliding Gauge  
10 cm



**2358**  
Spring Bow Divider  
6" Radius



**2359**  
VERNIER  
Gauge



**2360**  
ALBEE



**2361**  
Height Gauge  
Wick Type



## Bone Gauge & Measuring Instruments



**2362**  
Bone Gauge



**2363**  
Bone Caliper  
15 cm



**2364**  
Castroviejo



**2365 A**  
Castroviejo  
Curved

**2365 B**  
Straight



**2366 C**  
Castroviejo  
Straight

**2366 D**  
Curved



**2367**  
Gauge

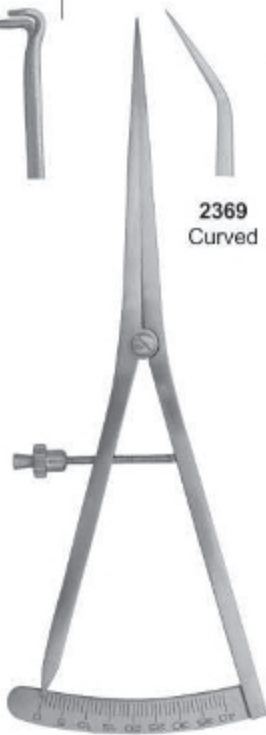

**2368**  
Castroviejo  
Straight

**2369**  
Curved



**2370**  
Castroviejo  
Straight

**2371**  
Curved



**2373**  
Boone - Gauge



**2372**  
Castroviejo

**2374** **2375**  
Curved Straight



**2376**  
Bracket Gauge. Ant/Post



## Amalgam Guns & Carriers

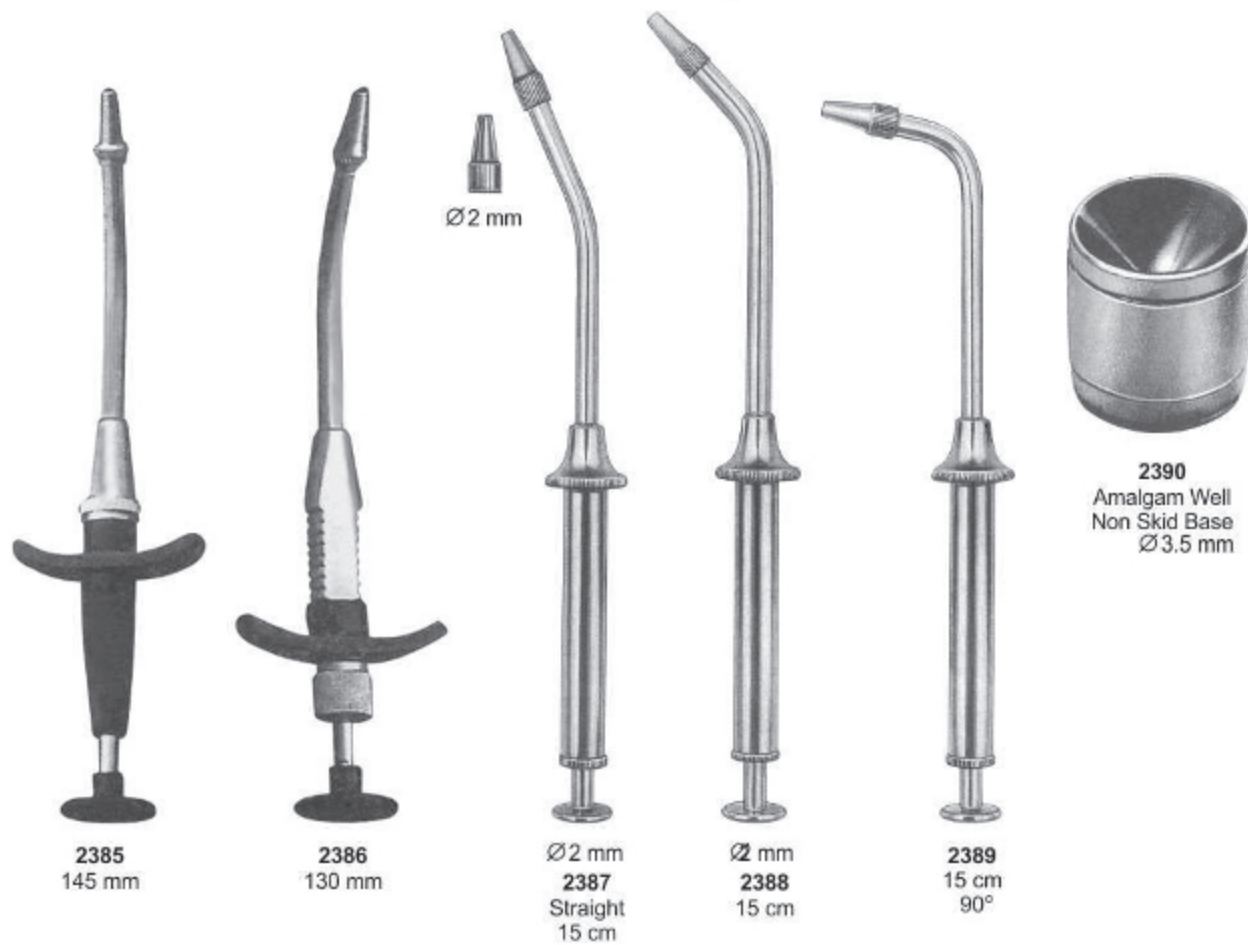
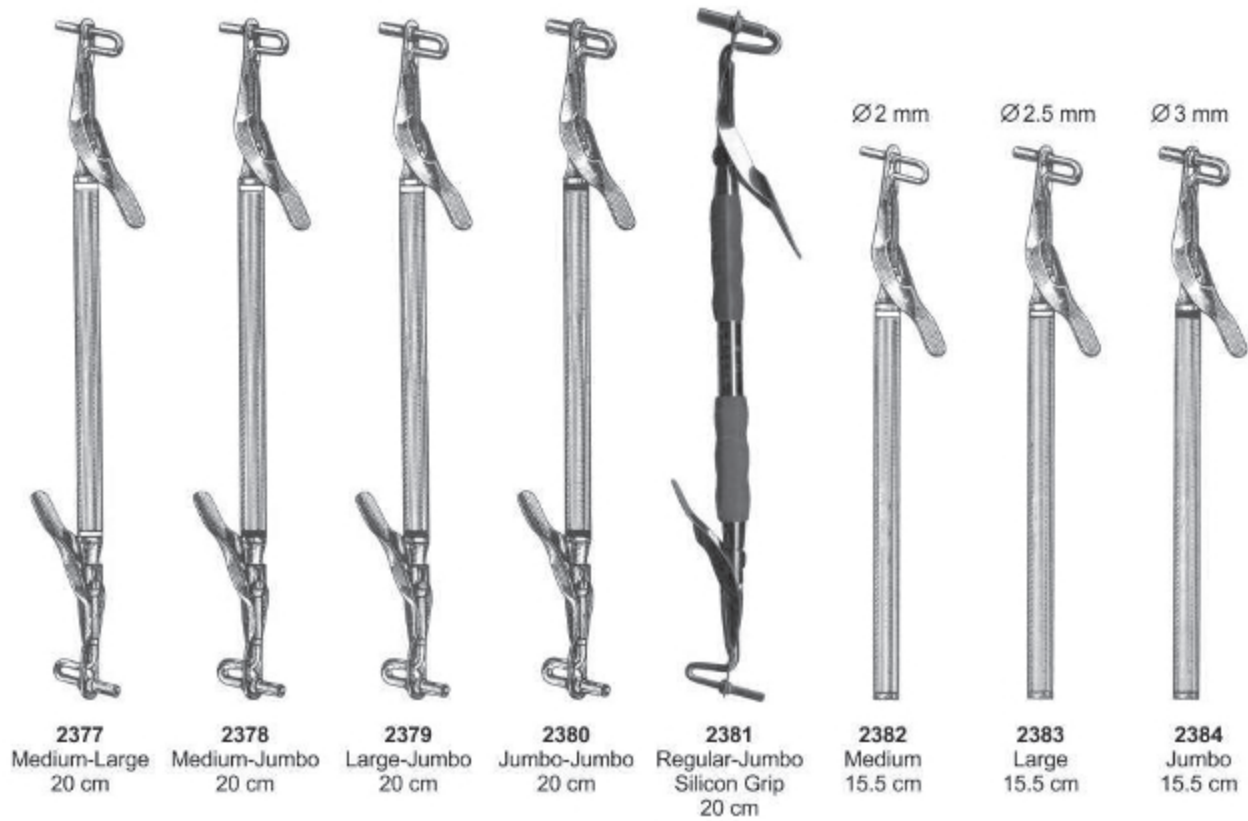

## Retainers, Bands, Strip Holder Clips, Napkin Holders

### Retainers

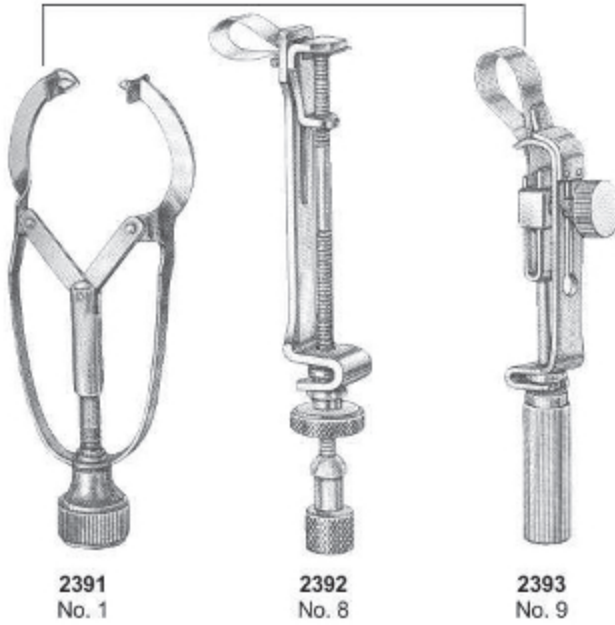

### "Tofflemire" Type Retainers



### Tofflemire Bands

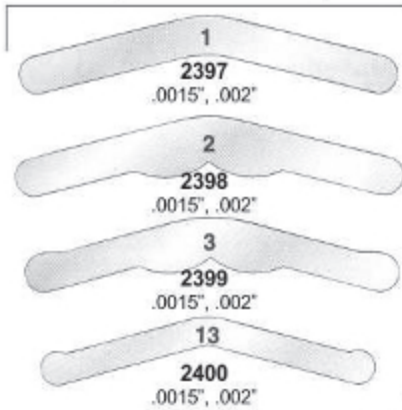

2401  
X-Ray Holder  
Small



Set of 10  
2402  
Film Hanger

### Napkin Holders



### Strip Holders

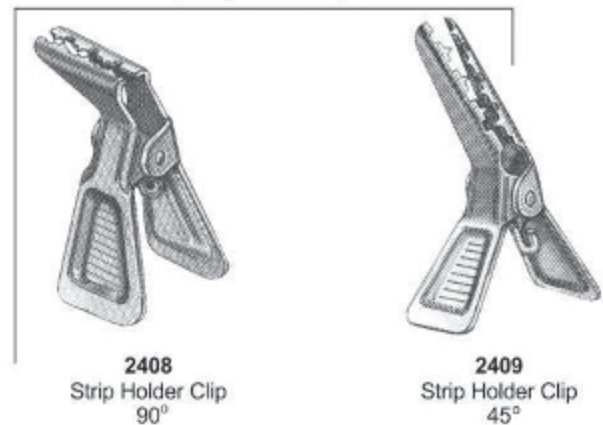

2405  
Finger Protector  
Small

2406  
Medium

2407  
Large

## Rubber Dam Instruments



**2410**  
IVORY  
Light weight, 170 mm



**2411**  
BREWER  
175 mm



**2412**  
BREWER  
175 mm



**2413**  
WHITE  
175 mm



**2414**  
IVORY  
170 mm



**2415**  
AINSWORTH  
Rubber Dam Punch  
170 mm



**2416**  
AINSWORTH  
Ainsworth  
Rubber Dam Punch  
170 mm



**2417**  
AINSWORTH  
Rubber Dam Punch  
170 mm

### Articulating Paper Forceps



**2421**  
MILLER  
Articulating  
Forceps  
15 cm



**2422**  
MILLER  
Articulating  
Forceps  
15 cm



**2418**  
"IV" Type  
Rubber Dam Punch  
160 mm



**2419**  
Plastic Rubber Dam  
Frame 242



**2420**  
Rubber Dam Holder  
Stainless Steel Pins

## Rubber Dam Clamps

### LOWER MOLARS



2423  
76D-W3

2424  
76D-3



2429  
76D-7A

2430  
76D-7



2435  
76D-12A

2436  
76D-13A



2441  
76D-26

2442  
76D-28



2445  
76D-W8A

2446  
76D-8A



2447  
76D-10

2448  
76D-11



2451  
76D-24

2452  
76D-25

### UPPER MOLARS



2425  
76D-4

2426  
76D-5



2431  
76D-8

2432  
76D-26N



2437  
76D-30

2438  
76D-31



2443  
76D-201

2444  
205

### MOLARS



2449  
76D-14

2450  
76D-118



2453  
76D-27

2454  
76D-56



2455  
76D-14A

### PREMOLARS



2427  
76D-0

2428  
76D-1



2433  
76D-2A

2434  
76D-2



2439  
76D-27N

2440  
76D-29

### ANTERIOR



2456  
76D-00

2457  
76D-1A



2458  
76D-9

2459  
76D-212

## Aspirating Syringes

4969/CO



4969/F



4969/CV



**2460**  
ml 1,8  
EU



**2461**  
ml 1,8  
EU/AM



**2462**  
ml 1,8  
EU/AM



**2463**  
Fig. 1  
ml 1,8  
EU



**2464**  
Fig. 1  
ml 1,8  
EU



**2465**  
Autoclavable  
black plastic handle  
passive automatic  
aspiration.



**2466**  
Fig. 1  
ml 1,8  
EU/Am



**2467**  
Fig. 1  
ml 1,8  
EU/Am



**2468**  
Fig. 1  
ml 1,8  
EU/Am



**2469**  
ml 1,2  
EU/Am

## Syringes

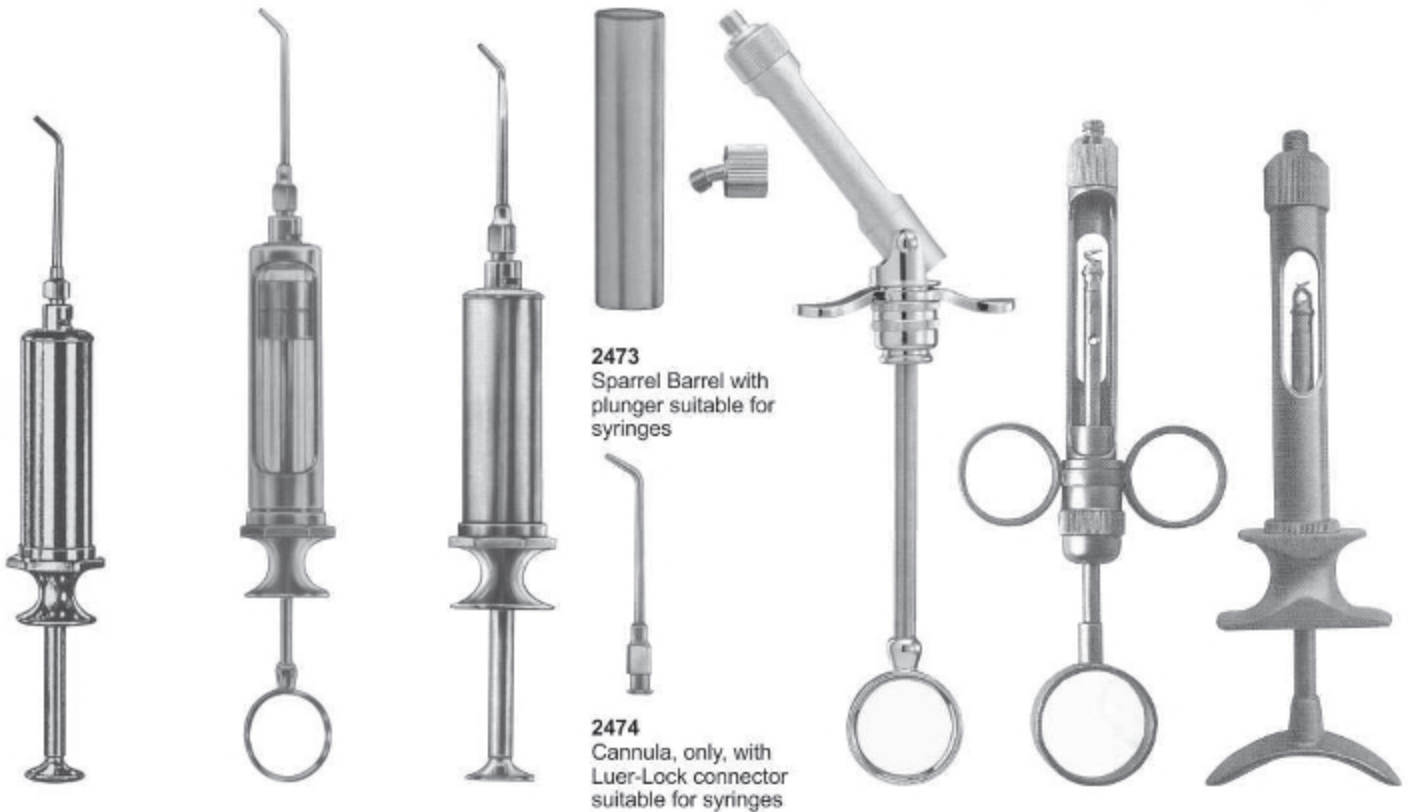

**2470**  
Water Syringe  
complete with  
1 cannula (Lure-Lock)

**2471**  
Water Syringe  
complete with  
1 cannula (Lure-Lock)

**2472**  
Metal Water Syringe  
self-filling, with 1  
cannula (Lure-Lock)

**2473**  
Sparrel Barrel with  
plunger suitable for  
syringes

**2474**  
Cannula, only, with  
Luer-Lock connector  
suitable for syringes

**2475**  
Articulating  
Barrel Syringe

**2476**  
ml 1,8

**2477**  
ml 1,8

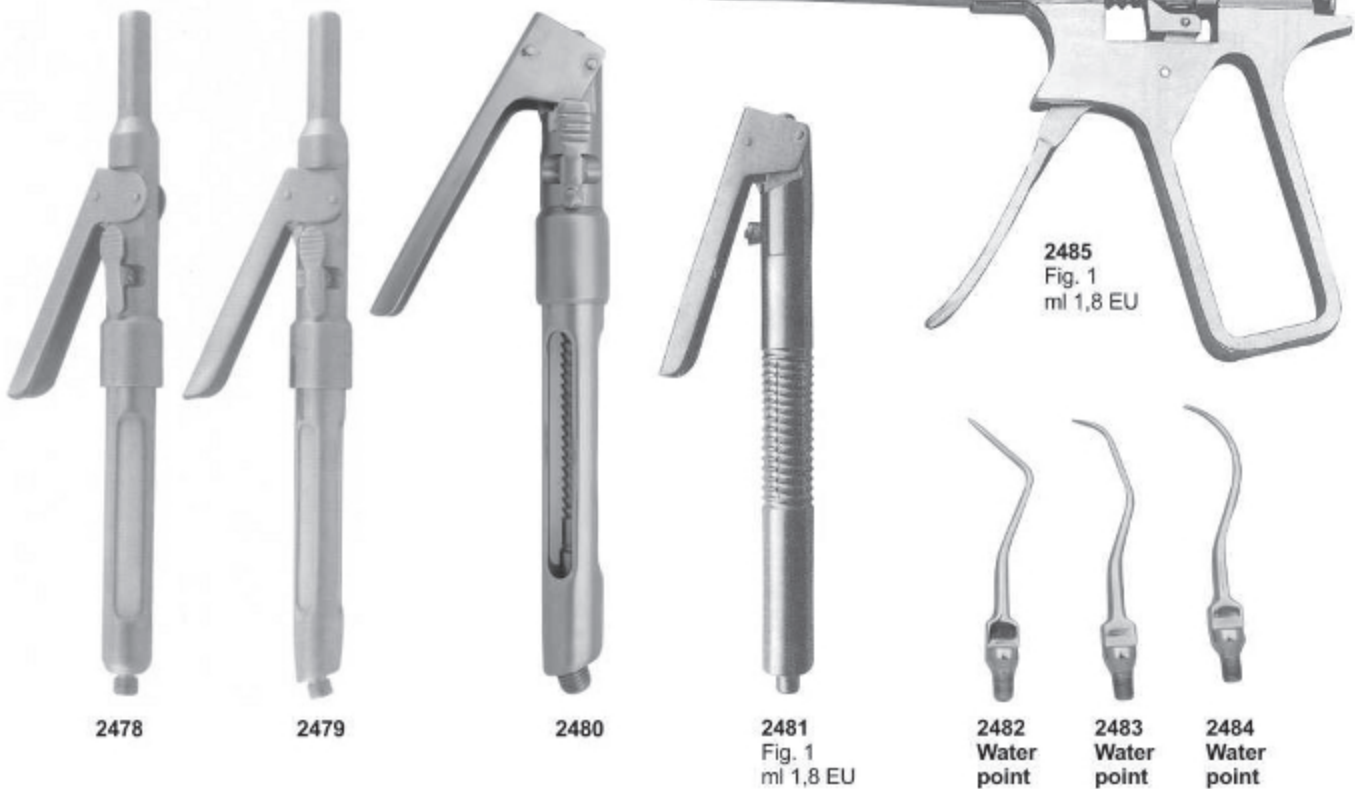

**2478**

**2479**

**2480**

**2481**  
Fig. 1  
ml 1,8 EU

**2485**  
Fig. 1  
ml 1,8 EU

**2482**  
Water  
point

**2483**  
Water  
point

**2484**  
Water  
point

## Dental Tweezers



**2486**  
ADSON  
Curved 14 cm



**2487**  
ADSON  
1X2 / 12 cm



**2488**  
ADSON  
12 cm



**2489**  
MICRO ADSON  
15 cm



**2490**  
STANDARD  
14, 18, 25 cm



**2491**  
CUSHING  
18 cm



**2492**  
Curved



**2493**  
SELECT  
15, 18, 20 cm



**2494**



**2495**  
MCINDOE  
15 cm



**2496**  
GILLIES  
15 cm



**2497**  
WAUGH  
15, 20 cm



**2498**  
PERRY  
13 cm



**2499**  
KOPP  
15.5 cm



## Dental Tweezers



**2500**  
COLLEGE  
15 cm



smooth



**2501**  
COLLEGE  
15 cm



serrated



**2502**  
COLLEGE  
15 cm



smooth



**2503**  
COLLEGE  
15 cm



smooth



**2504**  
COLLEGE  
15 cm



serrated



**2505**  
COLLEGE  
15 cm



smooth



**2506**  
COLLEGE  
15 cm



serrated



**2507**  
COLLEGE  
15 cm

# SECTION 06



- ▶ Endodontic Forceps
- ▶ Tissue Forceps
- ▶ Retractors
- ▶ Mouth Gags



## Dental Tweezers



**2508**  
MERIAM  
16 cm



smooth



**2509**  
MERIAM  
16 cm



serrated



**2510**  
MERIAM  
16 cm



smooth



**2511**  
MERIAM  
16 cm 1



serrated



**2512**  
MERIAM  
16 cm



smooth



**2513**  
MERIAM  
16 cm



serrated



**2514**  
MERIAM  
16 cm



smooth



**2515**  
MERIAM  
16 cm



serrated

## Dental Tweezers

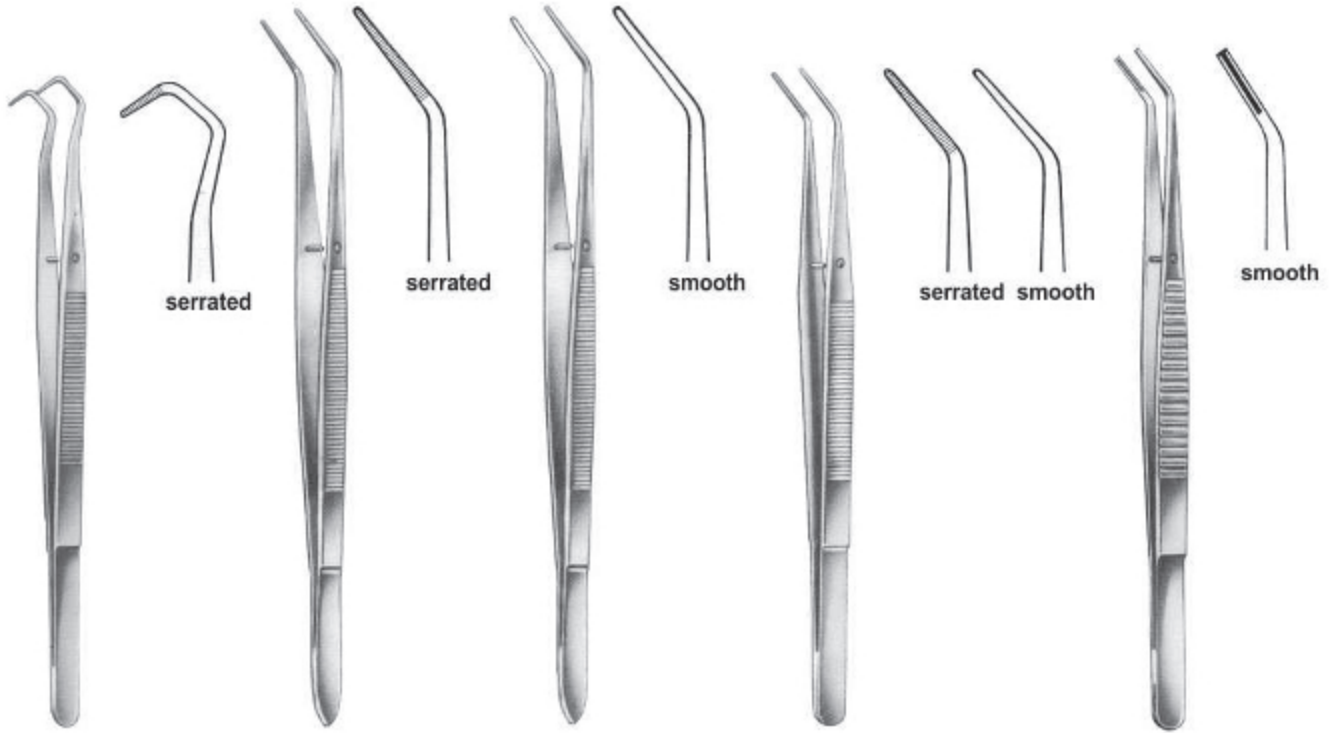

**2516**  
COLLEGE  
14.5 cm, 5<sup>3</sup>/<sub>4</sub>"

**2517**  
FLAGG  
16 cm, 6<sup>1</sup>/<sub>4</sub>"

**2518**  
FLAGG  
16 cm, 6<sup>1</sup>/<sub>4</sub>"

**2519**  
LANDGRAF  
15 cm, 6"

**2520**  
15.5 cm, 6<sup>1</sup>/<sub>8</sub>"

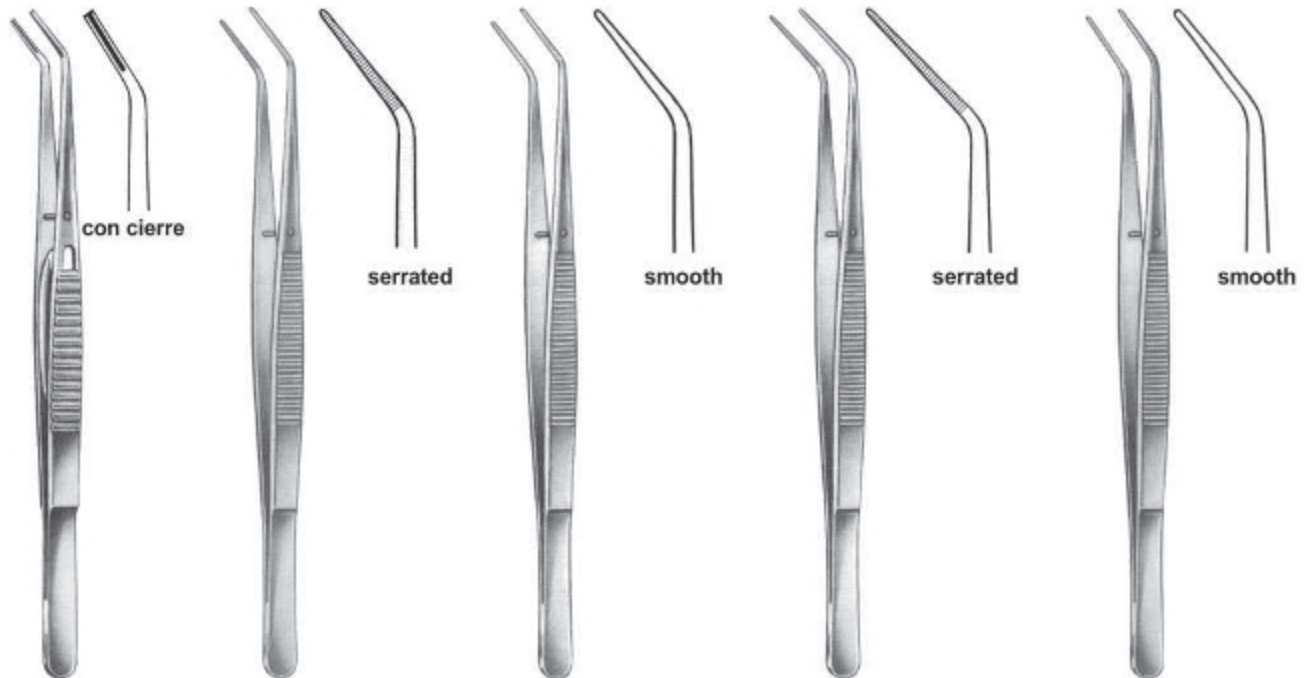

**2521**  
15.5 cm, 6<sup>1</sup>/<sub>8</sub>"

**2522**  
LONDON-COLLEGE  
15 cm, 6"

**2523**  
LONDON-COLLEGE  
15 cm, 6"

**2524**  
LONDON-COLLEGE  
15 cm, 6"

**2525**  
LONDON-COLLEGE  
15 cm, 6"

## Dental Tweezers



**2526**  
LONDON-COLLEGE  
15 cm, 6"



**2527**  
LONDON-COLLEGE  
15 cm, 6"



**2528**  
MERIAM  
16 cm, 6 1/4"



**2529**  
ALLEN  
18 cm, 7 1/8"



**2530**  
ALBRECHT  
16 cm, 6 1/4"



**2531**  
ALBRECHT  
16 cm, 6 1/4"



**2532**  
16 cm, 6 1/4"



**2533**  
16 cm, 6 1/4"



**2534**  
16 cm, 6 1/4"

## Sterilizing & Lab Instruments



**2535**  
DAVIS  
6"



**2536**  
Grasping Forceps  
6 1/4"



**2537**  
Mesh Bur & Diamond Holder  
Large, 2 1/8" Diameter



**2538**  
Soldering Tweezers  
6 1/4"



**2539**  
Narrow Fine  
4 3/4"



**2540**  
Super Fine  
4 3/8"



**2541**  
Fine Curved  
4 1/2"



**2542**  
Bonding Bracket  
Holder  
136 mm



**2543**  
Bonding Bracket  
Holder  
135 mm



**2544**  
Bonding Bracket  
Holder  
135 mm



**2545**  
Bonding Bracket  
Holder  
140 mm

## Endodontic Forceps



**2546**  
Endo Forceps  
4 3/4"



**2547**  
PEETS Forceps  
4 3/4", Useful For  
Removing Broken  
Instruments

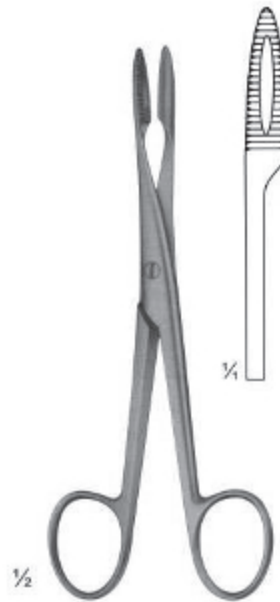

**2548**  
Without Ratchet  
145 mm

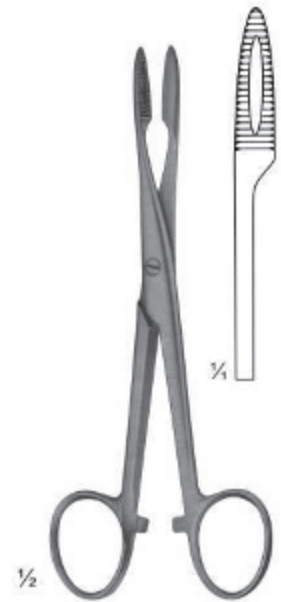

**2549**  
With Ratchet  
145 mm



**2550**  
CRILE  
140 mm

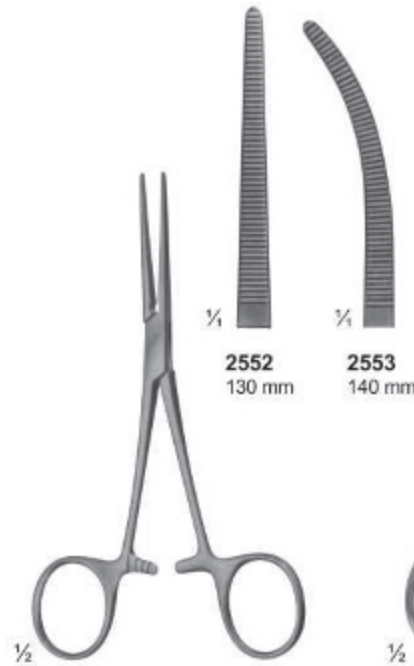

**2551**  
PEAN  
Slender type

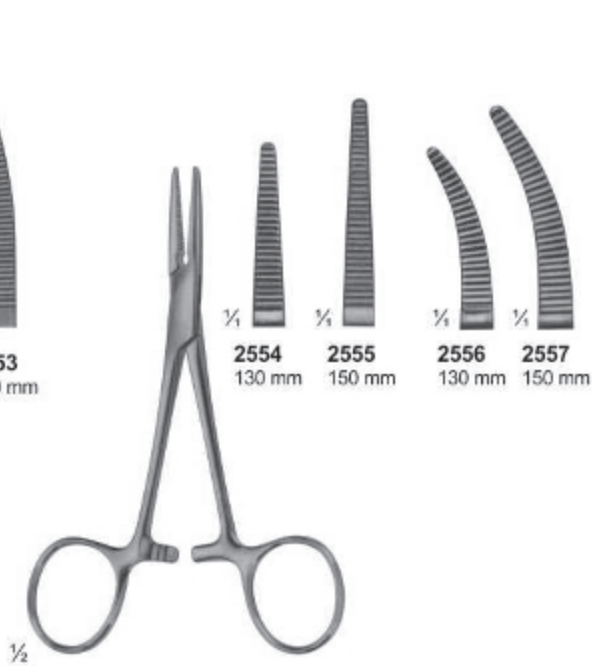

**2554**  
SPENCER-WELLS

## Tissue Forceps

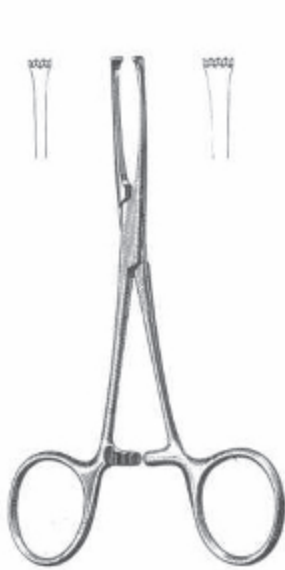

**2558**  
BABY-ALLIS  
5", Straight  
4x5 teeth extra delicate



**2559**  
ALLIS  
6", Straight  
4x5 teeth extra delicate



**2560**  
ALLIS  
6", Straight  
4x5 teeth extra delicate



**2561**  
1x2 teeth  
6"



**2562**  
SEMKIN  
6", Straight,  
1x2 teeth



**2563**  
ADSON  
4 3/4"  
1x2 teeth



**2564**  
BROWN-ADSON  
4 3/4"  
7x7 teeth



**2565**  
BROWN  
6"  
8x8 teeth



**2566**  
RUSSIAN  
6"  
8x8 teeth



**2567**  
Extra-Delicate,  
Straight, 4"  
1x2 teeth



## Hemostatic Forceps, Towel Clamps, Napkin Holders



**2568**  
HALSTED-MOSQUITO  
Straight, Curved, 5"



**2569**  
HALSTED-MOSQUITO  
Straight, Curved, 5"  
1x2 teeth



**2570**  
HALSTED-MOSQUITO  
Jaws 45 Angled on Flat, 5"  
Extra Delicate



**2571**  
KELLY  
5 1/2", Straight



**2572**  
JONES  
3 1/2"



**2573**  
BACKHAUS  
3 1/2"



**2574**  
BACKHAUS  
5 1/4"



**2575**  
LORNA  
Non Perforated  
3 1/2"

## Retractors, Depressors, Mouth Gags

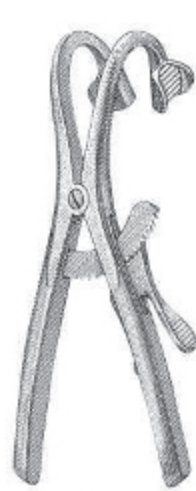

**2576**  
DENHART



**2577**  
DENHARDT  
Mouth Gag With  
Silicon Inserts,  
Interchangeable  
Size: 125 mm

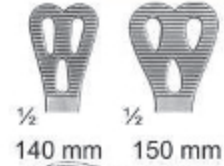

**2578**  
WIEDER  
Tongue depressor  
**2579** 140mm  
**2580** 150mm

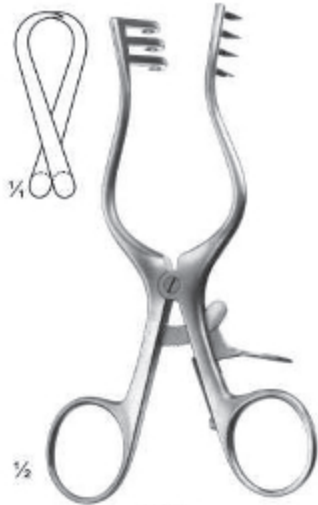

**2583**  
WEITLANER  
Sharp  
130 mm



**2584**  
WEITLANER  
Sharp  
110 mm



**2585**  
WEITLANER  
Semi-Sharp  
110 mm



**2581**  
TOBOLD  
Tongue depressor  
Size: 145 mm



**2582**  
ANDREW  
Tongue depressor  
Size: 110 mm



**2586**  
MOLT  
Pediatric



**2587**  
MOLT  
Child



**2588**  
MOLT  
Adult



**2589**  
FERGUSSON-ACKLAND  
Mouth Gag  
Size: 145 mm



**2590**  
ROSER KOENIG  
Mouth Gag  
Size: 160mm / 185mm

# SECTION 07



- ▶ Orthodontic Pliers
- ▶ Orthodontic Cutters
- ▶ Rongeurs
- ▶ Needle Holders

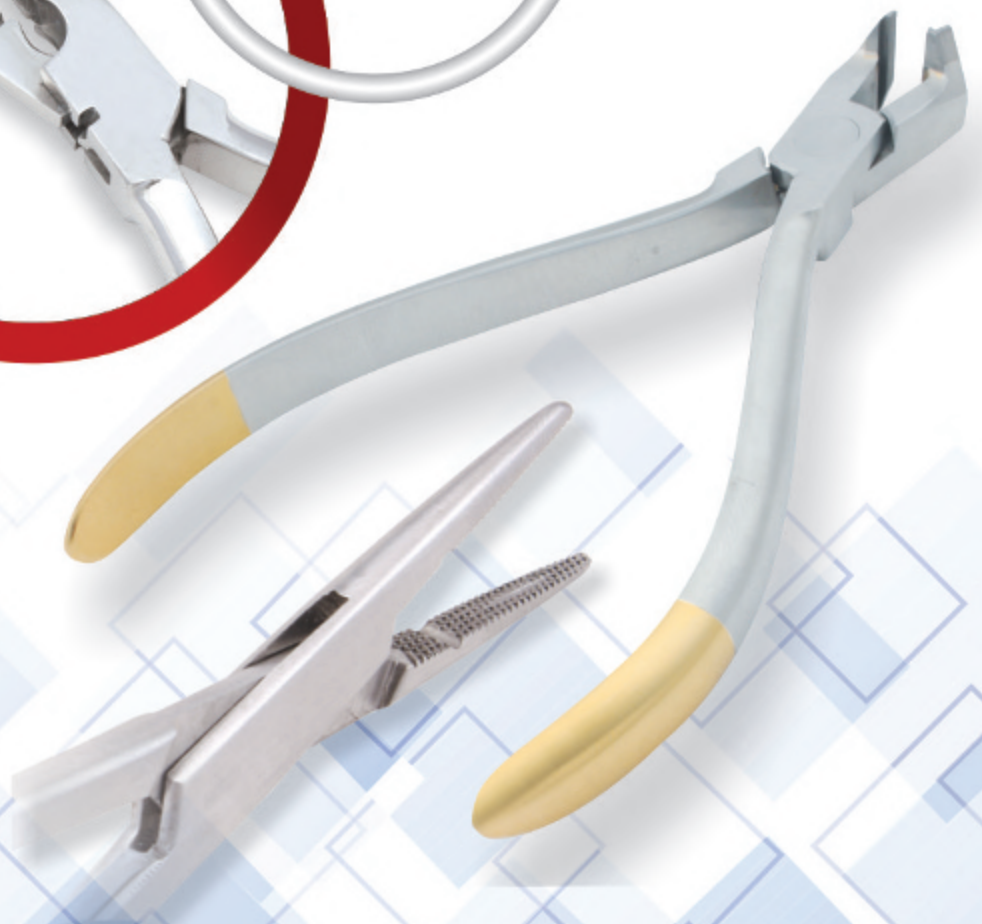

## Lip & Cheek Retractors

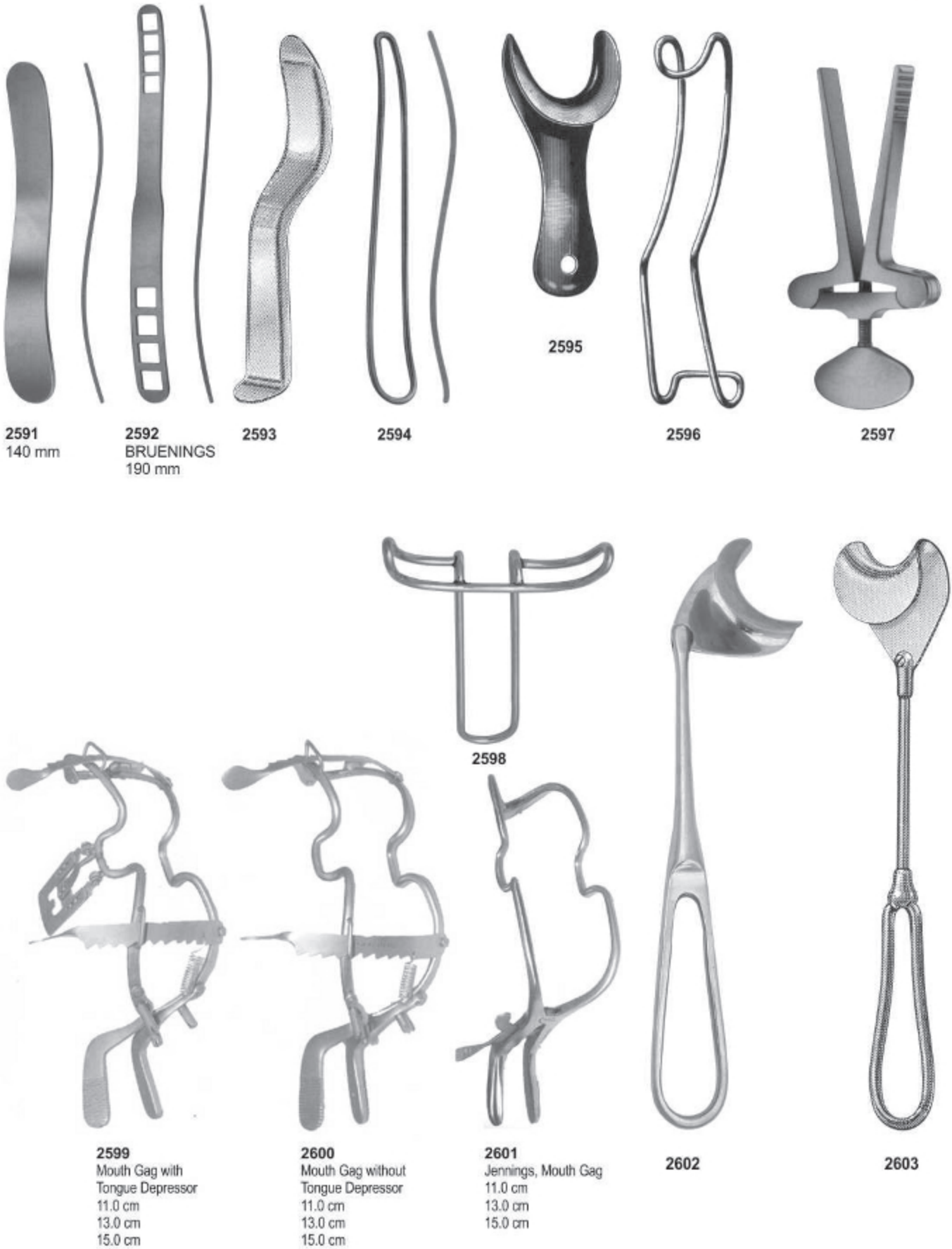

## Lip & Cheek Retractors

30 x 4 mm A  
23 x 7 mm B  
24 x 11 mm C  
29 x 10 mm D  
30 x 11 mm E  
32 x 14 mm F  
40 x 11 mm G  
42 x 10 mm H  
50 x 11 mm I  
55 x 11 mm J  
60 x 11 mm K  
70 x 11 mm L  
70 x 14 mm M



**2604**  
LANGENBECK  
210 mm



**2605**  
KOCHER-LANGENBECK  
215 mm



**2606**  
BUCHS  
205 mm



38 x 18 mm



**2607**  
KOCHER  
230 mm



**2608**  
MIDDELDORPF



**2609**  
15 x 15 mm  
220 mm



**2610**  
20 x 22 mm  
215 mm



**2611**  
28 x 28 mm  
235 mm



**2612**  
KOCHER  
230 mm



**2613**  
COLLIN  
150 mm



**2614**  
ROUX  
Set  
165 mm

## Sterilizing Forceps



**2615**  
Sterilizing Forcep Curved  
20 cm A  
25 cm B  
30 cm C



**2616**  
Sterilizing Forcep Straight  
20 cm A  
25 cm B  
30 cm C



**2617**  
Sterilizing Forcep  
30 cm



**2618**  
Becht Tweezer



**2619**  
Sterilizing Forcep  
23 cm A  
30 cm B



**2620**  
Sterilizing Forcep  
20 cm



## Tissue Retractors & Hooks



**2621**  
3 sharp prongs



**2622**  
2 sharp prongs  
6"



**2623**  
2 sharp prongs  
6"



**2624**  
FOMON  
145 mm



**2625**  
ALM  
70 mm



**2626**  
SENN  
3 sharp prongs  
6 3/8"



**2627**  
TOENNIS  
Dura Retractor  
150mm



**2628**  
JOSEPH  
165 mm



**2629**  
GILLIES  
180 mm

## Orthodontic Pliers



**2630**  
Light Wire Cutter



**2631**  
Wire Cutter



**2632**  
Posterior Band Remover  
Long



**2633**  
Posterior Band Remover  
Short



**2634**  
Jarabak Plier



**2635**  
Distal End Cutter  
Safety End Cutter



**2636**  
Distal End Cutter



**2637**  
Kim's Plier



**2638**  
Loop Forming Plier



**2639**  
Tweed Arch Bending Plier



**2640**  
Utility Plier



**2641**  
Bonding Bracket Remover



**2642**  
Lingual Arch Plier



**2643**  
Light Wire Plier



**2644**  
Wire Cutter  
12.5 cm



## Orthodontic Pliers

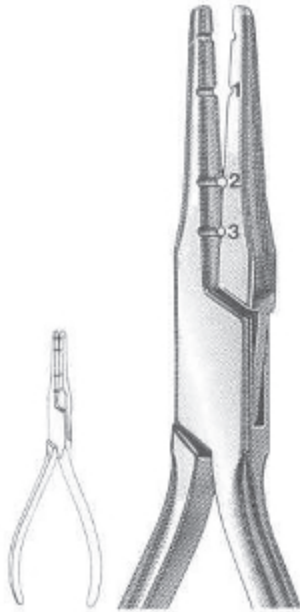

**2645**  
Fig. 101  
Wire Bending

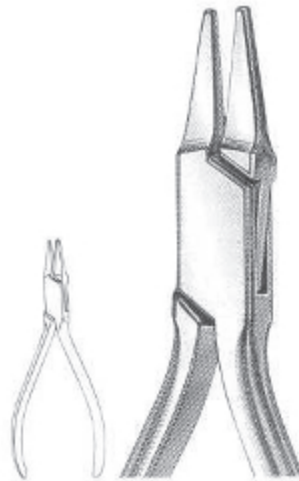

**2646**  
Fig. 118  
PEESO  
Collar

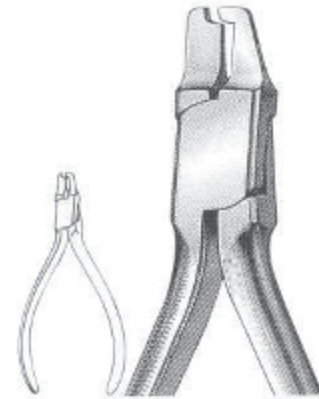

**2647**  
Fig. 417  
Crown Shell

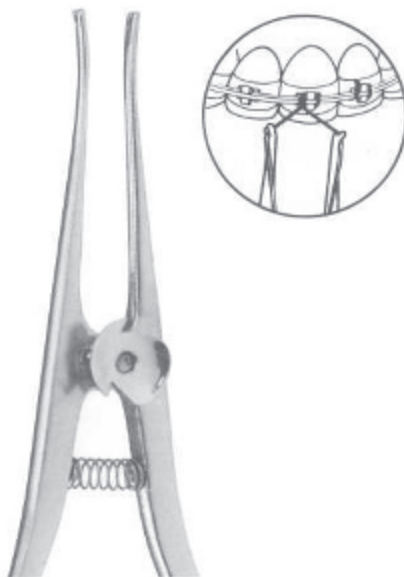

**2648**  
STEINER  
150 mm  
Ligature Pliers

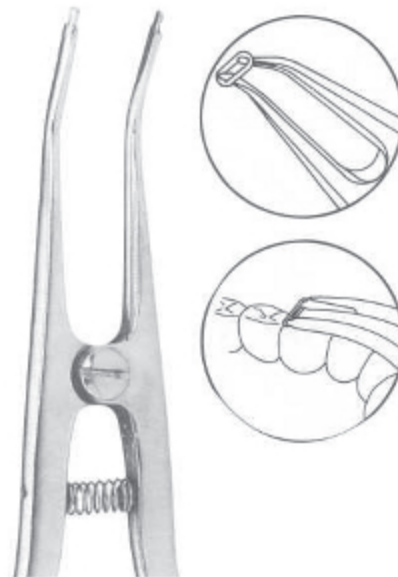

**2649**  
Separating Pliers Elastics  
150 mm



**2650**  
121-Lab & Office

## Orthodontic Pliers



**2651**  
How Plier-Titanium Alloy  
With special coated beaks



**2652**  
How Plier  
Tips are 1/8"(3.2mm)  
diameter



**2653**  
How Plier  
Tips are 1/8"(3.2mm)  
diameter



**2654**  
How Plier-Small  
Tips are 3/32"(2.4mm)  
diameter



**2655**  
How Plier-Offset  
Tips are 1/8"(3.2mm)  
diameter



**2656**  
Weingart Utility Plier  
-Titanium Alloy  
with special coated beaks

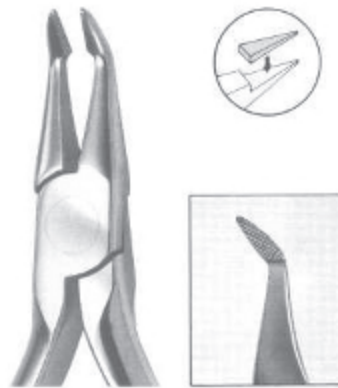

**2657**  
Weingart Utility Plier  
New type of the Weingart Utility Plier  
designed for a more precise operation.



**2658**  
Weingart Utility Plier

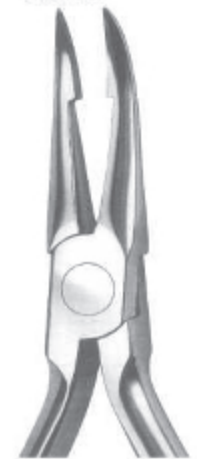

**2659**  
Weingart Utility Plier

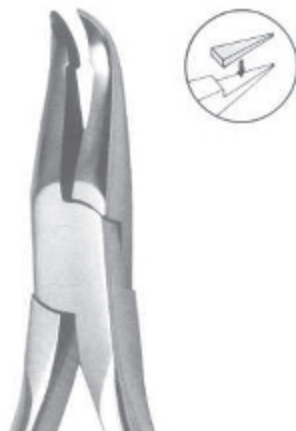

**2660**  
Weingart Utility Plier

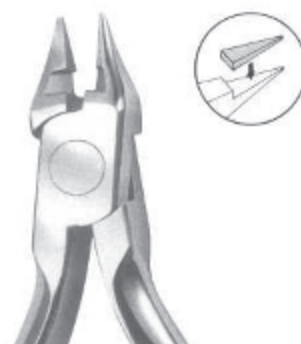

**2661**  
Bird Beak Plier With Cutter  
Maximum Bending &  
Cutting Capacity:  
Wires up to .032"

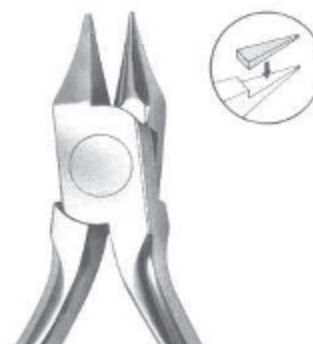

**2662**  
Bird Beak Plier  
Maximum Bending Capacity:  
Wires up to .032"



**2663**  
Bird Beak Plier  
Maximum Bending  
Capacity:  
Wires up to .030"

## Orthodontic Pliers



**2664**  
TWEED (Fig. 98)  
13 cm, 5 1/8"  
Tweed Loop Omega Pliers.



**2665**  
TWEED - (Fig. 90)  
14 cm, 5 1/2"



**2666**  
O'BRIEN - (Fig. 97)  
14 cm, 5 1/2"



**2667**  
TWEED (Fig. 96)  
14 cm, 5 1/2"



**2668**  
TWEED (Fig. 95)  
13.5 cm, 5 1/4"

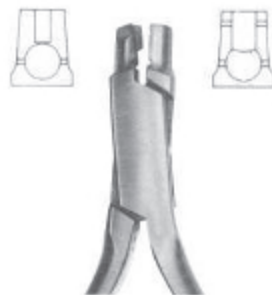

**2669**  
SCHWARZ (Fig. 29)  
12.5 cm, 5"



**2670**  
NANCE (Fig. 80)  
13 cm, 5 1/8"

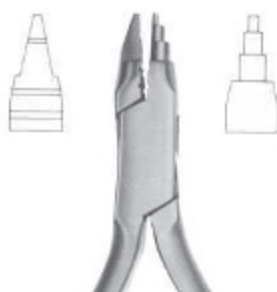

**2671**  
YOUNG (Fig. 55)  
13 cm, 5 1/8"



**2672**  
SCHWARZ (Fig. 30)  
13 cm, 5 1/8"



**2673**  
Optical Plier (Fig. 53)  
14 cm, 5 1/2"

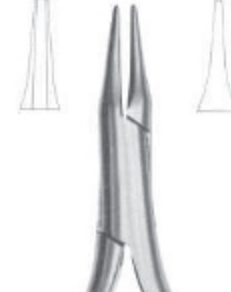

**2674**  
Schwarz (Fig. 79)  
13.5 cm, 5 1/4"

## Orthodontic Pliers



**2675**  
NANCE (Fig. 56)  
12.5 cm, 5"  
Wire bending Pliers



**2680**  
14.0 cm  
Goslee Contouring Plier



**2676**  
JOHNSON (Fig. 59)  
13.5 cm, 5 1/4"  
Contouring Plier.



**2678**  
De La Rosa (Fig. 34)  
12.5 cm, 5"  
Contouring Plier, Non-Grooved



**2677**  
REYNOLDS (Fig. 61)  
13 cm, 5 1/8"  
Contouring Plier.



**2679**  
De La Rosa (Fig. 35)  
12.5 cm, 5"  
Contouring Plier, Grooved



**2681**  
14.0 cm  
Goslee Contouring Plier

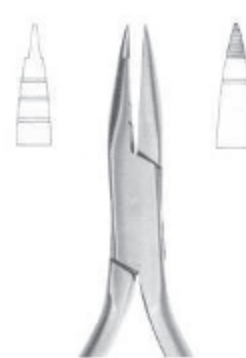

**2682**



**2683**  
Fig. 58  
12.5 cm, 5"  
Lingual Arch Bending Plier



**2684**  
Frevort/Tweed (Fig. 51)  
12.5 cm, 5"  
Tweed Arch Plier/Standard Jaw



**2685**



**2686**  
ANGLE (Fig. 52)  
13 cm, 5 1/8"  
Arch Forming Plier

## Orthodontic Pliers



**2687**  
Fig. 60  
13 cm, 5 1/8"  
Wire & Clasp Bending Pliers



**2688**  
Fig. 60  
13 cm, 5 1/8"  
Wire & Clasp Bending Pliers

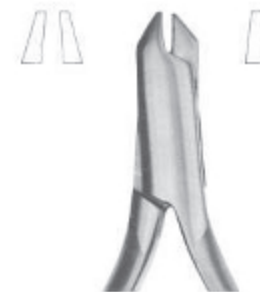

**2689**  
Aderer (Fig. 57)  
12 cm, 4 3/4"  
Wire & Clasp Bending Pliers



**2690**  
49 e 49 TC  
14 cm, 5 1/2"  
Band Removing Plier, short pad



**2691**  
50 e 50 TC  
14 cm, 5 1/2"  
Band Removing Plier, long pad



**2692**  
Fig. 84  
14.5 cm, 5 3/4"  
Band pinshing & ligature locking plier, serrated



**2693**  
Fig. 72  
14 cm, 5 1/2"  
Band pinshing & ligature locking plier, serrated



**2694**  
BRACKET (Fig. 82)  
13.5 cm, 5 1/4"  
Direct Bonding Bracket Remover



**2695**  
BRACKET (Fig. 83)  
13.5 cm, 5 1/4"  
Direct Bonding Bracket Remover

## Orthodontic Pliers



**2696**  
38c, 38TC  
13.5 cm, 5 1/4"  
Contouring closing loop pliers,  
wire bending, cutter.

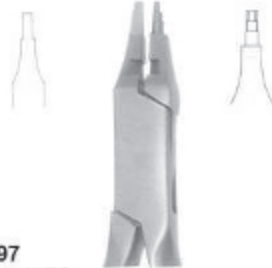

**2697**  
40c, 40TC  
13.5 cm, 5 1/4"  
Contouring pliers light wire pliers  
grooved with cutter.



**2698**  
Fig. 81  
12.5 cm, 5"  
Sling clasp & wire bending plier



**2699**  
Fig. 28  
14 cm, 5 1/2"  
Sling clasp & wire bending plier.



**2700**  
Fig. 21  
13 cm, 5 1/8"  
Light wires pliers, grooved



**2704**  
46c - 46 TC  
ADAMS - N. 139c  
12.5 cm, 5"  
Bird beak with cutter.



**2701**  
ADAMS, 23, 23TC  
12.5 cm, 5"  
Sling clasp & wire bending plier.



**2702**  
ADAMS (Fig. 33)  
12.5 cm, 5"  
For retaining elements.



**2703**  
ADAMS (Fig. 44)  
12.5 cm, 5"  
Sling clasp & wire bending plier.



**2705**  
Universal Wire Bending  
Pliers (ADAMS) 47 TC, N.64  
12.5 cm, 5"  
Sling clasp & wire bending plier.



**2706**  
86c, 86 TC  
Angle Bird Beak - N.138  
12.5 cm, 5"  
Sling clasp & wire bending plier.

## Orthodontic Distal End Cutters with T.C.



Ø 1.0 mm  
(0.40")

**2707**  
Fig. 18 TC  
15 cm, 6"



Ø 1.0 mm  
(0.40")

**2708**  
Fig. 92 TC  
14 cm, 5 1/8"



Ø 0.4 mm  
(0.16")

**2709**  
Fig. 91 TC  
13 cm, 5 1/8"



Ø 0.4 mm  
(0.16")

**2710**  
Fig. 99 TC  
13 cm, 5 1/8"



Ø 0.4 mm  
(0.16")

**2711**  
Fig. 94 TC  
13 cm, 5 1/8"  
Angled at 15° with or  
without spring on \  
the handles.



**2712**  
Fig. 85 TC  
13 cm, 5 1/8"



**2713**  
Fig. 87 TC  
13 cm, 5 1/8"



**2714**  
Fig. 85 TC  
Angled at 15°  
13 cm, 5 1/8"



**2715**  
ADAMS 87 TC  
Angled at 15°  
13 cm, 5 1/8"

## Orthodontic Distal End Cutters





## Pliers for Orthodontics & Prosthetics



**2721**  
UNIVERSAL  
150 mm



**2722**  
WALDSACHS  
155 mm



**2723**  
ADERER  
125 mm



**2724**  
NANCE  
125 mm



**2725**  
REYNOLDS  
125 mm



**2726**  
HOW  
145 mm



**2727**  
HOW  
140 mm



**2731**  
FURRER  
150 mm



**2728**  
WALDRON  
125 mm



**2729**  
ADAMS  
125 mm



**2730**  
ANGLE  
125 mm

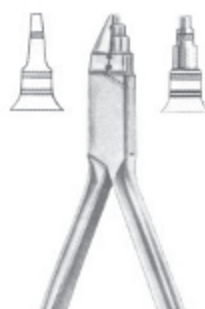

**2732**  
YOUNG  
130 mm



**2733**  
NANCE  
130 mm

## Pliers for Orthodontics & Prosthetics



**2734**  
LANGEBECK  
125 mm



**2735**  
LANGEBECK  
140 mm



**2736**  
LANGEBECK  
130 mm



**2737**  
PEESO  
125 mm



**2738**  
GOSLEE  
125 mm



**2739**  
FISCHER  
140 mm



**2740**  
FISCHER  
140 mm



**2741**  
JOHNSON  
130 mm



**2742**  
MSY  
130 mm



**2743**  
MC KELLOPS  
155 mm



**2744**  
ANDRESEN  
130 mm



**2745**  
SCHWARZ  
130 mm

# SECTION 08



- ▶ Scissors
- ▶ Impression Trays
- ▶ Articulators
- ▶ Hollow Ware
- ▶ T.C. Instruments



**Rongeurs**



**2746**  
BLUMENTHAL  
6", 30°, Standard

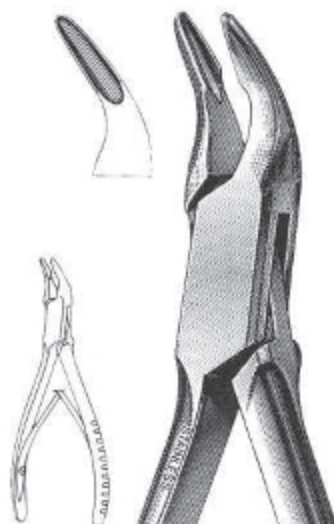

**2747**  
MINI-BLUMENTHAL  
6", 45°

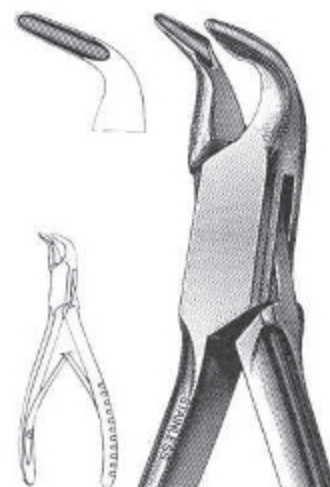

**2748**  
MINI-BLUMENTHAL  
6", 90°

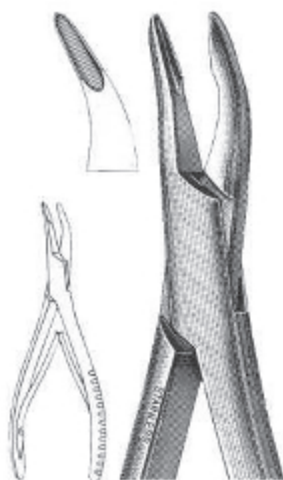

**2749**  
BLUMENTHAL  
7", 30°



**2750**  
MINI-BLUMENTHAL  
4 1/2", 30°

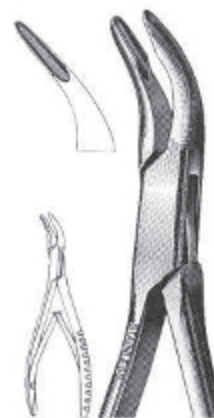

**2751**  
MINI-BLUMENTHAL  
4 1/2", 45°

**Rongeurs**



**2752**  
CLEVELAND  
No. 5-Side Cutting,  
6 3/4"

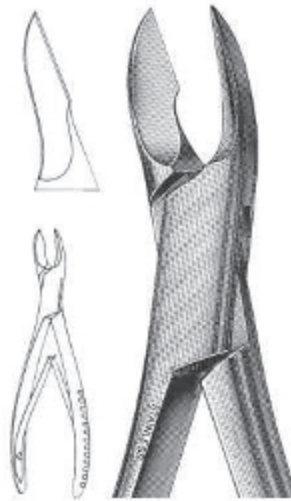

**2753**  
CLEVELAND  
No. 5A-Side Cutting,  
6 1/2"

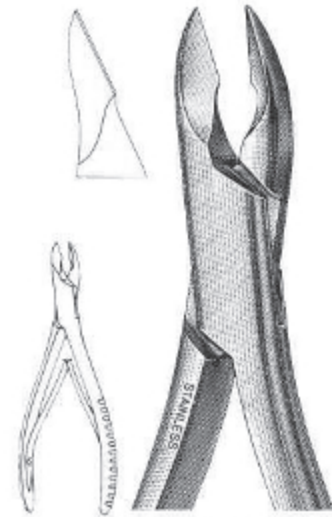

**2754**  
CLEVELAND  
No. 5S-Side Cutting,  
6"

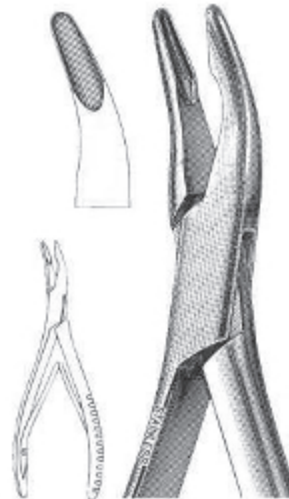

**2755**  
No. 1A-MEAD  
6 1/2"

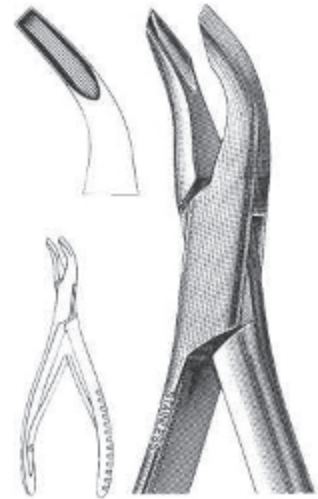

**2756**  
MEAD, Square  
No. 2A  
Tips, 6 1/2"

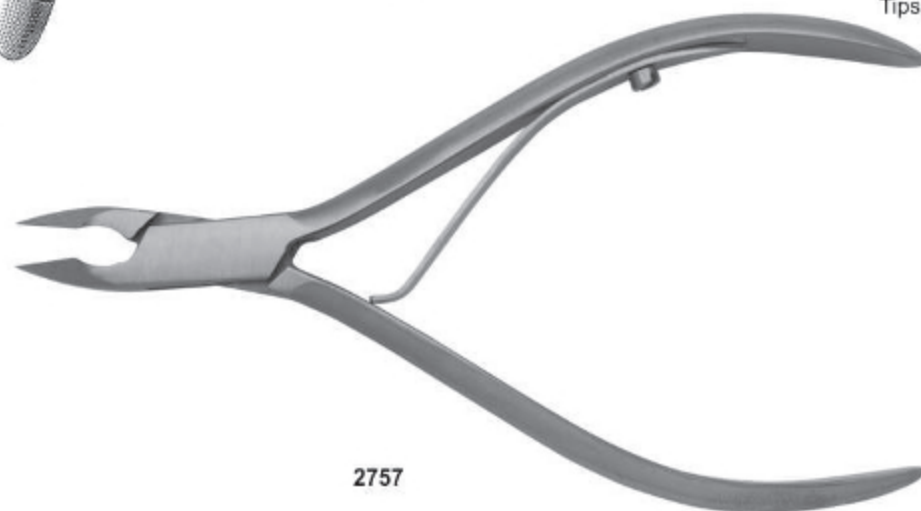

**2757**

**Rongeurs**



**2757**  
FRIEDMAN  
5 1/2"

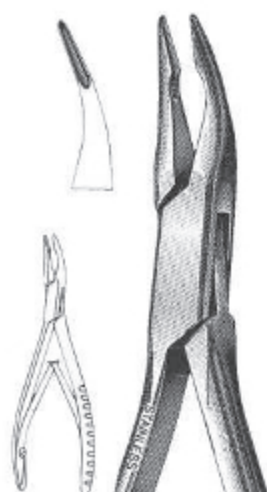

**2758**  
MICRO-FRIEDMAN  
5 1/2", 15° Curved Jaws

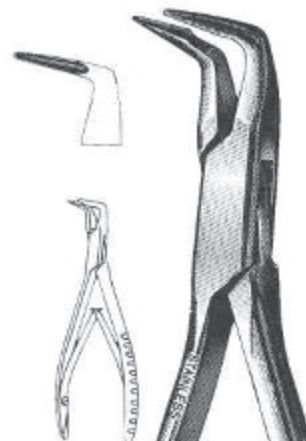

**2759**  
MICRO-FRIEDMAN  
Perio Rongeur, 5 1/2"

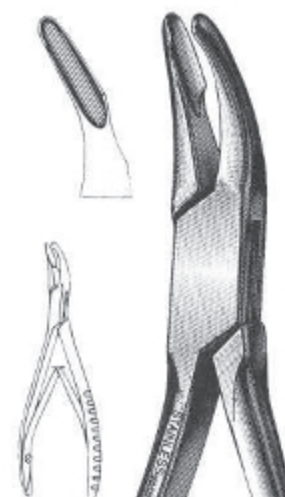

**2760**  
CLEVELAND  
No. 4 - 5 1/2"

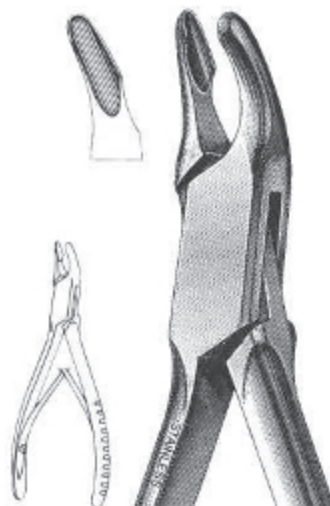

**2761**  
CLEVELAND  
No. 4A - 6 1/2"

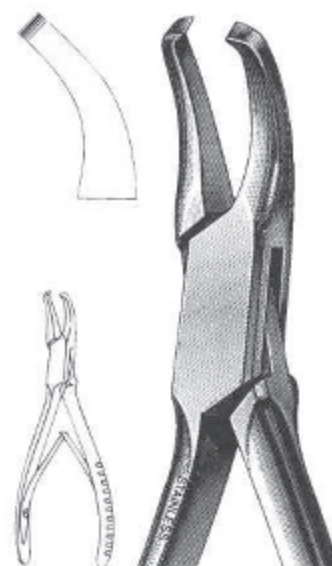

**2762**  
GARDNER  
No. 6A, End Cutting  
6 1/2"

## Rongeurs



2763  
BEYER  
Double Action,  
16,18 cm

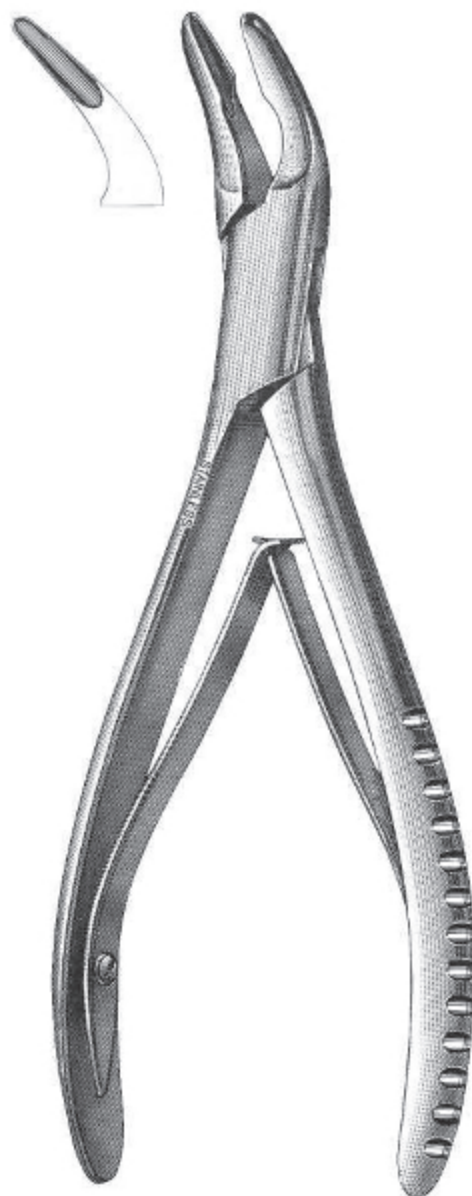

2764  
No. 1  
6 1/2"

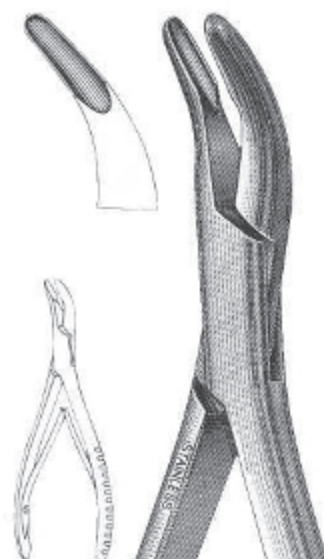

2765  
HARTMAN  
5 3/4"  
Strong Curve

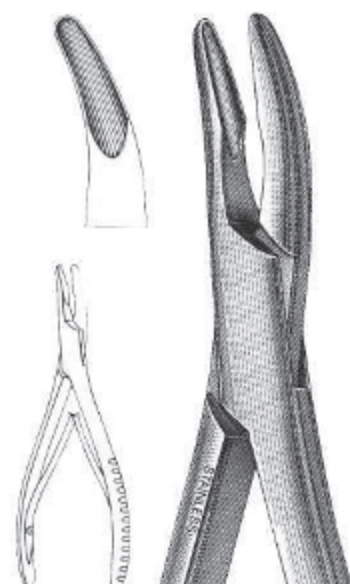

2766  
BANE  
Slight Curve  
7"

## Needle Holders



**2767**  
COLLIER  
5", Fenestrated Jaws



**2768**  
DERF  
4 3/4"



**2769**  
WEBSTER  
Delicate Smooth Jaws  
5"



**2770**  
NEIVERT  
One Offset Ring  
5"



**2771**  
OLSEN-HEGAR  
5 1/2"



**2772**  
BAUMGARTNER  
5 1/2"



**2773**  
CRILE-WOOD  
6"



**2774**  
GARDNER  
5"



## Needle Holders

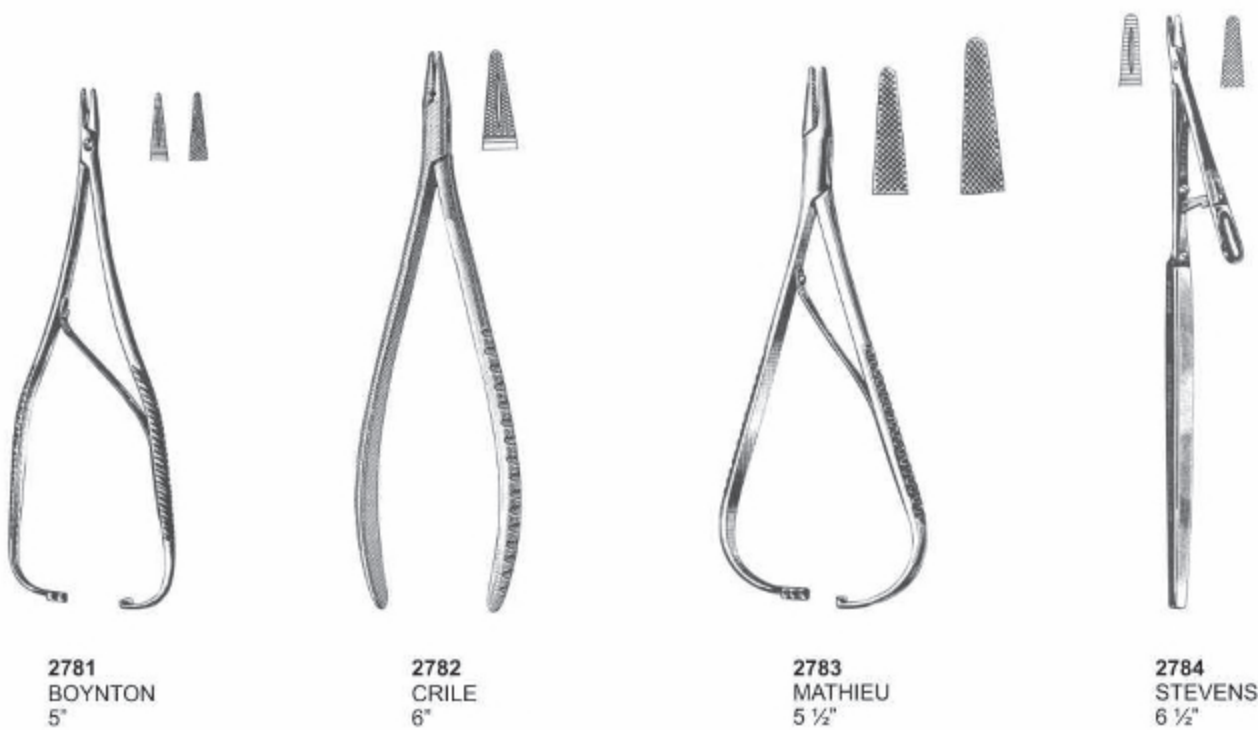
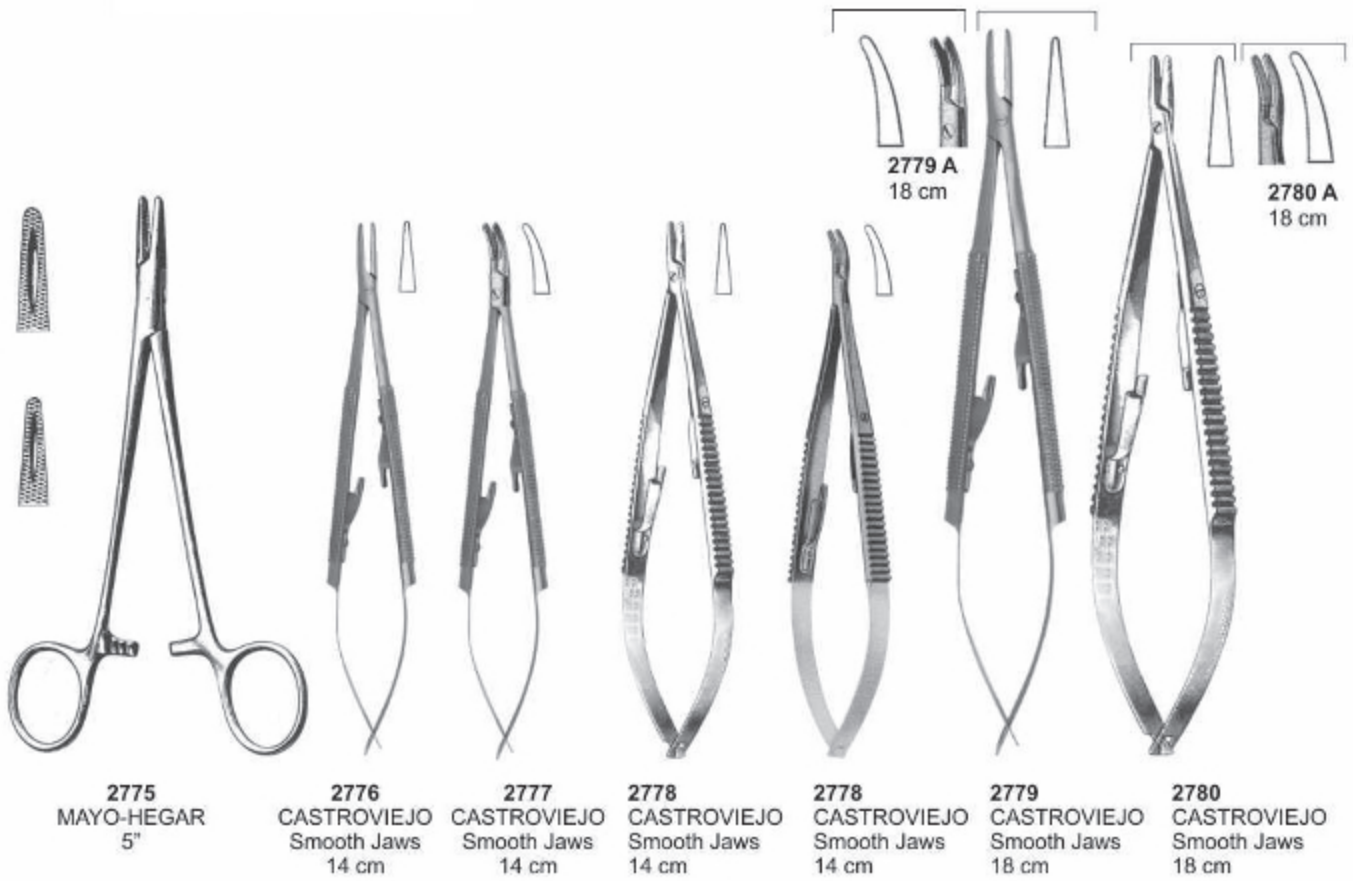

## Micro Surgery Set



**2785**  
Micro Scissor  
Straight, 155 mm



**2786**  
Micro Scissor  
Straight, 150 mm



**2787**  
Micro Scissor  
Curved, 150 mm



**2788**  
Micro Scissor  
Curved, 155 mm



**2789**  
CASTROVIEJO  
T.C.  
Straight, 180 mm



**2790**  
Retractor  
Fig.3  
165 mm



**2791**  
Micro Adson  
120 mm



**2792**  
GERALD  
Curved,  
180 mm



**2793**  
GERALD  
Straight,  
175 mm



**2794**  
Micro Adson  
160 mm

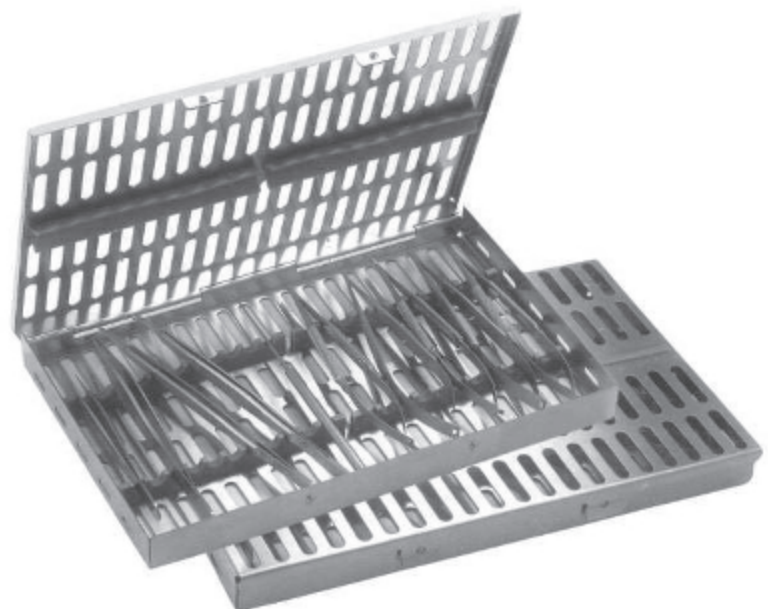

**2795**  
Micro Surgery Set 10 Pieces.

**Scissors**

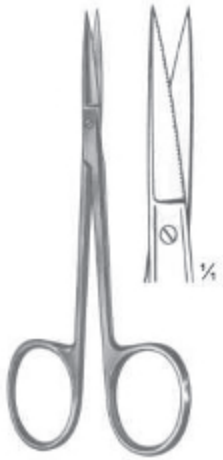

**2796**  
IRIS (Standard)  
Straight  
11.5 cm, 4 1/2"

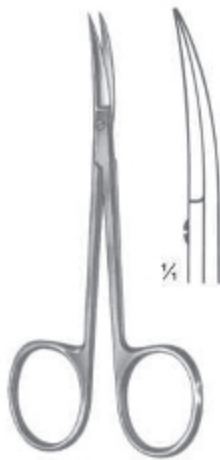

**2797**  
IRIS (Standard)  
Curved  
11.5 cm, 4 1/2"

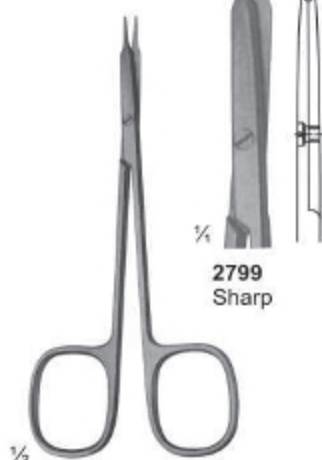

**2798**  
STEVENS  
Dissecting Scissors  
Size: 115 mm



**2799**  
Sharp



**2800**  
Sharp



**2801**  
Blunt



**2802**  
Blunt



**2803**



**2804**  
JOSEPH  
Size: 150 mm

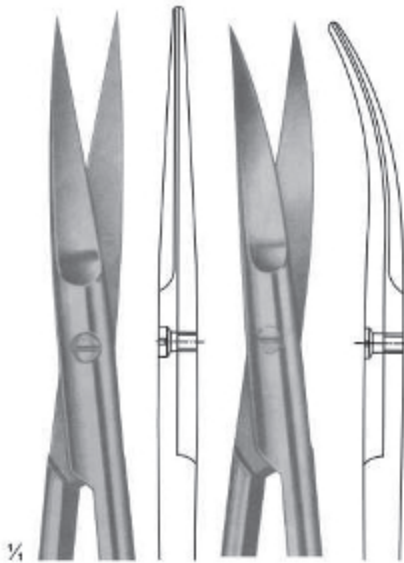

**2805**

**2806**

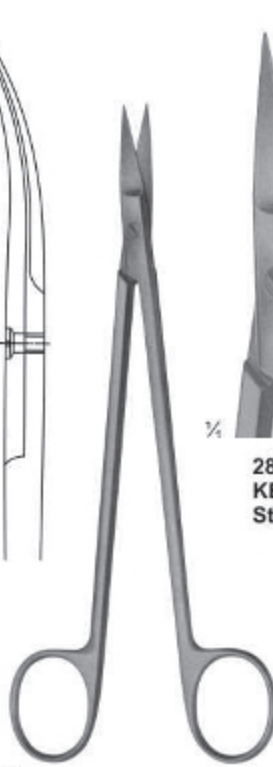

**2807**  
KELLY  
Size: 175 mm

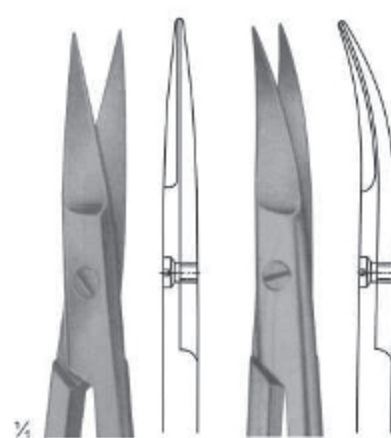

**2808**  
KELLY  
Straight

**2809**  
KELLY  
Curved

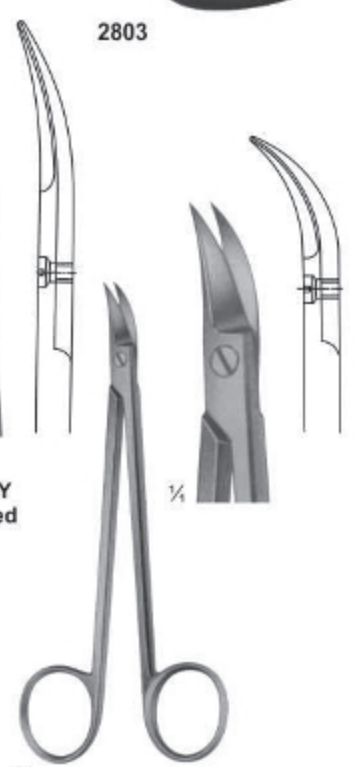

**2810**  
QUINBY  
Size: 130 mm

## Scissors

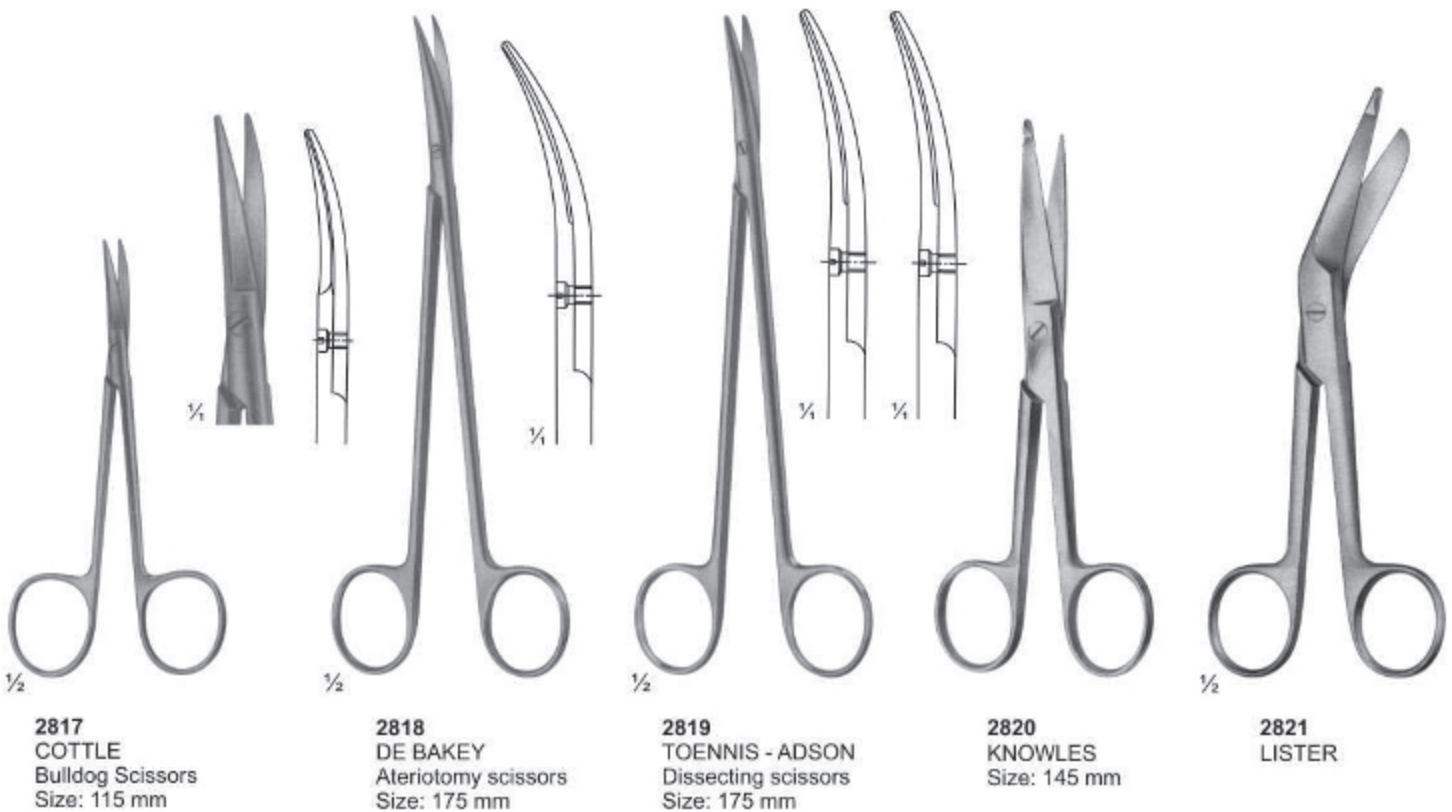
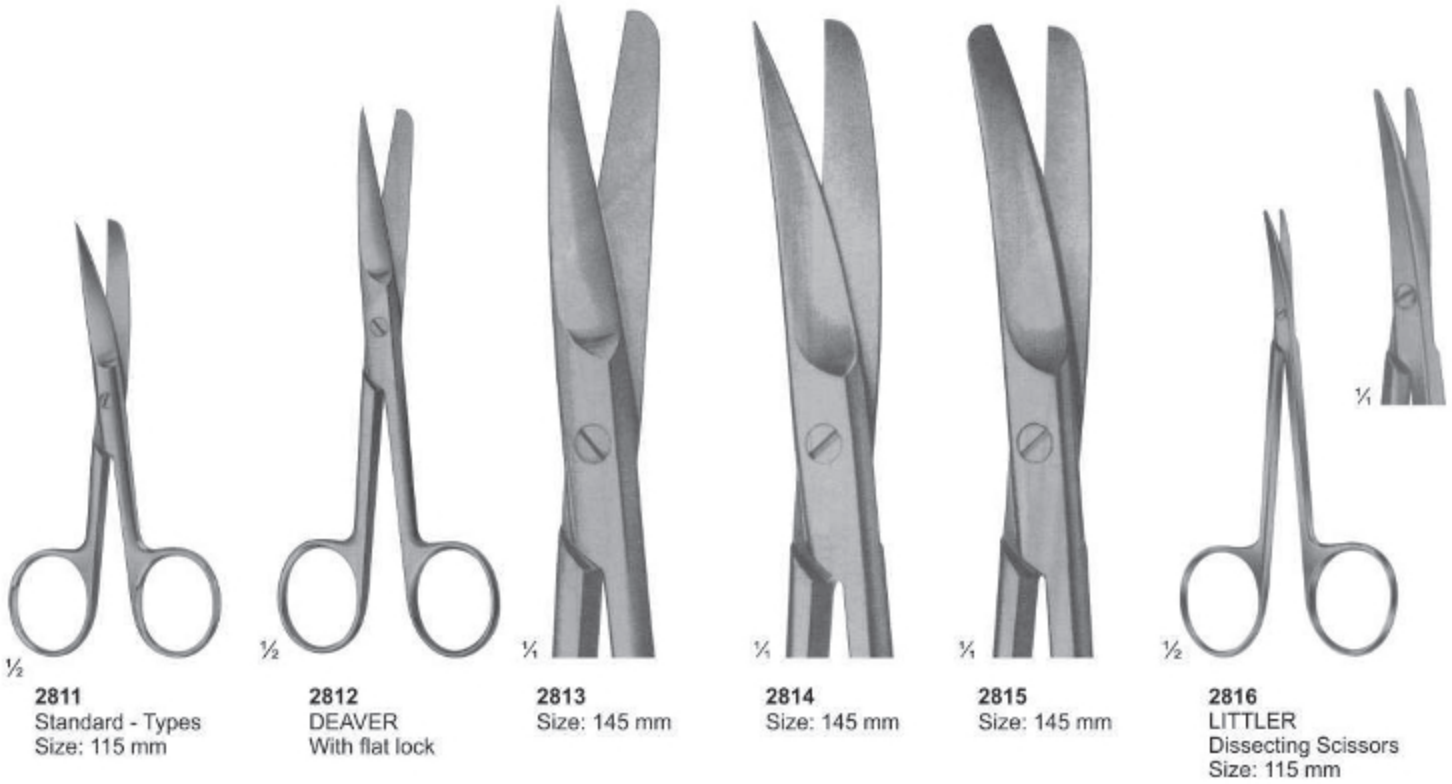

## Scissors

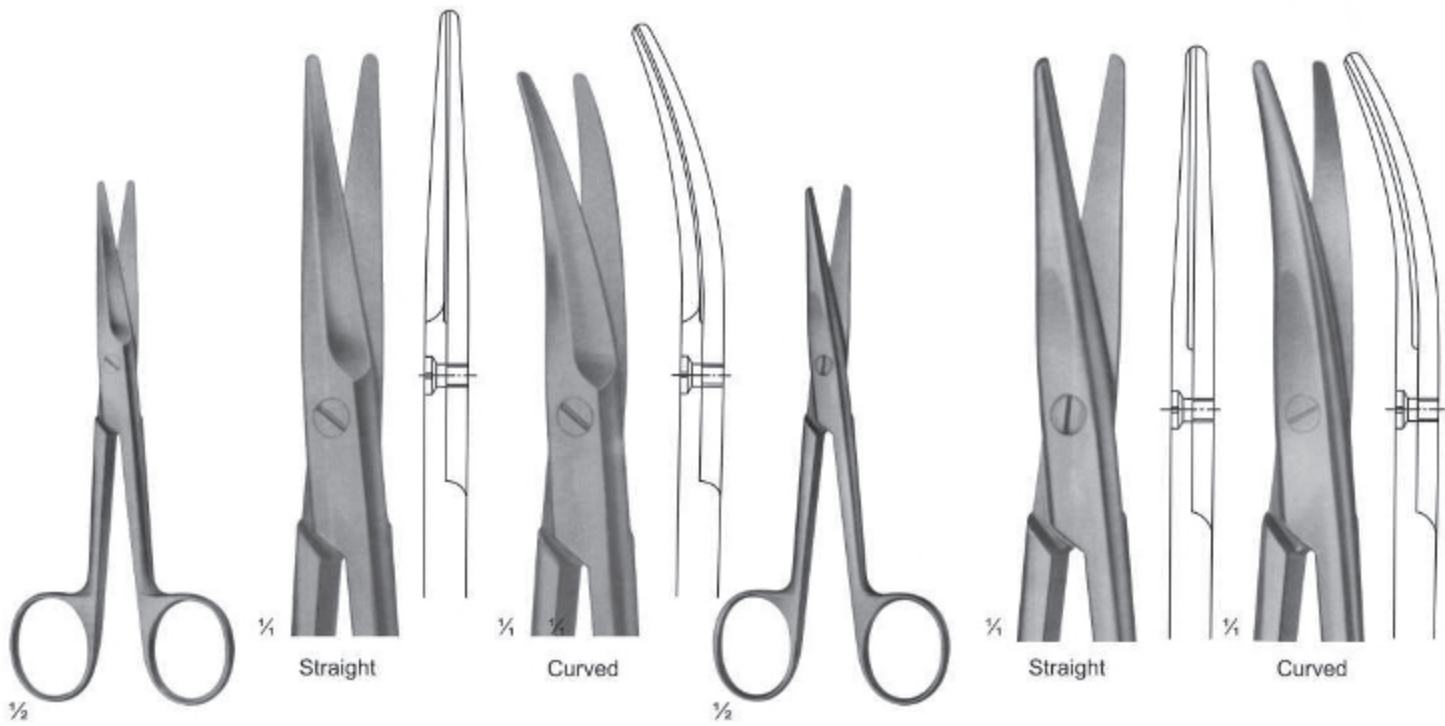

**2822**  
MAYO(straight)  
Size: 140 mm

**2823**  
MAYO-STILLE (straight)  
Size: 140 mm

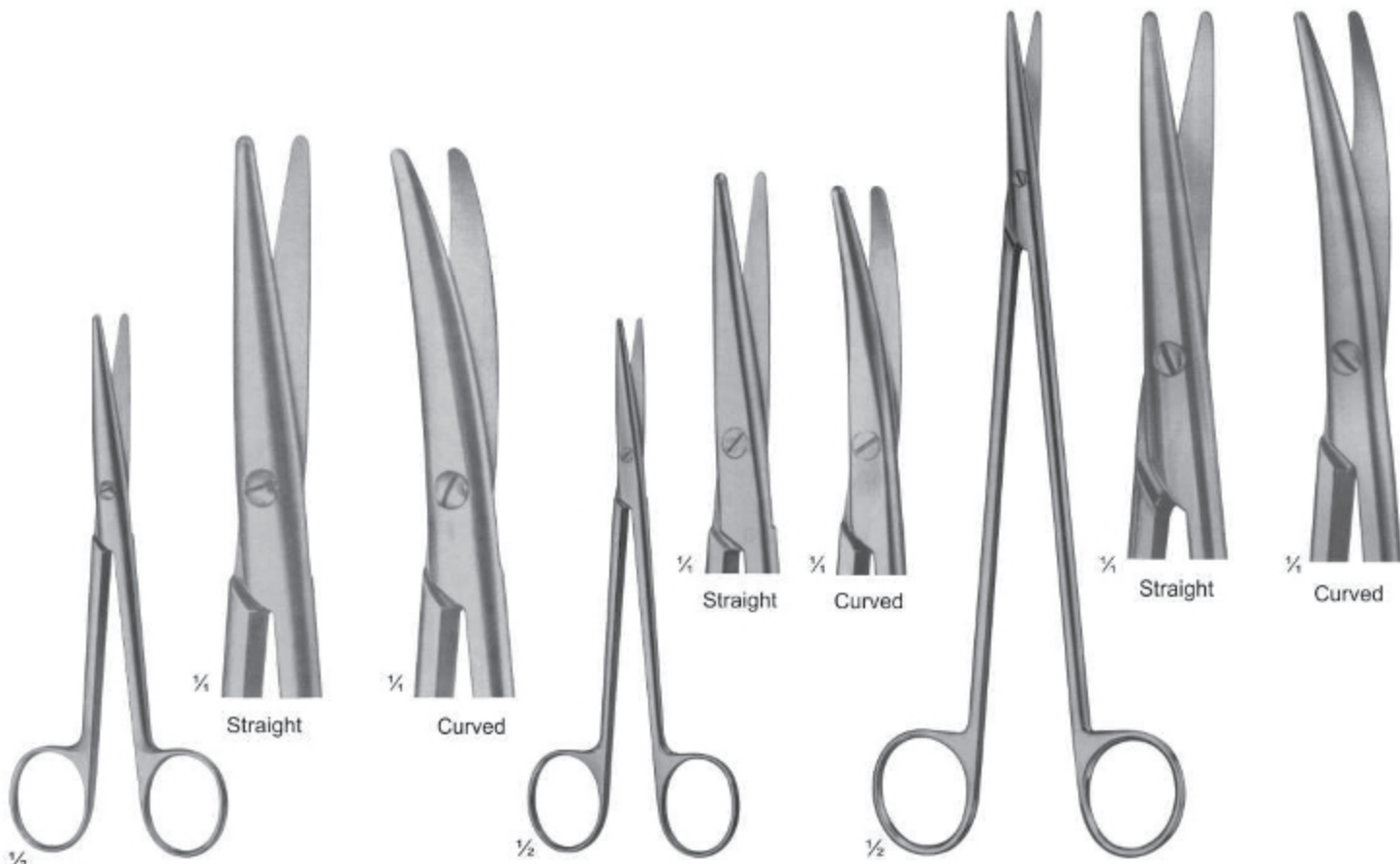

**2824**  
STILLE  
Size: 140 mm

**2825**  
METZENBAUM  
Size: 145 mm

**2826**  
NELSON-METZENBAUM  
Size: 230 mm

## Scissors

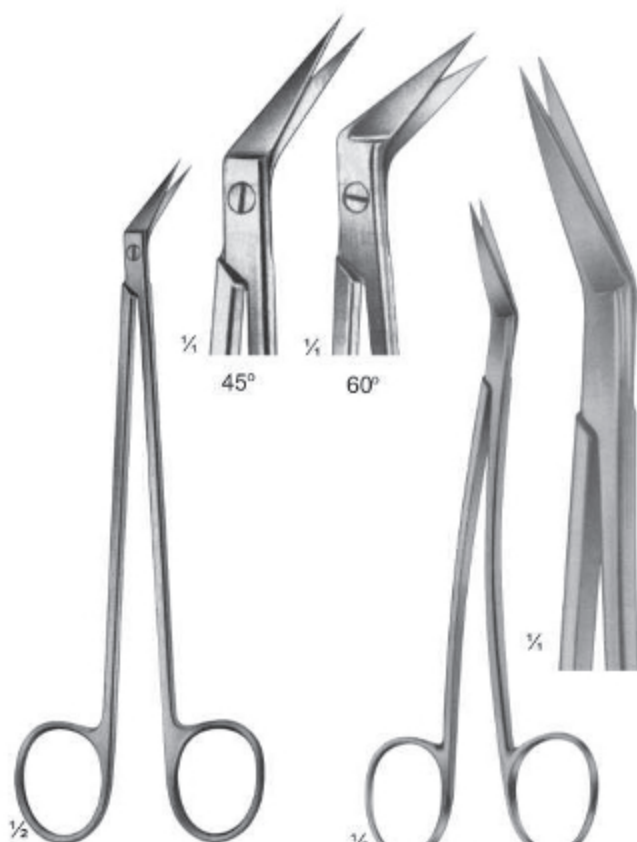

**2827**  
DE BAKEY  
Size: 155 mm

**2828**  
LOCKLIN  
Curved Sideways,  
1 Toothed Blade  
Size: 155 mm



**2829**  
LaGrange  
Double-Curved  
11.5 cm

**2830**  
Goldman-Fox  
Double-Curved  
13cm



**2831**  
SPENCER  
Size: 90 mm

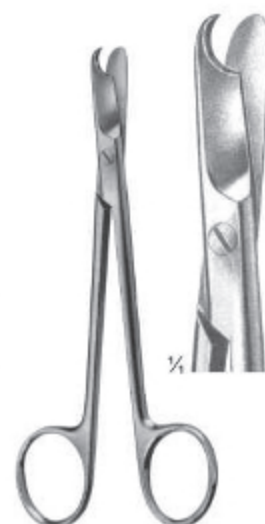

**2832**  
LITTAUER  
Size: 135 mm



**2833**  
BEEBE  
Size: 110 mm

**2834**

**2835**

**2836**

**2837**



**2838**  
Dean  
17cm

**2839**  
1 Blade Serrated  
Size: 120 mm



**2840**  
CASTROVIEJO  
Size: 90 mm

## Impression Trays

Made of 18/8 Stainless Steel, Solid, Set of 10

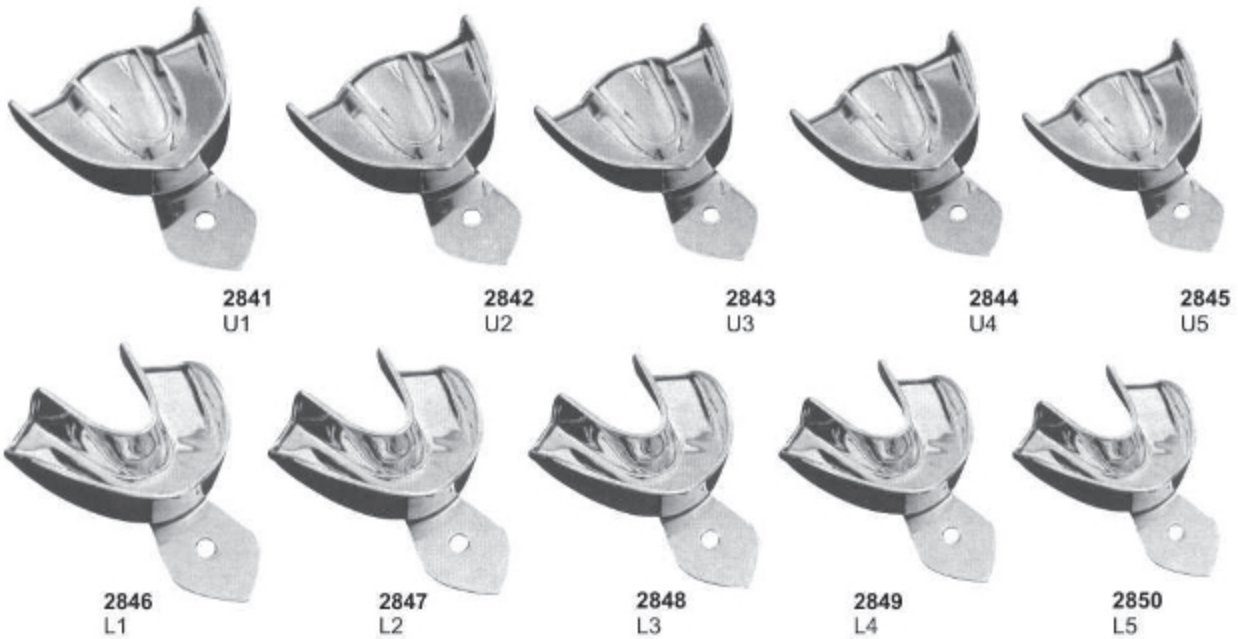

All The Above Impression Trays are Available in These 5 Sizes

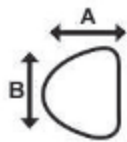

UPPER	U1	U2	U3	U4	U5
A	62	60	53	54	52
B	83	75	73	69	68

All Dimension are in mm

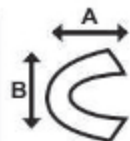

LOWER	L1	L2	L3	L4	L5
A	63	61	57	60	53
B	82	81	78	74	71

All Dimension are in mm

### Perforated, Set of 10

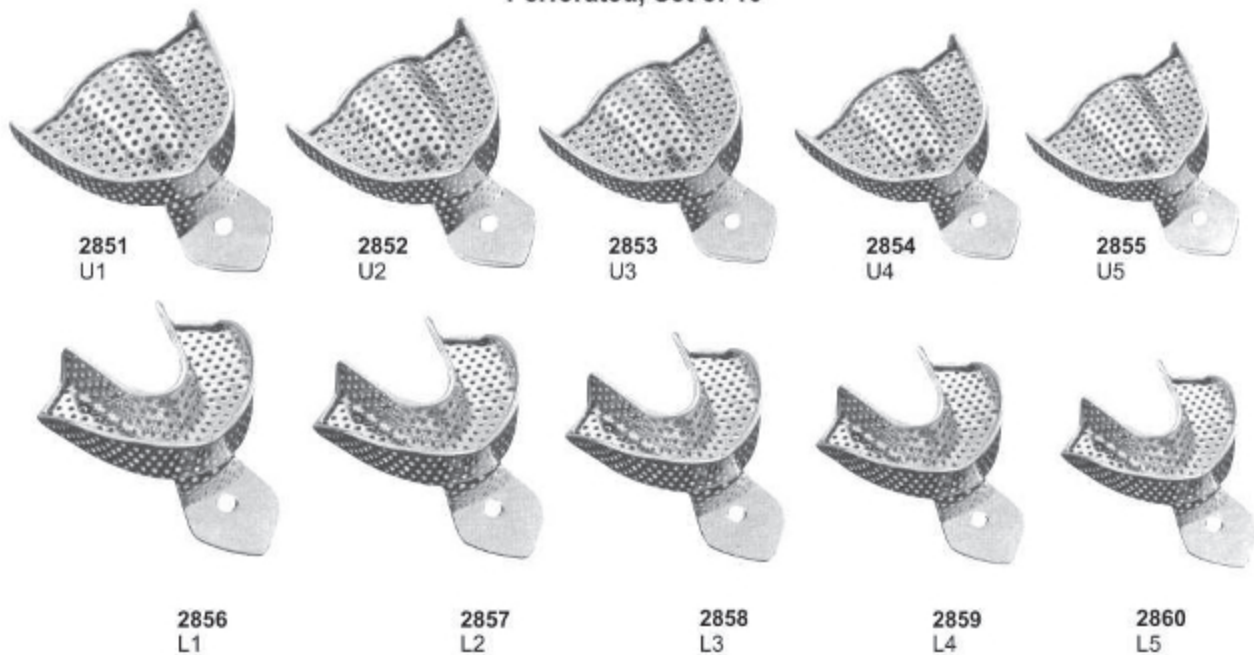

## Impression Trays

Made of 18/8 Stainless Steel, Solid Full Denture Set of 8

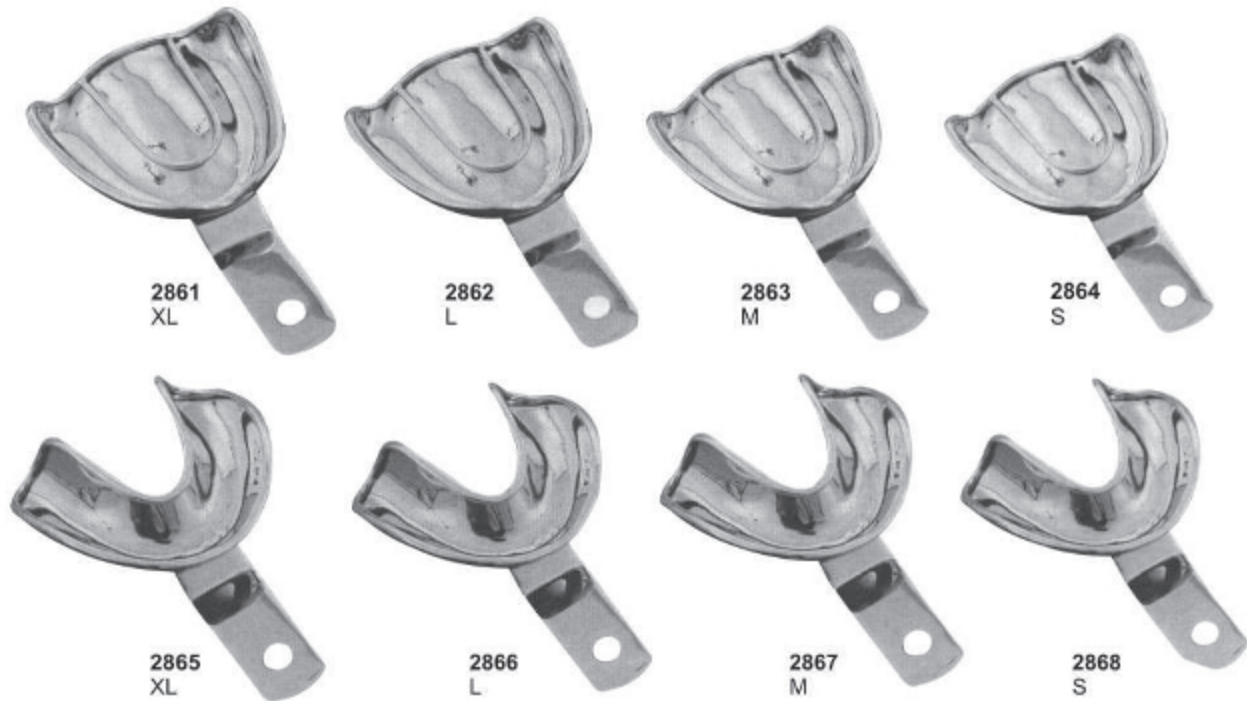

All The Above Impression Trays are Available in These 4 Sizes

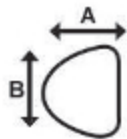

UPPER		XL	L	M	S
	A	70	67	64	60
B	79	76	70	73	

All Dimension are in mm

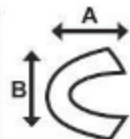

LOWER		XL	L	M	S
	A	64	64	60	57
B	86	70	73	70	

All Dimension are in mm

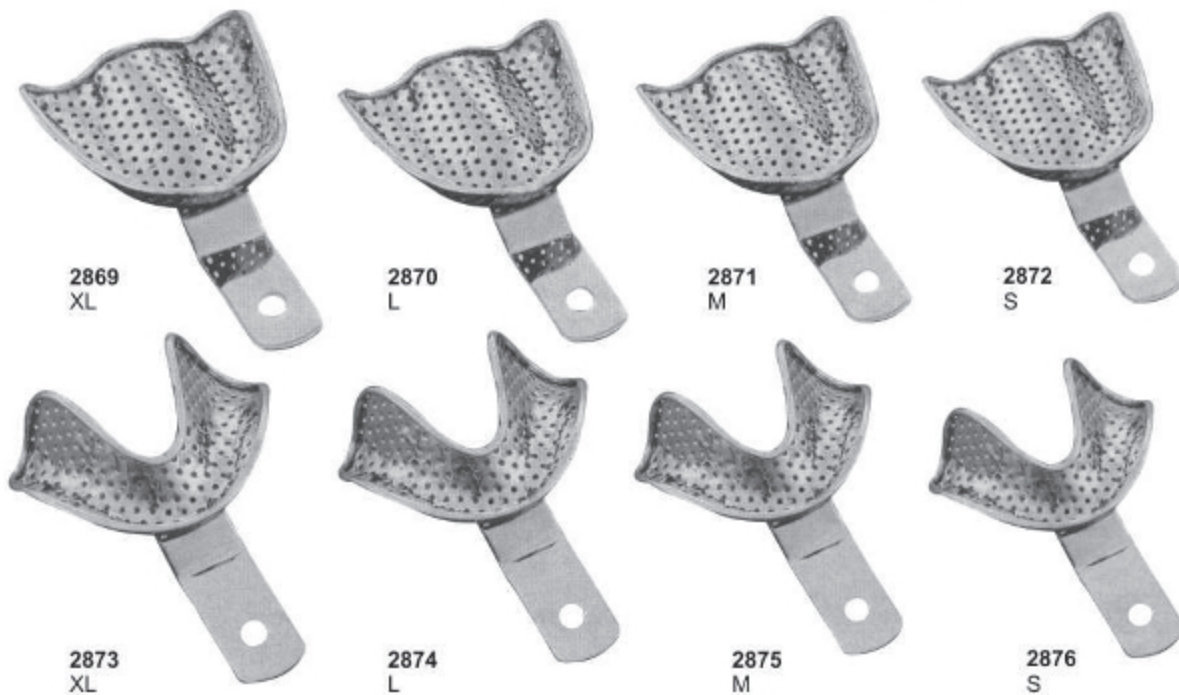

Perforated Full Denture Set of 8



## Impression Trays

Made of 18/8 Stainless Steel, Solid Set of 6

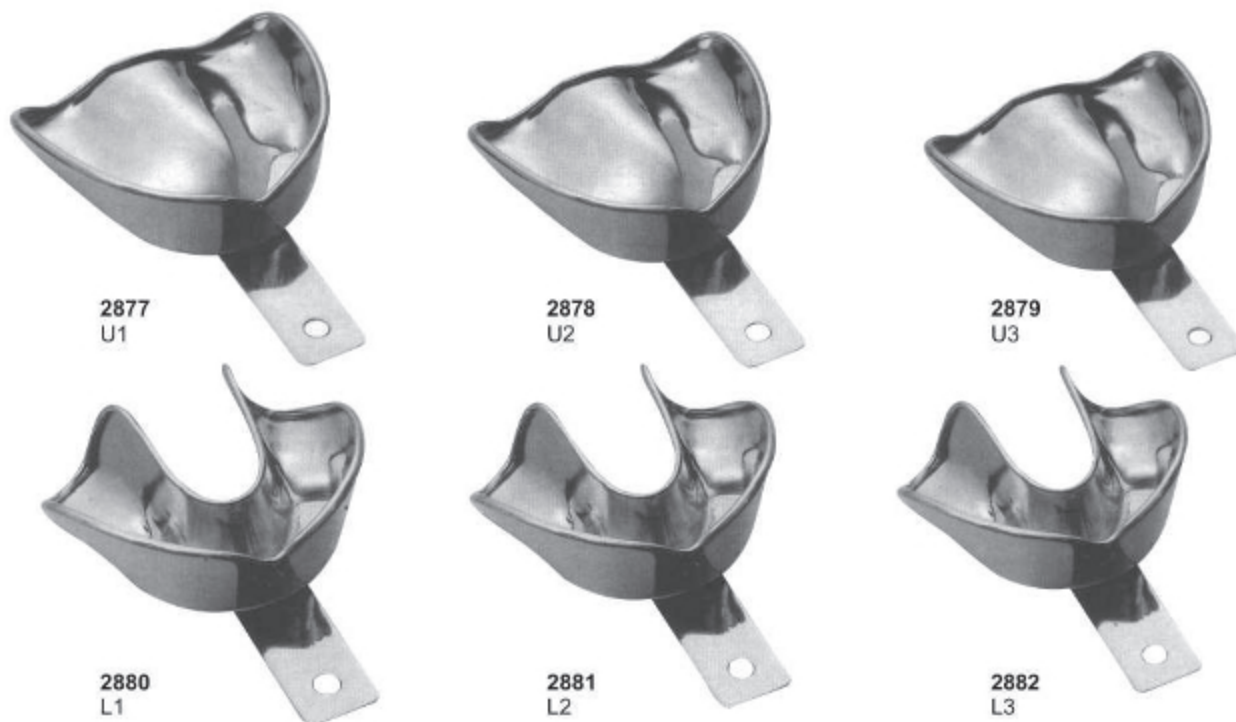

All The Above Impression Trays are Available in These 4 Sizes

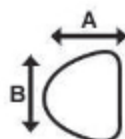

UPPER		U1	U2	U3
	A	67	64	57
B	81	71	70	

All Dimension are in mm

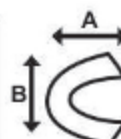

LOWER		L1	L2	L3
	A	60	57	54
B	81	79	76	

All Dimension are in mm

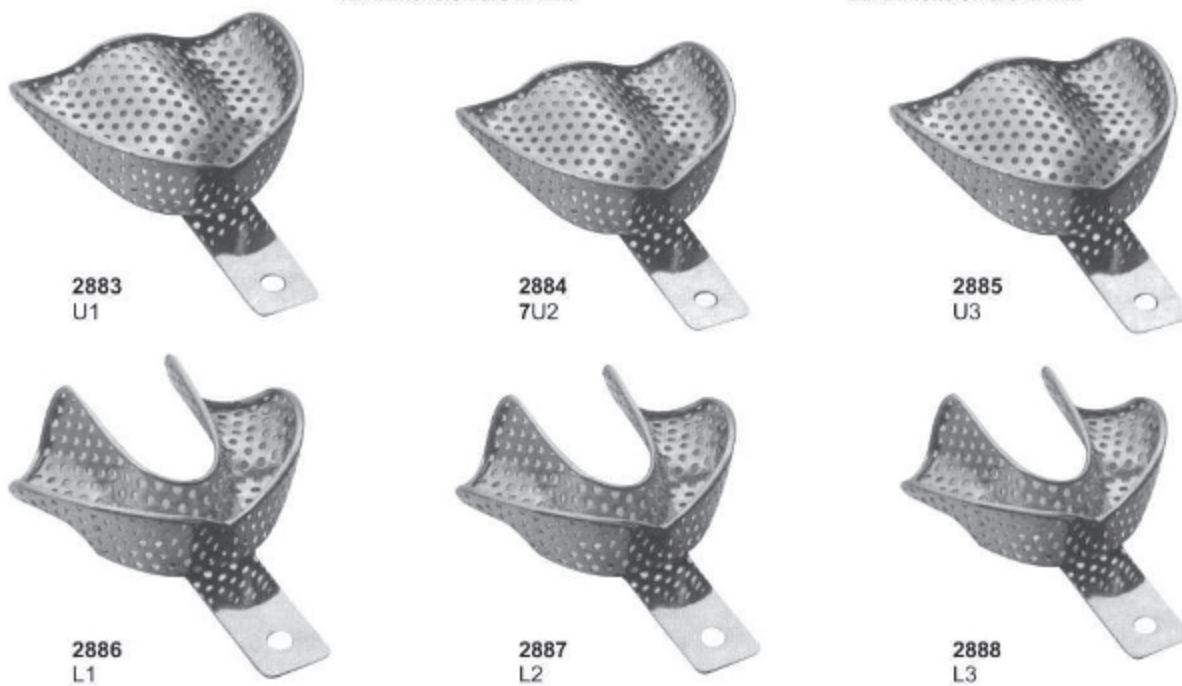

Perforated Set of 6

## Impression Trays

Made of 18/8 Stainless Steel, English Pattern Set of 8

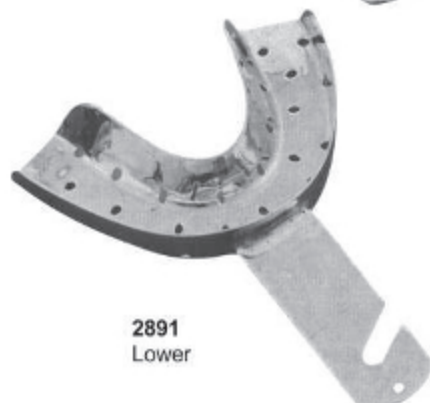
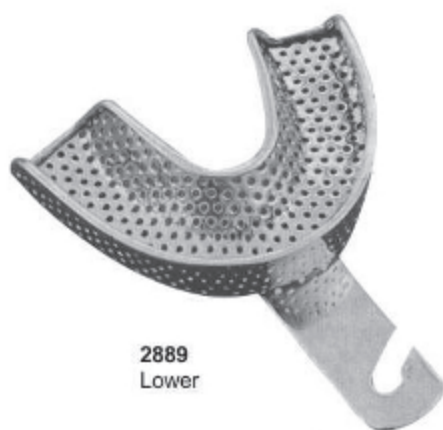

All The Above Impression Trays are Available in These 4 Sizes

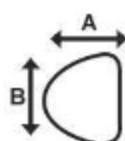

UPPER	Size	A	B	C
	0	67	50	12
	1	72	51	13
	2	78	55	15
	3	80	58	15

All Dimension are in mm

LOWER	Size	A	B	C
	0	70	50	14
	1	77	51	15
	2	79	55	15
	3	80	60	17

All Dimension are in mm

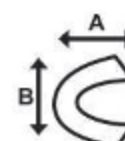

## Impression Trays

Made of 18/8 Stainless Steel, Solid Full Denture Set of 8

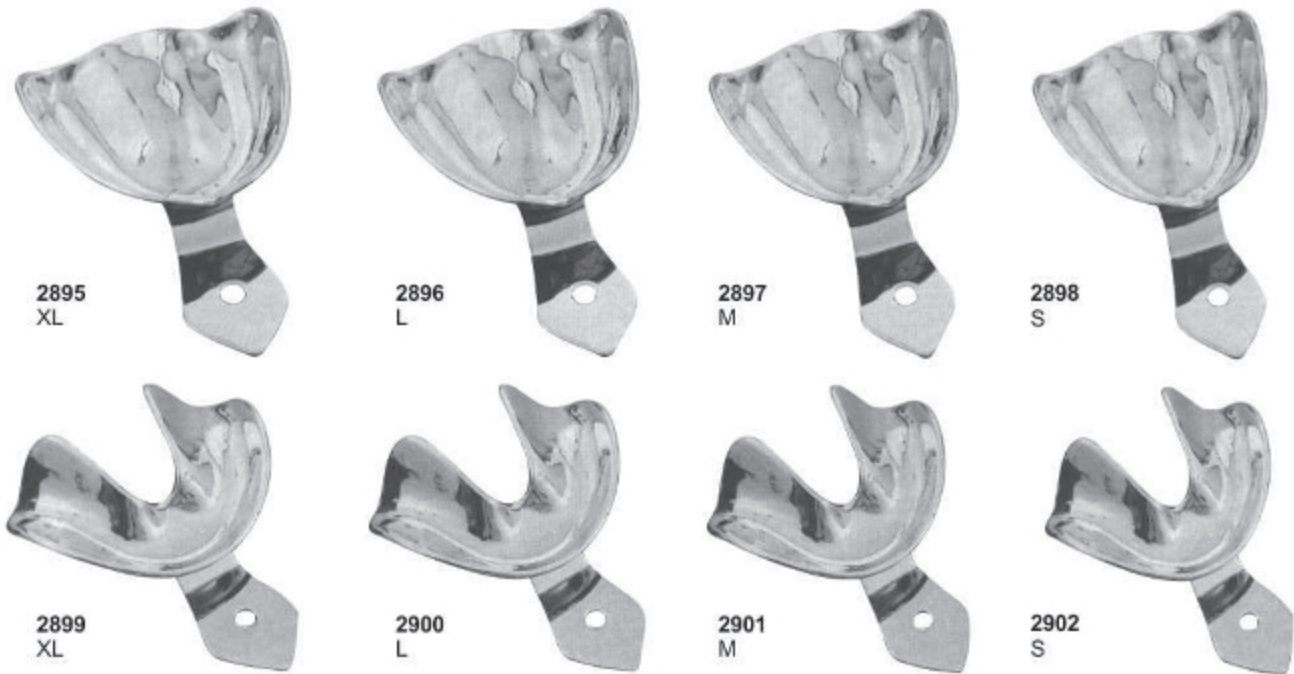

All The Above Impression Trays are Available in These 4 Sizes

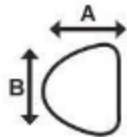

UPPER		XL	L	M	S
	A	70	67	64	60
B	79	76	70	73	

All Dimension are in mm

LOWER		XL	L	M	S
	A	64	64	60	57
B	86	70	73	70	

All Dimension are in mm

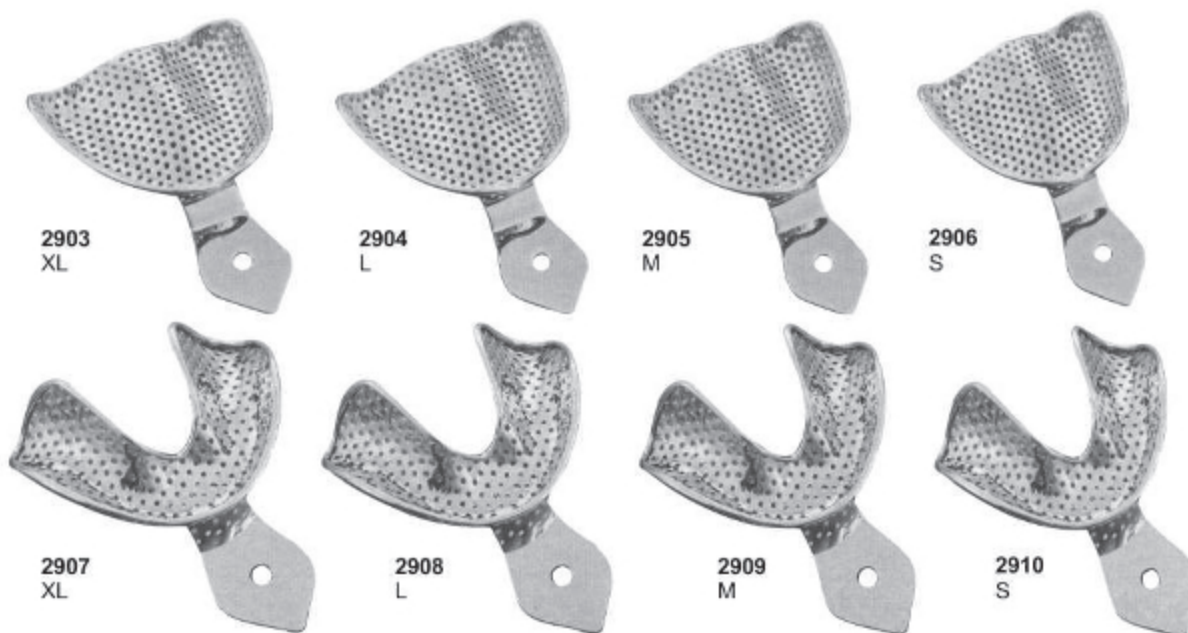
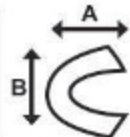

Made of 18/8 Stainless Steel, Perforated Full Denture Set of 8

## Impression Trays

Made of 18/8 Stainless Steel, Solid Full Denture Set of 8

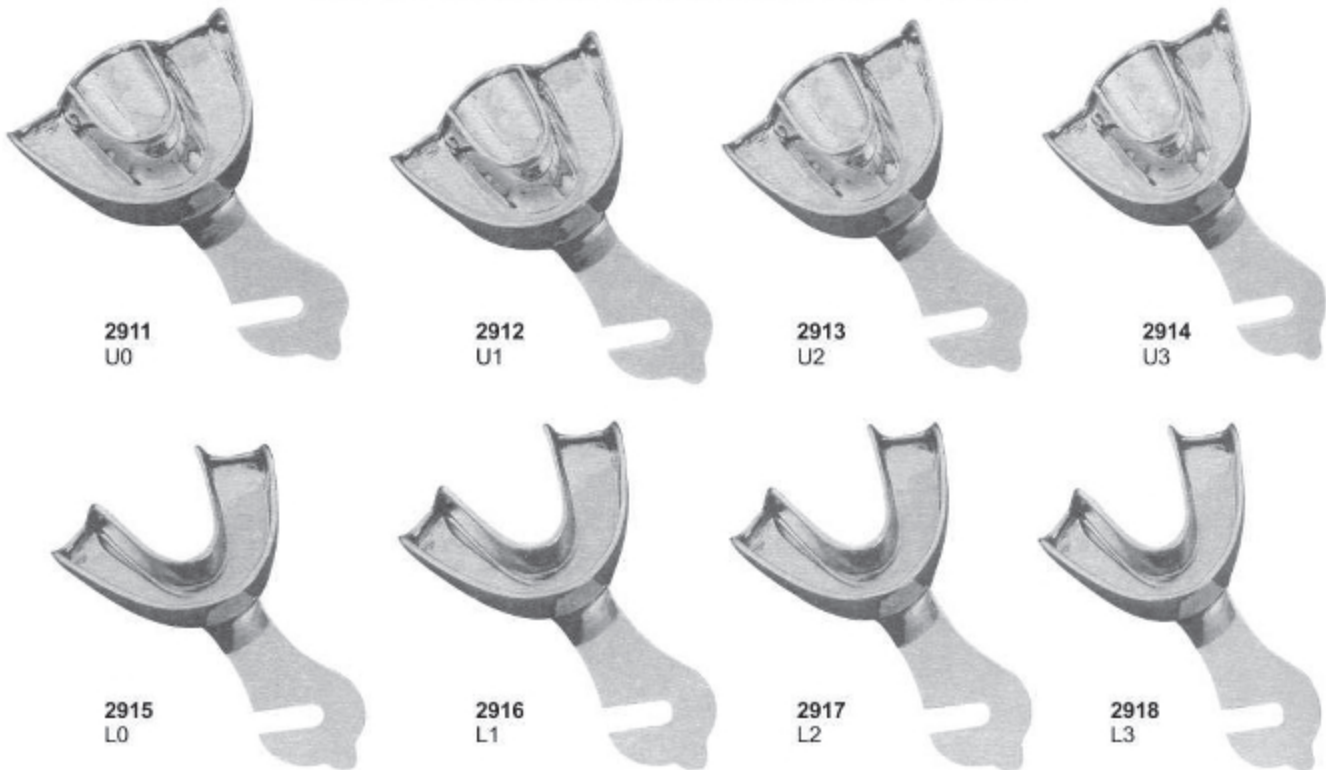

Upper Sizes: 0,1,2,3

Depth of Tray: 15,9 mm, Height of Plate: 12,5 mm

Lower Sizes: 0,1,2,3

Depth of Tray: 12,9 mm

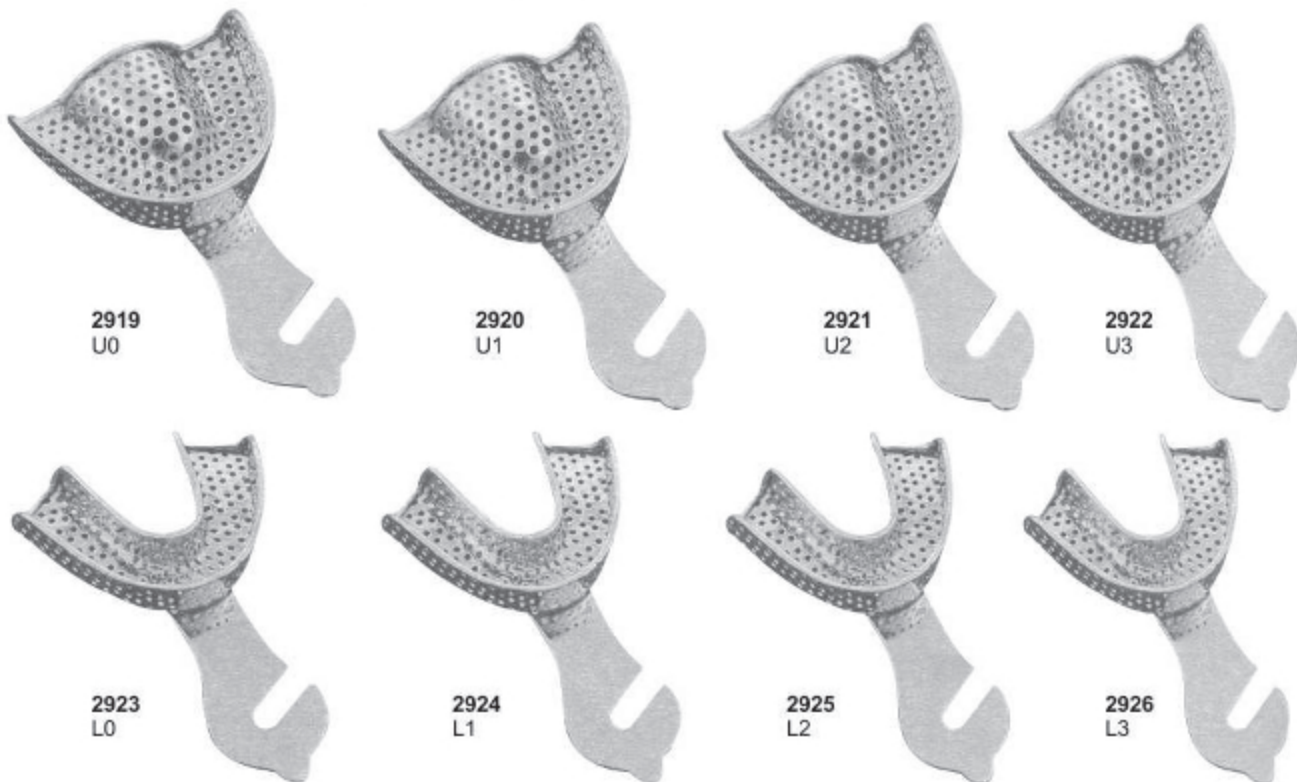

Made of 18/8 Stainless Steel, Perforated Full Denture Set of 8

## Impression Trays

### Impression Trays For Crown & Bridge Work

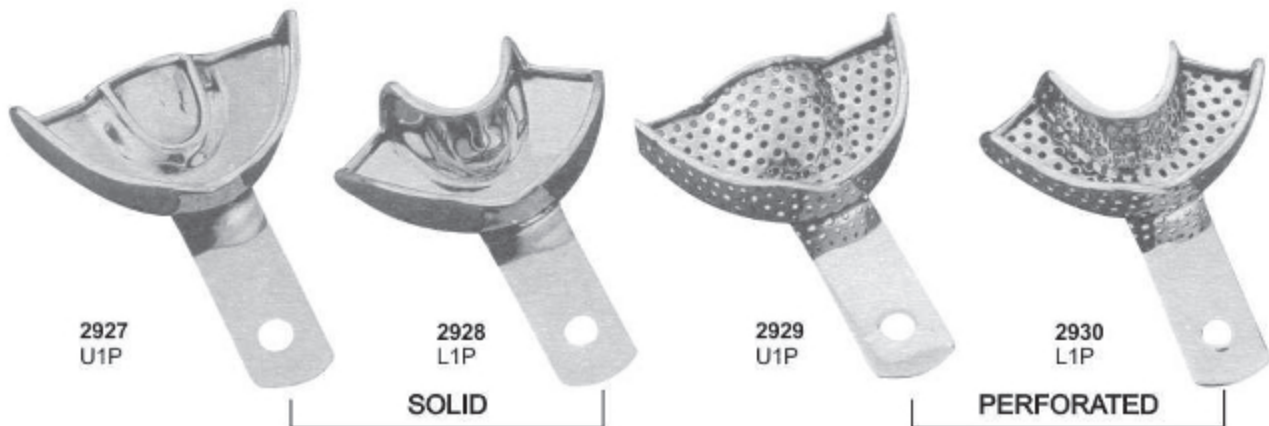

2931-A For upper right jaw  
For lower left jaw

2931-B For upper left jaw  
For lower right jaw

2931-C For upper right jaw  
For lower left jaw

2931-D For upper left jaw  
For lower right jaw

**Available in 4 sizes**

1.....44 mm  
2.....55 mm  
3.....60 mm  
4.....65 mm

**Available in 4 sizes**

1.....44 mm  
2.....55 mm  
3.....60 mm  
4.....65 mm

## Articulators



2934



2935



2936



2937



2939



2938

## Articulators

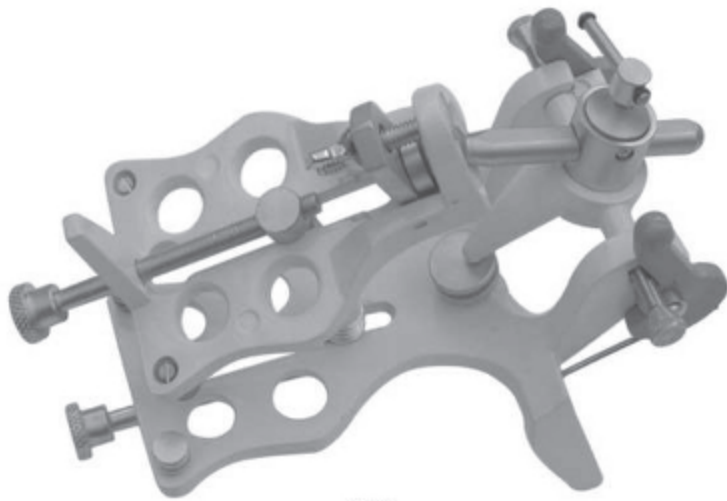

2940



2941



2942



2943

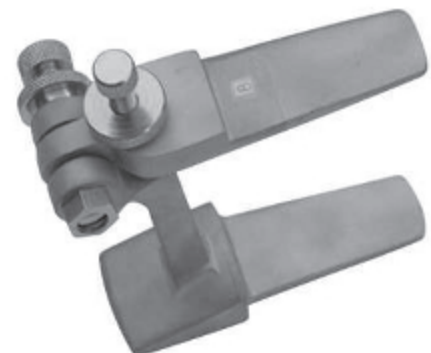

2944



2945



2946



2947

## Hollow Ware

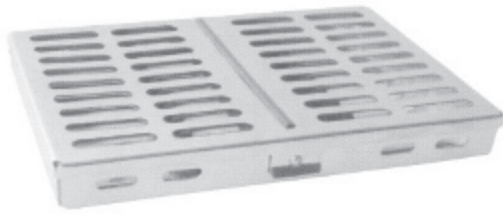

**2948**  
Instruments Tray of 20 Pcs

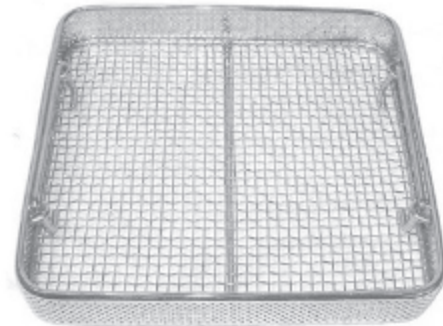

**2951**  
Instruments Riddle



**2949**  
Instruments Tray of 7 Pcs



**2949-A**  
Instruments Tray of 10 Pcs



**2950**  
Instruments Tray of 5 Pcs

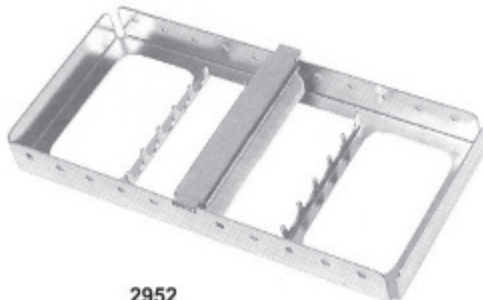

**2952**  
Instruments Tray of 5 Pcs

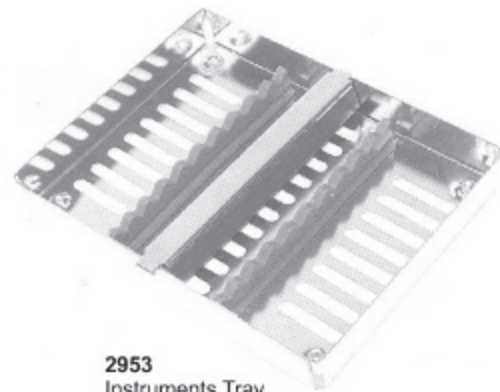

**2953**  
Instruments Tray



**2954**  
Instruments Tray  
Perforated



**2955**  
Instruments Tray  
Perforated Base



**2956**  
Instruments Tray  
Solid Base



## Hollow Ware



**2957**  
Pulpectomy Tray



**2958**  
Sterilizing Box  
Available Sizes:  
17x17x3 cm  
20x10x6 cm  
30x14x6 cm



**2959**  
Endo Tray Box



**2960**  
Finger Cup



**2961**  
Bur Box

**2962**  
Sterilizing Drum  
150x150mm  
175x175mm  
190x190mm  
200x140mm  
200x200mm  
240x120mm  
225x225mm  
240x240mm  
290x160mm



**2963**  
Sterilizing Drum  
280x240mm  
230x150mm  
300x250mm  
340x160mm  
350x250mm  
390x200mm  
380x300mm  
100x100mm  
150x120mm

## Sterilizing Boxes & Instruments Trays



**2964**  
Instruments Box



**2965**  
Instruments Box



**2966**  
Instruments Box



**2967**  
Instruments Sterilizer  
150x75 mm



**2968**  
Endodontic Box



**2969**  
Sterilizing Box  
320x120 mm



**2970**  
Instruments Tray



**2971**  
Instruments Tray



**2972**  
Instruments Tray  
(Perforated)



**2973**  
Instruments Tray  
Shallow(Mayo)



**2974**  
Scaler Tray  
20.0 x 10.0 x 1.5 cm

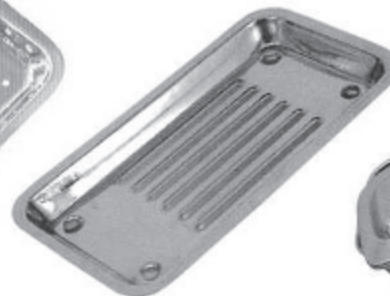

**2975**  
Scalers Tray



**2976**  
Scalers Tray

## Hollow Ware



**2982**  
Spittoons Mug



**2983**  
Spirit Burner With Wick  
Stainless Steel 18/10  
Capacity: 150 ml, 60 ml



**2984**  
Spirit Burners With Wick  
Stainless Steel 18/10  
Capacity: 70ml



**2985**  
Dressing Jar



**2986**  
Dressing Jar



**2987**  
Irrigator (Douch Can)



**2988**  
Measuring Jug

## Hollow Ware



**2989**  
Sponge Bowl



**2990**  
Wash Basin  
300mm-350mm-400mm



**2994**  
Kick Bucket With Trolley



**2991**  
Sponge Bowl



**2992**  
Gallipot



**2993**  
Medicine Cup



**2995**  
Kidney Tray Shallow  
150mm-200mm-240mm-300mm



**2996**  
Kidney Tray Without Lid  
150mm-200mm-250mm-300mm



**2997**  
Kidney Tray With Lid  
150mm-200mm-250mm-300mm

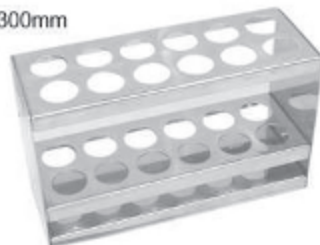

**2998**  
Tube Rack, Stainless Steel 18/10



**2999**  
Needle Case Rectangle  
Needle Case Round With Cover  
90x15



**3000**  
Dustbin Without Stand  
6-10-12 Ltr



**3001**  
Tube Rack, Round Model  
Stainless Steel 18/10



**3002**  
Dustbin Without Stand & Cap  
6-10-12 Ltr



**3003**  
Lotion Bowl With Lip  
40-60-80-100-120-150-180-200mm

## Scissors with Tungsten Carbide Inserts



**3004**  
Standard



14,5cm  
16,5cm  
18,5cm



**3005**  
Standard

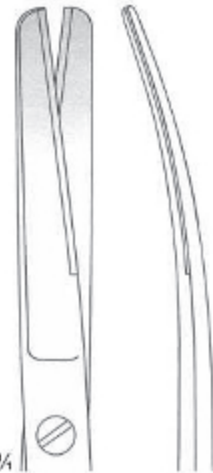

14,5cm  
16,5cm  
18,5cm



**3006**  
Standard



14,5cm  
16,5cm  
18,5cm



**3007**  
Standard



14,5cm  
16,5cm  
18,5cm



**3008**  
Standard



14,5cm  
16,5cm  
18,5cm



**3009**  
Standard



14,5cm  
16,5cm  
18,5cm

## Scissors with Tungsten Carbide Inserts

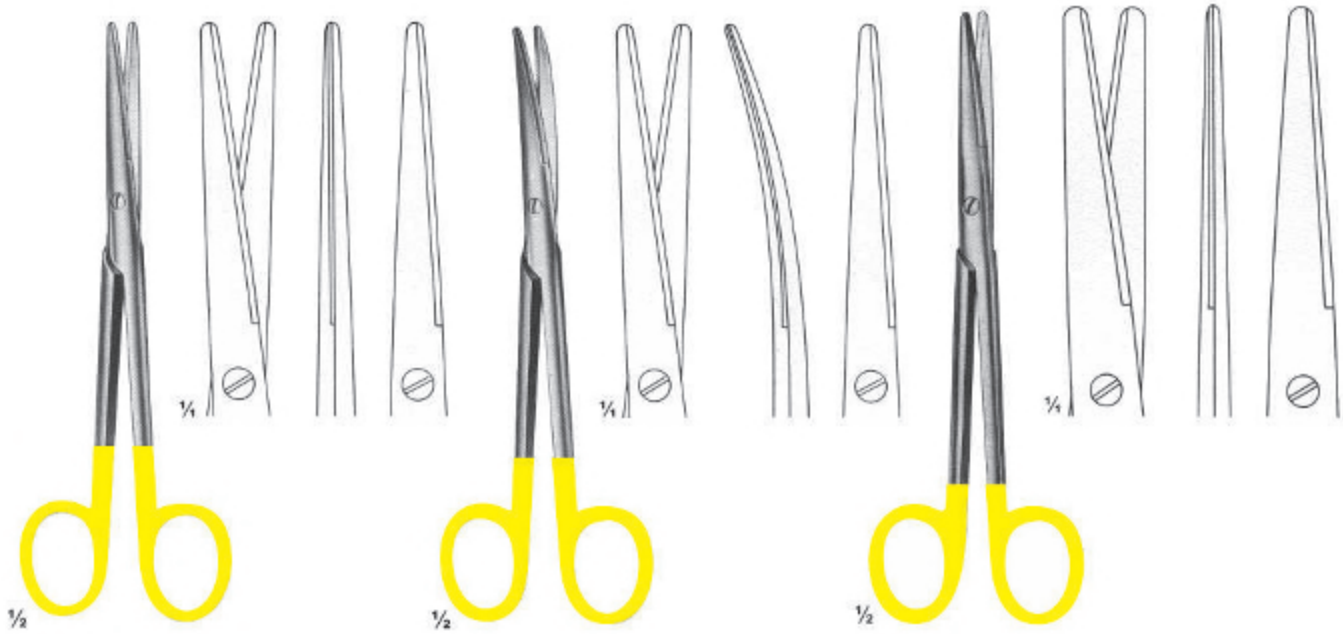

**3010**  
MAYO-LEXER  
Straight  
16 cm

**3011**  
MAYO-LEXER  
Curved  
16 cm

**3012**  
LEXER  
Straight  
16, 21 cm

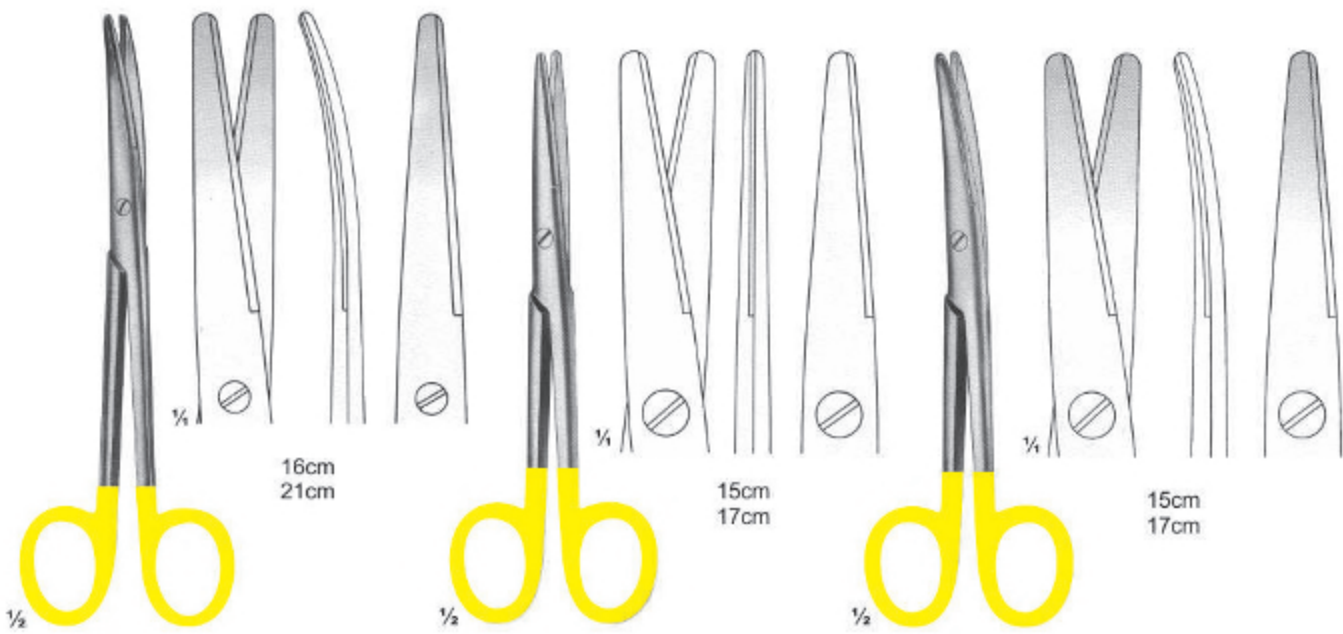

**3013**  
LEXER  
Curved  
16, 21 cm

**3014**  
MAYO-STILLE  
Straight  
15, 17 cm

**3015**  
MAYO-STILLE  
Curved  
15, 17 cm

## Scissors with Tungsten Carbide Inserts

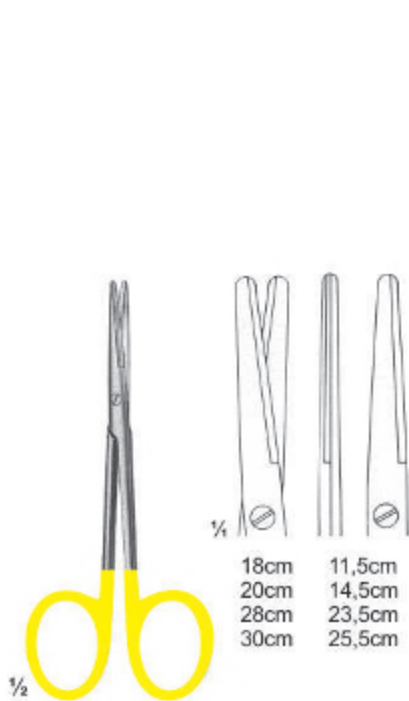

18cm  
20cm  
28cm  
30cm

11,5cm  
14,5cm  
23,5cm  
25,5cm

**3016**  
METZENBAUM  
Straight



11,5cm  
23cm

14,5cm  
25cm

**3017**  
METZENBAUM  
Curved

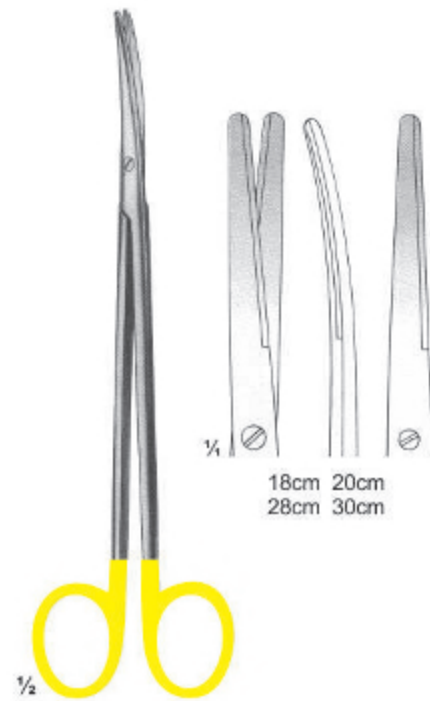

18cm  
20cm  
28cm  
30cm

**3018**  
METZENBAUM  
Curved



14cm  
23cm

18cm  
25cm

20cm  
28cm

**3019**  
METZENBAUM FINO  
Straight



14cm  
23cm

18cm  
25cm

20cm  
28cm

**3020**  
METZENBAUM FINO  
Curved

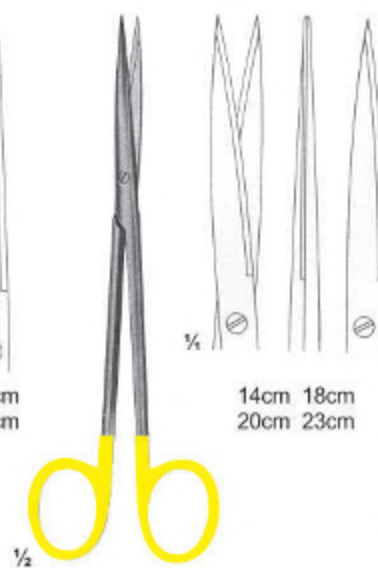

14cm  
20cm

18cm  
23cm

**3021**  
METZENBAUM FINO  
Sharp



**3022**  
BRUNS  
235 mm

## Scissors with Tungsten Carbide Inserts

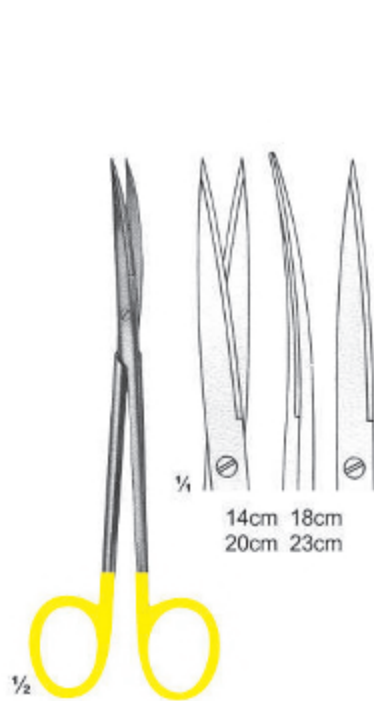

**3023**  
METZENBAUM FINO

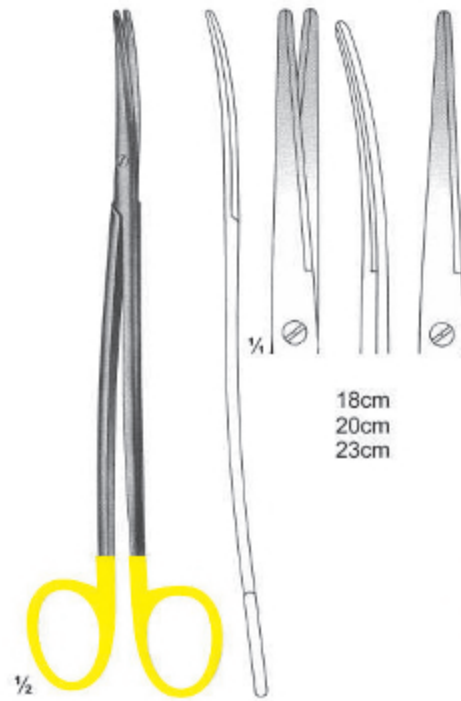

**3024**  
METZENBAUM FINO

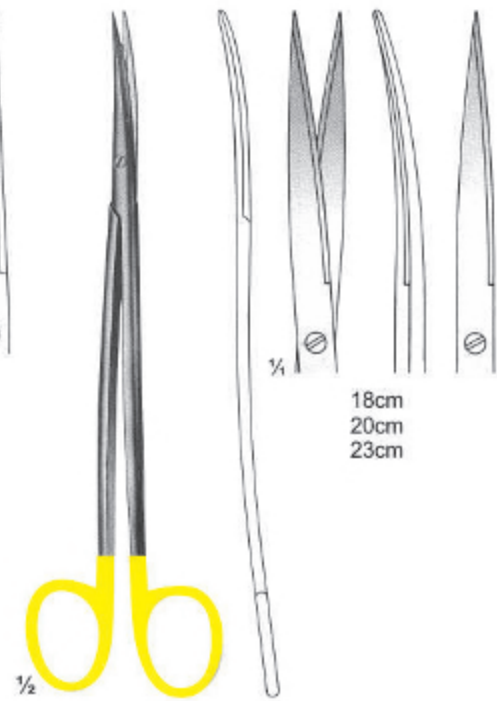

**3025**  
METZENBAUM FINO

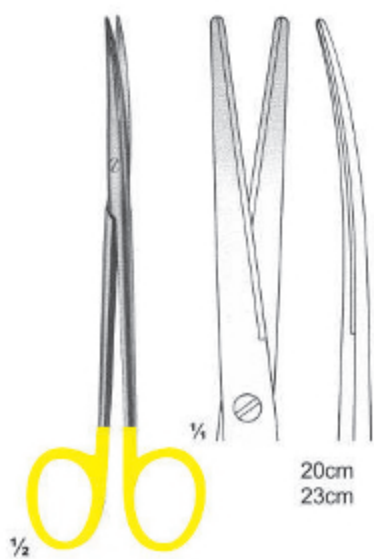

**3026**  
METZENBAUM FINO

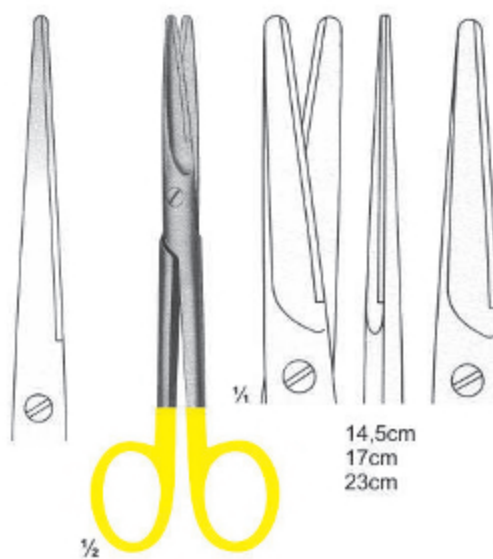

**3027**  
MAYO  
Straight

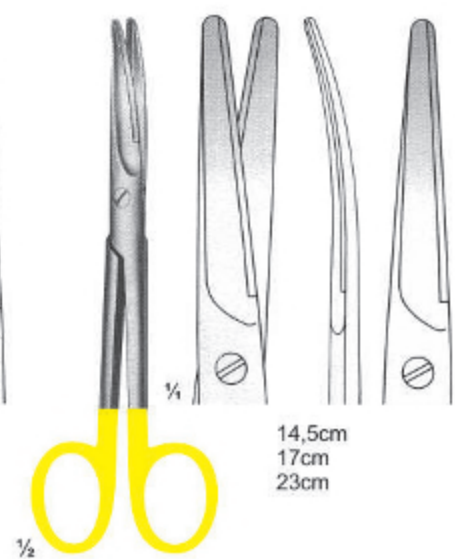

**3028**  
MAYO  
Curved



## Scissors with Tungsten Carbide Inserts

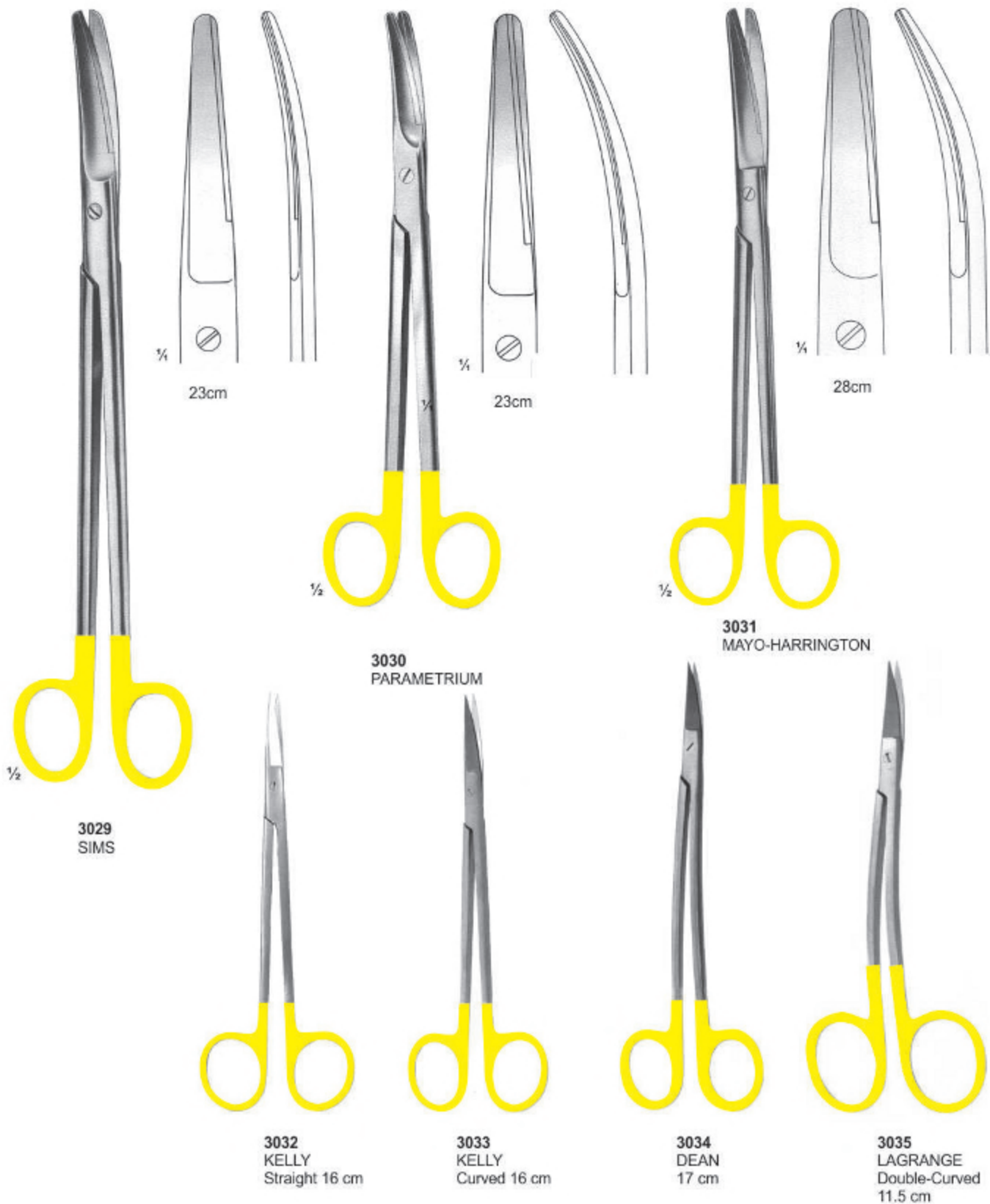

## Scissors with Tungsten Carbide Inserts

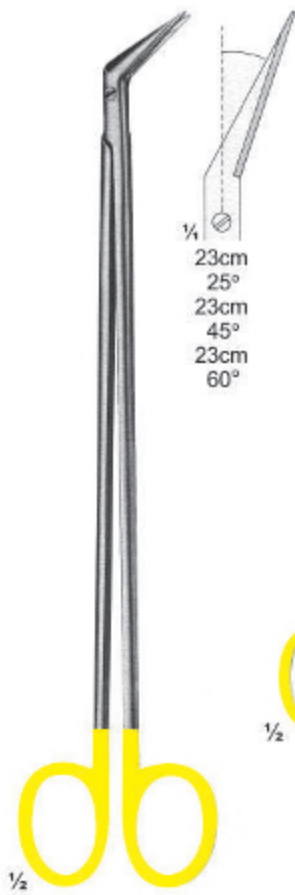

**3036**  
DE-BAKEY



**3037**  
DE-BAKEY

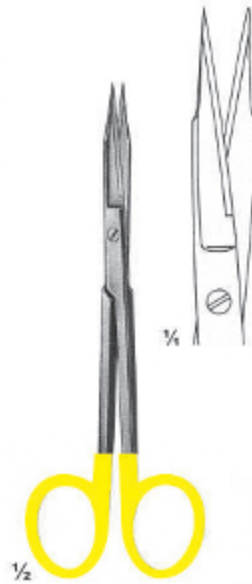

**3038**  
GOLDMAN FOX  
13 cm



**3039**  
GOLDMAN FOX  
Double-Curved  
13 cm

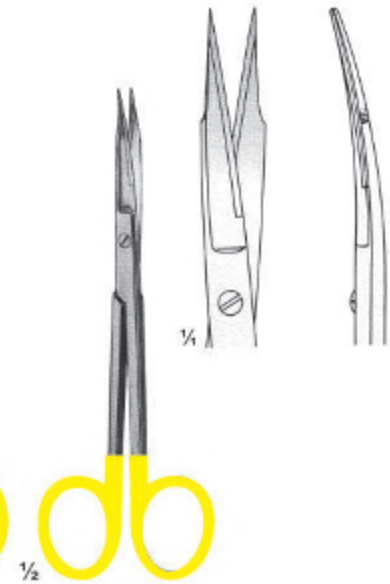

**3040**  
GOLDMAN FOX  
13 cm

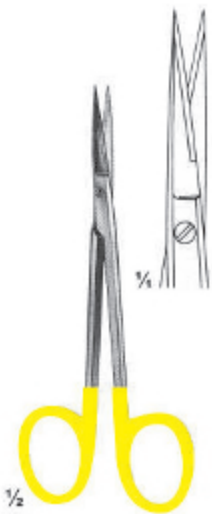

**3041**  
Fine Scissors  
Straight  
11, 5 cm

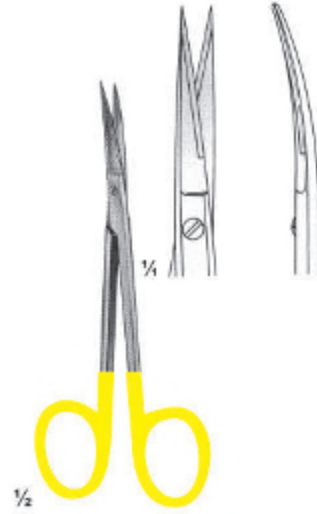

**3042**  
Fine Scissors  
Curved  
11, 5 cm



**3043**  
Fine Scissors  
Angled  
11, 5 cm



**3044**  
RAGNELL  
Curved  
12 cm

## Scissors & Dissecting Forceps with T.C. Inserts

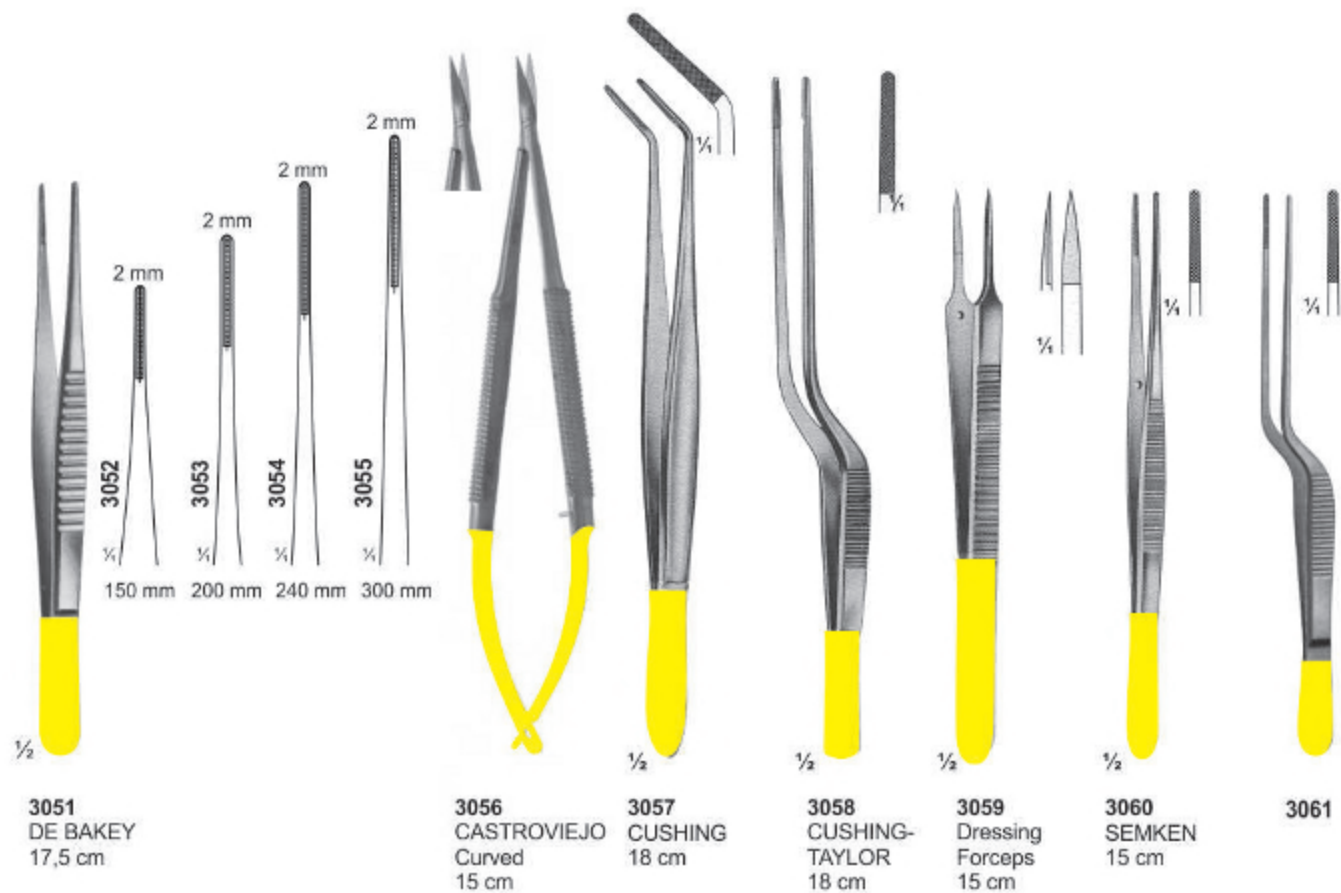
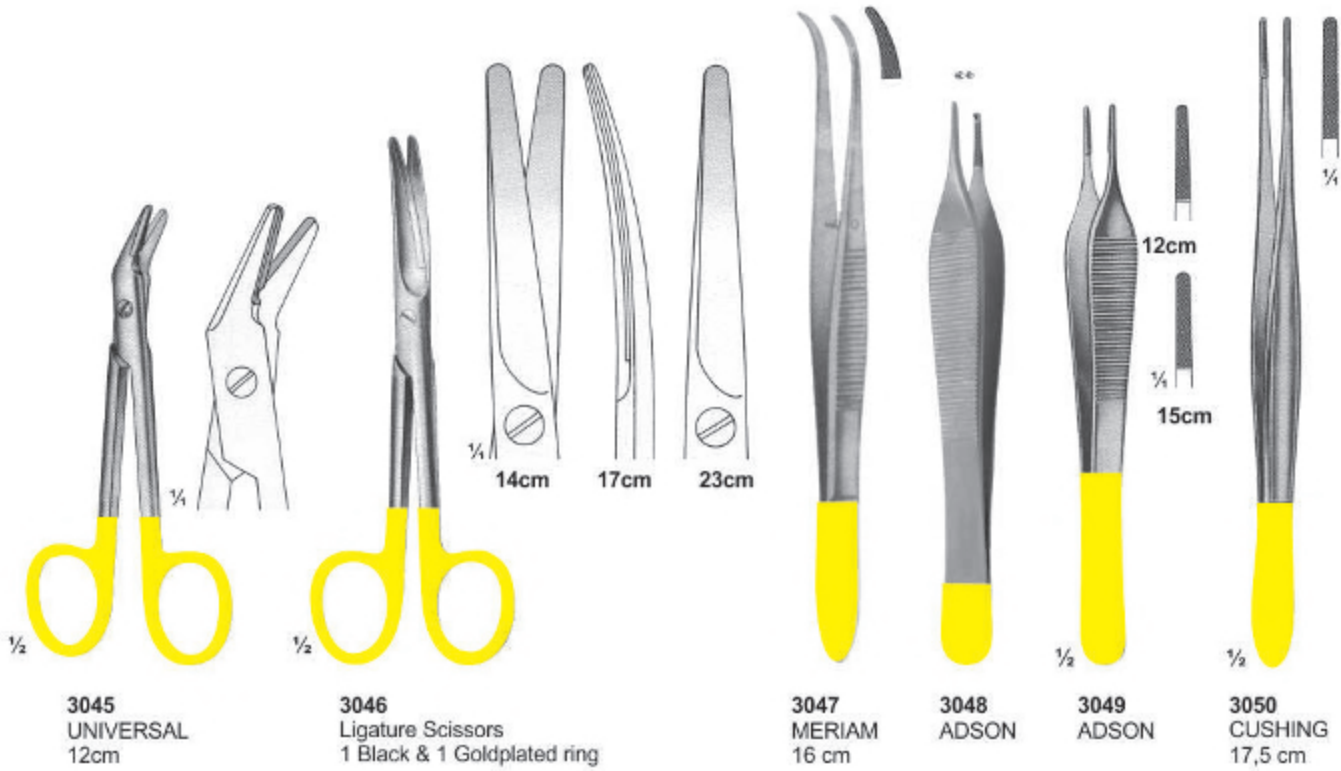

## Dissecting & Needle Holders T.C. Instruments

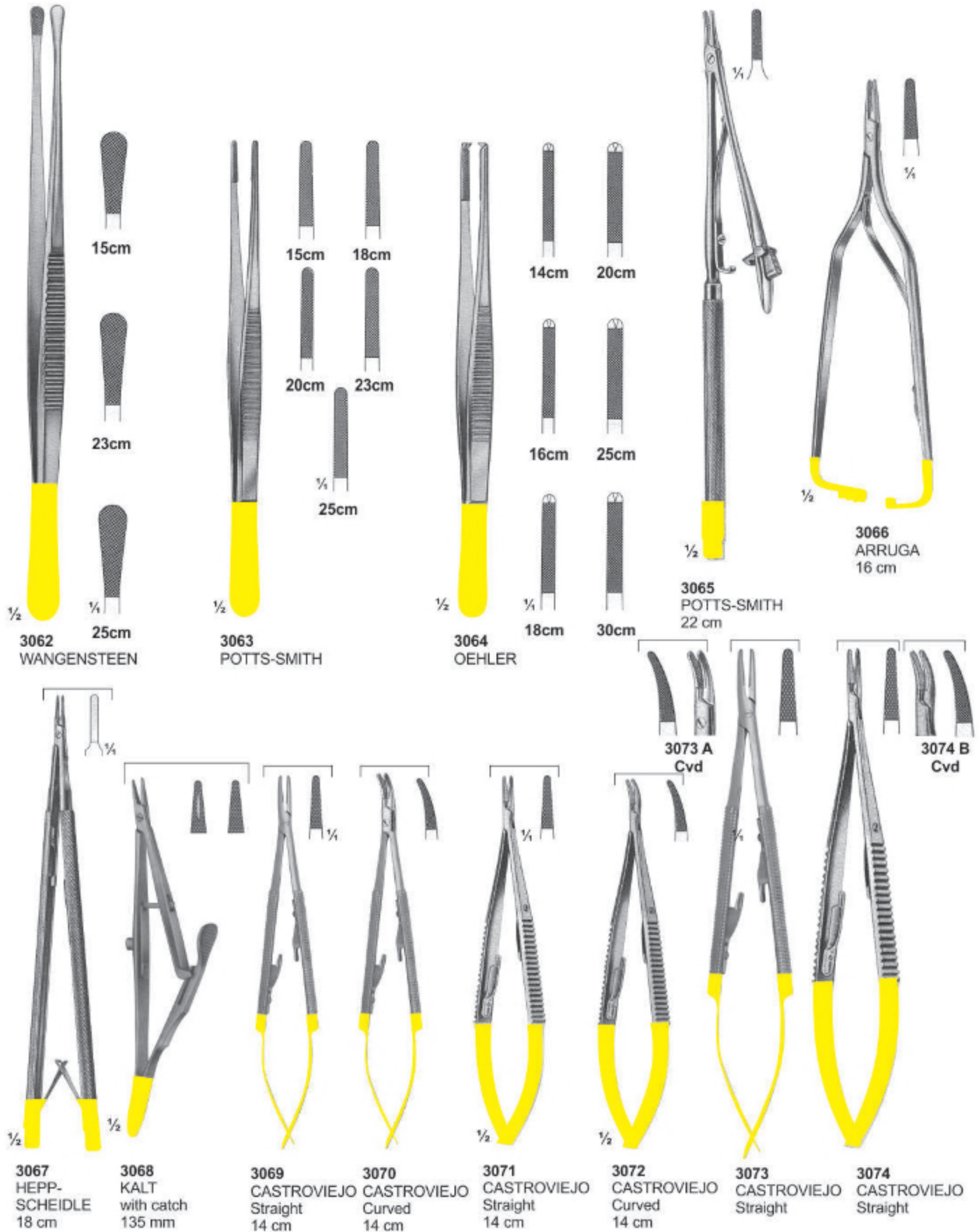

## Needle Holders with T.C. Inserts

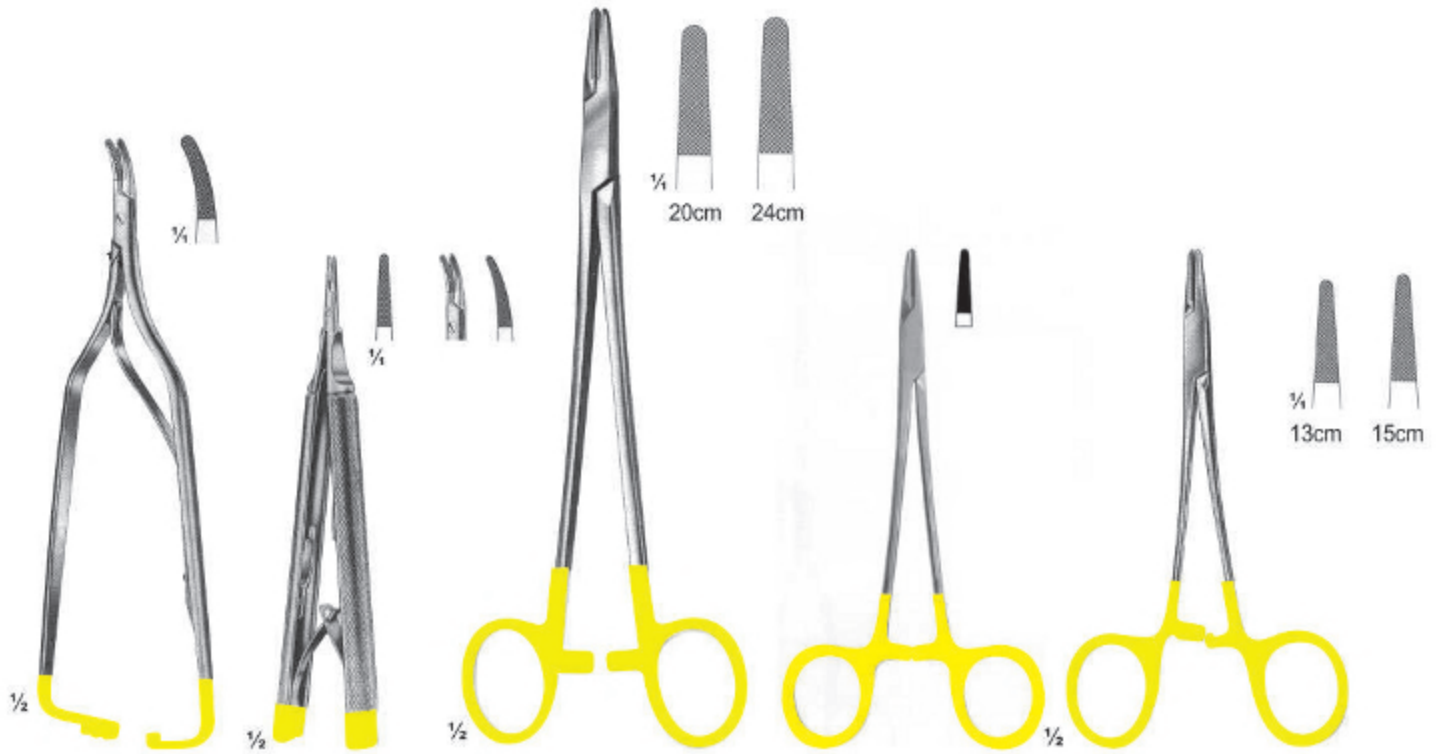

**3075**  
ARRUGA  
Curved  
16 cm

**3076**  
CASTROVIEJO  
13 cm

**3077**  
HEGAR  
20,24 cm

**3078**  
SMOOTH TIP  
15 cm

**3079**  
HALSEY  
13,15 cm

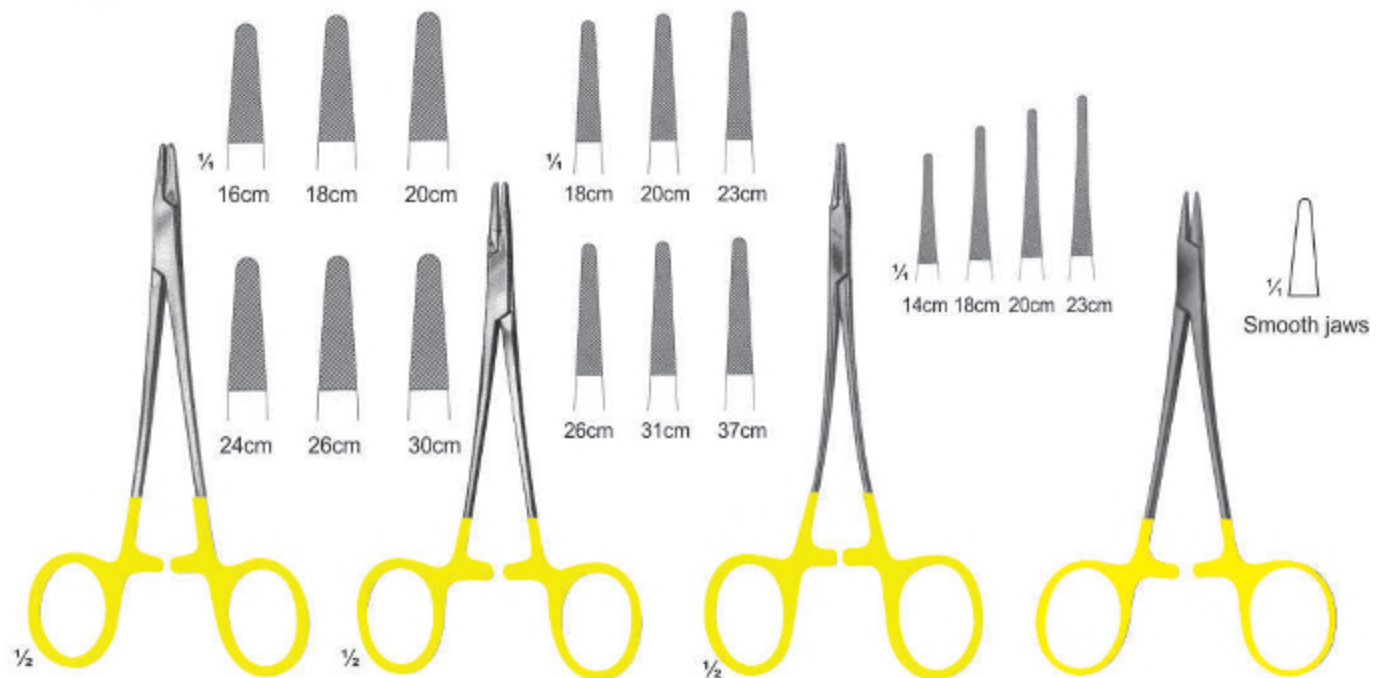

**3080**  
MAYO-HEGAR

**3081**  
DE BAKEY

**3082**  
HEGAR-VASCULAR

**3083**  
WEBSTER  
125 mm

## Needle Holders with Tungsten Inserts

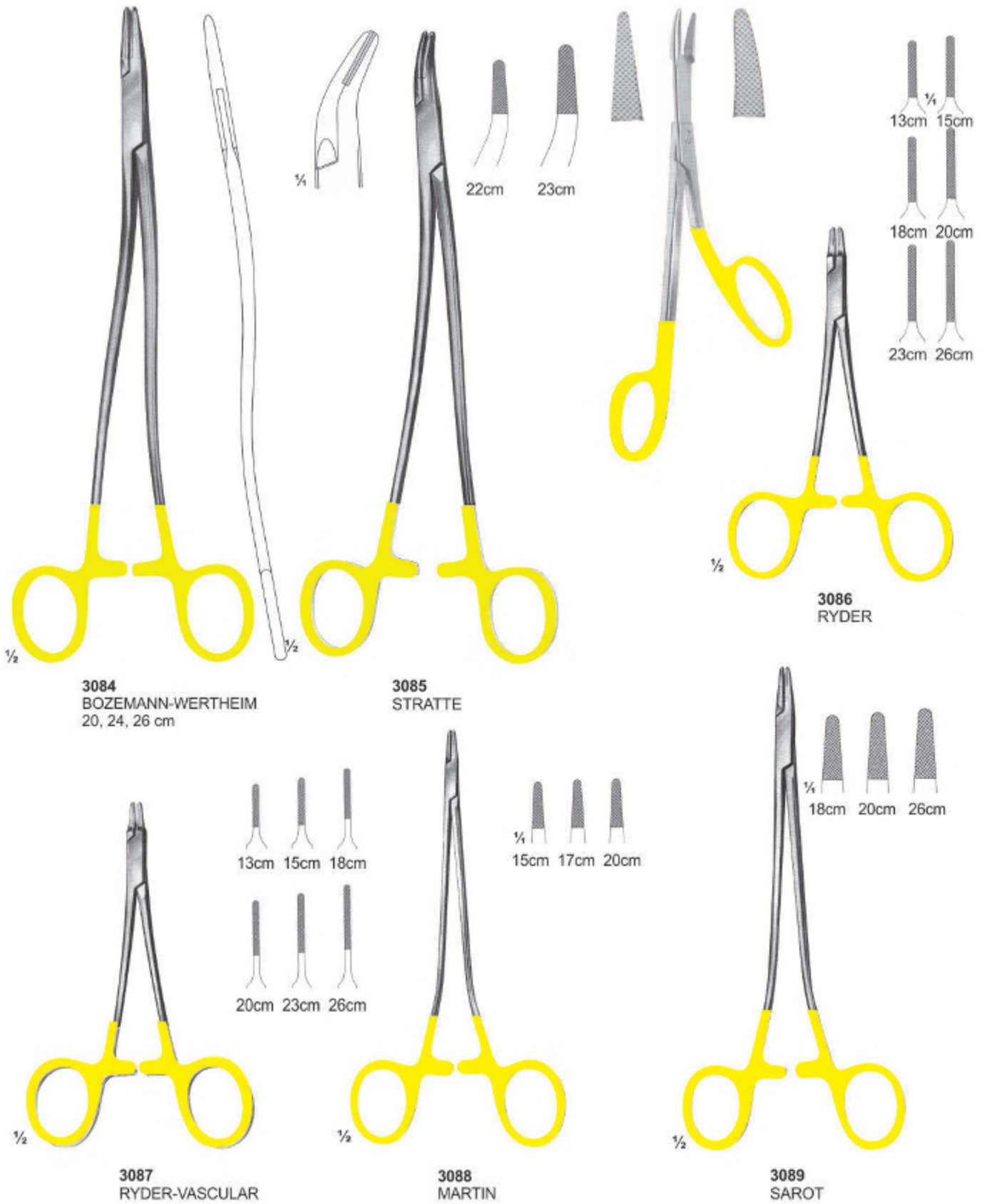

## Needle Holders with Tungsten Inserts

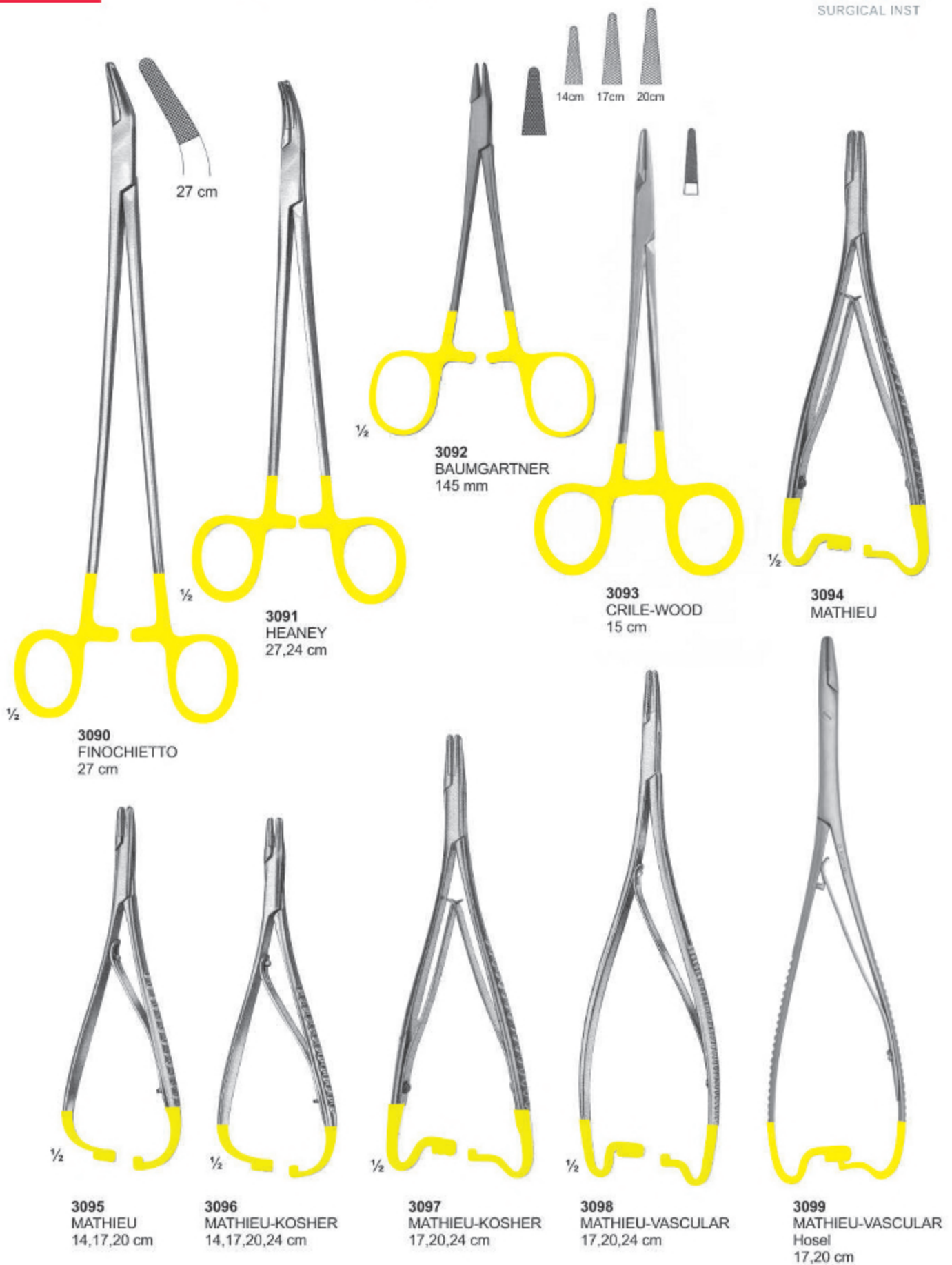

## Needle Holders with T.C. Inserts



**3100**  
MATHIEU-RYDER  
17,20,24 cm

**3101**  
Hosel  
Curved  
20 cm

**3102**  
LICHTENBERG  
20 cm

**3103**  
LANGHALS  
20,25 cm

**3104**  
LICHTENBERG  
20,25 cm



**3105**  
LUEHTY-BECK  
20,25 cm



**3106**  
LUEHTY-BECK  
20,25 cm



**3107**  
LANGENBECK  
18,20,23 cm

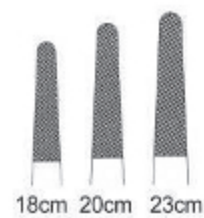

**3108**  
LANGENBECK  
18,20,23 cm



## Wire Cutting Plier with T.C. Inserts



**3109**  
**TOENNIS**  
Elastic pattern for  
dura-or intestinal suture  
180 mm



**3110**  
**Cutting Plier**  
12 cm

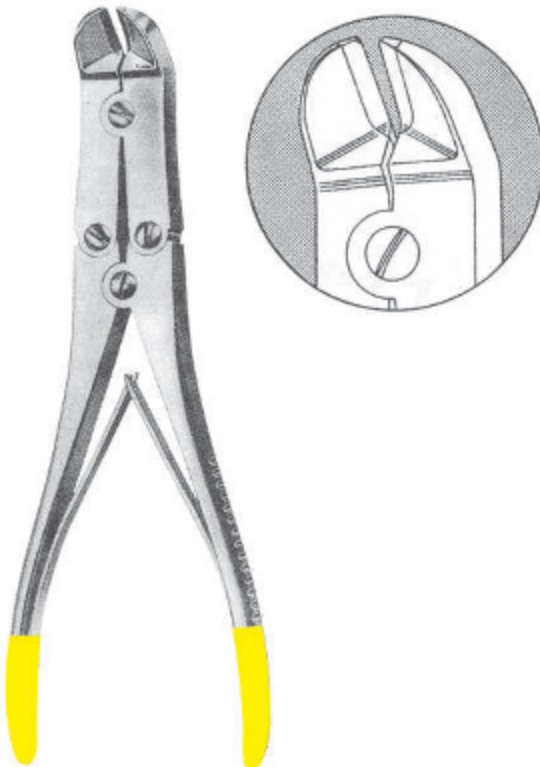

**3111**  
**MULLAR CLAUS**  
22 cm



**3112**  
**Plier**  
17.5 cm

# Alphabetical Index

<b>A</b>			
Adams, Pliers	174	Bone Gauge,	144
Aderer, Pliers	174	Bone Mill Forcep,	139
Adson, Forceps	158,207	Bone Pluggers,	140
Adson, Tweezers	151	Bracket, Gauge	144
Ainsworth, Rubber Dam Punch	147	Buser, Elevator	52
Albee	143		
Albrecht, Tweezers	155	<b>C</b>	
Allen, Tweezers	155	Carvers	102,103
Allis, Tissue Forceps	158	Castroviejo, Needle Holder	181,208,209
Amalgam Applicators	97	Castroviejo, scissors	186
Amalgam Condensers	97	Castroviejo, Gauge	144
Amalgam Pluggers	97	Castroviejo, Sclerer Marker	144
Amalgam Carriers	145	Cement Instruments	118,119,121
Amalgam Guns	145	Cement Spatulas	120,122
Andresen, Pliers	175	Chisels	103
Andrews, Tongue Depressor	160	Chompret, Elevator	63
Angle, Pliers	169,174	Cleveland, Rongeurs	177,178
Apical, Elevator	57,63	College, Tweezers	152,154
Arruga, T.C. Needle Holder	208,209	Collier, Needle Holder	180
Articulators	194-195	Collin, Retractor	162
Aspirating Syringes	149	Columbia, Curettes	110,111,116
Allen 9A, Elevator	50	Composite Placement	104,105
		Con Scodellino, Wax Knives	126
		Cord Packers	95
		Cottle, Scissors	184
		Coupland, Elevator	58
		Crane-Kaplan	128
		Crile, Forceps	157
		Crile, Needle Holder	181
		Crile-Wood, Needle Holder	180
		Crown Instruments	135,136
		Crown Removers	134,135
		Crown Shell, Pliers	166
		Cryer, Elevator	55,58,69
		Cushing , T.C. Forceps	207
		Cushing, Tweezers	151
		Cushing-Taylor , T.C. Forceps	207
		<b>D</b>	
		De Bakey , T.C. Forceps	207
		De Bakey, Scissors	184,186,206
		De Bakey, T.C. Needle Holder	209
		De La Rosa, Pliers	169
		Deaver, Scissors	184
		Denhart, Mouth Gag	160
		Derf, Needle Holder	180
		Disposable Products	117
		Dr.Sader, Elevator	69
		Dressing Forceps	207
		Dean Scissors	186,205
<b>B</b>			
Baby-Allis, Tissue Forceps	158		
Band Removing Pliers	170		
Bane, Rongeurs	179		
Barnhart, Curettes	110,116		
Barry, Elevator	66,69		
Baum Gartner, Needle Holder	180,211		
Bee Be, Scissors	186		
Bein, Elevator	54,61		
Beyer, Rongeurs	179		
Bird Beak Pliers	167		
Blumenthan, Rongeurs	176		
Boley Gauge	143		
Bone Curettes	129		
Boynton, Needle Holder	181		
Bozemann-Wertheim, T.C. Needle Holder	210		
Bracket, Pliers	170		
Brewer, Rubber Dam Instruments	147		
Brown, Tissue Forceps	158		
Brown-Adson, Tissue Forceps	158		
Bruns, T.C. Scissors	203		
Buchs, Retractor	162		
Burnishers	99-100		
Ball Chain	146		
Boley Gauge,	143		



# Alphabetical Index

Langenbeck, T.C. Needle Holder	212	Mini-Blumenthan, Rongeurs	176
Langer, Curettes	110,116	Molt, Elevator	50
Langhals, T.C. Needle Holder	212	Molt, Mouth Gag	160
Lecluse, Elevator	65	Molt 9, Elevator	50
Lessmann, Wax Knives	126	Morrison, Elevator	56
Lexer, T.C. Scissors	202	Mouth Mirrors with Handles	73
Lichtenberg, T.C. Needle Holder	212	MSY, Pliers	175
Ligature, T.C. Scissors	207	Mullar Claus, Wire Cutting Pliers T.C.	213
Lip & Cheek Retractors	161,162		
Lister, Scissors	184	<b>N</b>	
Littauer, Scissors	186	Nance, Pliers	168,169,174
Littler, Scissors	184	Napkin Holders	146
Locklin, Scissors	186	Neivert, Needle Holder	180
London Hospital, Elevator	62	Nelson-Metzenbaum, Scissors	185
London-College, Tweezers	154,155	Non Chill	146
Lucae, T.C. Forceps			
Luehty-Beck, T.C. Needle Holder	212	<b>O</b>	
Lwanson, Crown Gauge	143	O'Brien, Pliers	168
Lagrange, Scissors	186,205	Obturation Instruments	88
Littaure, Scissors	186	Ochsenbein	128
Lwanson, Crown Gauge	143	Ordan, knife	114
		Oehler, T.C. Forceps	208
<b>M</b>		Olsen-Hegar, Needle Holder	180
Martin, T.C. Needle Holder	210	Optical Pliers	168
Mathieu, Needle Holder	181,211	Orthodontic Cutters, T.C.	172
Mathieu-Kosher, T.C. Needle Holder	211	Orthodontic Distal & Cutters	173
Mathieu-Ryder, T.C. Needle Holder	212	Orthodontic Pliers, T.C.	171
Mathieu-Vascular, T.C. Needle Holder	211	Ott, Elevator	62
Mayo Harrington, T.C. Scissors	205		
Mayo, Scissors	185,204	<b>P</b>	
Mayo-Hegar, Needle Holder	181	Parametrium, T.C. Scissors	205
Mayo-Hegar, T.C. Needle Holder	209	Partsch, Bone Chisels	133
Mayo-Lexer, T.C. Scissors	202	Partsch, Bone Mallet	133
Mayo-Stille, T.C. Scissors	202	Pean, Forceps	157
Mayo-Stille Scissors	185	Peeso, Pliers	166,175
Mc Kellops, Pliers	175	Peets, Forceps	157
Mccalls, Curettes	110,111,116	Perry, Tweezers	151
Mcindoe, Tweezers	151	P.K. Thomas,	96
Mead, Bone Mallets	133	Pich,	98
Mead, Elevator	64	Pluggers,	98
Mead, Rongeurs	179	Prichard, Elevator	50
Meriam, T.C. Forceps	207	Plastic Handle Elevators	70
Meriam, Tweezers	153,155	Polokoff, Bone File	131
Metzenbaum Fino, T.C. Scissors	203,204	Pott, Elevator	51
Metzenbaum, Scissors	185,203	Potts-Smith, T.C. Forceps	208
Micro Surgery Set	182	Potts-Smith, T.C. Needle Holder	208
Micro-Adson, Tweezers	151	Probes	82-85,91,94
Micro-Friedman, Rongeurs	178		
Middledorpf Retractor	162	<b>Q</b>	
Miller, Articulating Forceps	147	Quinby, Scissors	183
Miller, Bone Files	130		

# Alphabetical Index

<b>R</b>			
Ragnell , T.C. Scissors	206	Toennis-Adson, Scissors	184
Retainers, Bands	146	Toennis, Tissue Retractor	164
Reynolds, Pliers	169,174	Towel Clamps, Napkin Holders	159
Root Planning Curettes	115	Tweed, Pliers	168
Root splinter forceps	35	Telescope, Crown Plier	136
Roux, Retractor	162	Traymann, Crown Remover	128
Rubber Dam Clamps	148		
Rubber Dam Holder	147	<b>U</b>	
Rule, Curette	110	Universal , T.C. Scissors	207
Russian, Tissue Forceps	158	Universal, Pliers	174
Ryder, T.C. Needle Holder	210	Universal, Elevator	135
Ryder-Vascular, T.C. Needle Holder	210	Utility Plier	165
		<b>V</b>	
<b>S</b>		Vernier, Measuring Instruments	143
Sarot, T.C. Needle Holder	210	Vernier Gauge	143
Scalers	75-79		
Scalpel Handles	71		
Schwarz, Pliers	168,175	<b>W</b>	
Schluger, File	114	Wakefield, Bone Chisels	132
Seldin, Elevator	50,55,67	Waldron, Pliers	174
Select, Tweezers	151	Waldsachs, Pliers	174
Semken, T.C. Forceps	207	Wangensteen, T.C. Forceps	208
Semkin, Tissue Forceps	158	Warwick-James, Elevator	62
Senn, Tissue Retractor	164	Waugh, Tweezers	151
Separating Pliers	166	Wax & Modeling Carvers	120
Sims, T.C. Scissors	205	Wax & Plaster Knives	127
Spatulas	123	Wax Carvers	101
Spencer, Scissors	186	Wax, Porcelain Instruments	118,119,121
Spencer-Wells, Forceps	157	Webster, Needle Holder	180,209
Spreaders	87	Weingart , Utility Pliers	167
Split Chisels,	128	Weitlaner, Retractor	160
Spring Bow Divider	143	West, Elevator	50
Standard, T.C. Scissors	201	White, Rubber Dam Instrument	147
Standard, Tweezers	151	Wieder, Tongue Depressor	160
Steiner, Pliers	166	Winter, Elevator	65,69
Sterilizing & Lab Instruments	156	Wire & Clasp Bending Pliers	170
Sterilizing Forceps,	163	Wire Bending Pliers	166
Stevens, Needle Holder	181	West, Elevator	50
Stevens, Scissors	183	Wire Cutter	165
Stille, Scissors	185	Woodson,	98
Stratte, T.C. Needle Holder	210		
Strip Holder Clips	146		
Syringes	150	<b>Y</b>	
Suction Tubes,	140,142	Young, Pliers	168,174
Sugarman, File	114		
		<b>Z</b>	
<b>T</b>		Zuricher, Measuring Instrument	143
Toennis, Wire Cutting Pliers T.C.	213	Zuricher, Gauge	143



**AFZAL**  
SURGICAL INST

---

**Address: P.O.Box # 2188, New Miana Pura East,  
St # 14, Roras Road, Sialkot-51310, Pakistan.**

**Tel: +92 52 3257285 / Fax: +92 52 3257205**

**Call/WhatsApp : +92 3227452787 / +92 3316123255**

**Email: [info@afzalsurgicalinst.com](mailto:info@afzalsurgicalinst.com)**

**Email: [afzalsurgicalinstruments@gmail.com](mailto:afzalsurgicalinstruments@gmail.com)**

**Web : [www.afzalsurgicalinst.com](http://www.afzalsurgicalinst.com)**

**Skype : meharbilal787**